



 Inhoud  3

 Contenu  4

 Inhalt  5

 Contents  6

www.menjual.com

1 • Utiliteitsbouw - binnendeuren

Keuzehulp	8	1A	Vlakrozet 2 mm ('Slimface')	77	1G
Modellen overzicht	10	1A	Metaal- & profieldeuren -	85	1H
Proline Classic - Klasse 4 & brandwerend	13	1B	Klasse 4 - DIN 18273 - EN 179		
Rozet, kort- en langschild	15	1C	Schuifdeur	99	1I
Extra brandwerend DIN 18273 - 9 mm	41	1D	Projectsloten - Klasse 3	109	1J
XL langschilden - 282 mm(L)	49	1E	Handsfree toilettentoegangsdeur voetopener	115	1K
Anti-microbe deurbeslag	120	2A	Deurgrepen	339	5A
Permafrix proline - Klasse 3 & 4	57	1F	Glasdeur	361	5B

2 • Zorg & Welzijn - binnendeuren

Infectiepreventie					
Proline antimicrobiëel deurbeslag	120	2A	Suïcide preventie	130	2C
HC3 antimicrobiële coating	126	2B			

3 • Woningen - binnendeuren

Keuzehulp	148	3A	Collectie Jaren-30 'Ton model'	265	3H
Collectie Luxuria Design	151	3B	Collectie Interior Accents	273	3I
Collectie RVS deurkrukken	181	3C	Collectie 'Black is beautiful'	289	3J
Ronde-, vierkante-, vlak- en 'Sharp Edge' rozetten	184	3D			
Vastdraaibaar op rozet zonder nokken	237	3E	Profiel deur	293	3K
Vastdraaibaar op schroefrozet	245	3F	Glasdeur	361	5B
Langschilden	255	3G	Schuifdeur	385	5D

4 • Buitendeuren

Veiligheidsbeslag	301	4A	Voordeurbeslag	327	4F
TOP breedschild SKG***	303	4B	Voordeur halfgarnituren	328	4G
PRIO smalschild SKG***	311	4C	Voordeurknoppen	330	4H
NOVA rozetten SKG*** / ES1	321	4D	Briefplaten & briefschachten	332	4I
Profiel deur rozetten	323	4E	Deurbellen	334	4J
			Huiscijfers	335	4K
Deurgrepen	339	5A	Key glow - uw slot altijd zichtbaar	336	4L

5 • Algemeen

Deurgrepen	339	5A
Glasdeurbeslag	361	5B
Deurstoppers	377	5C
Schuifdeurkommen	385	5D
Raamkrukken	389	5E
Pictogrammen	391	5F
Leuninghouders	393	5G
Jashaken	397	5H

6 • Overige informatie

Nieuwe producten	401	6A
Artitec	410	6B
Certificaten	413	6C
Maatwerk	414	6D
Bevestigingsmaterialen	416	6E
DIN Draairichtingen	417	6F
Index	418	6G
Index artikelnummers	422	6H



1. Quincaillerie bâtiment utilitaire - portes intérieures

Aide à la décision	8	1A	Rosace plate 2 mm ('Slimface')	77	1G
Vue d'ensemble des modèles	10	1A	Porte en métal & à chassis profil	85	1H
Proline Classic - Classe 4 & feu repoussant	13	1B	Classe 4 - DIN 18273 - EN 179		
Rosace, plaque courte & plaque longue	15	1C	Porte coulissante	99	1I
Feu extra repoussant DIN18273, 9 mm	41	1D	Serrures de projets - Classe 3	109	1J
Plaques longues XL - 282mm(L)	49	1E	Ouvreur de pied (mains libres), porte d'accès WC	115	1K
Quincaillerie anti-microbe	120	2A	Tirants	339	5A
Permafux proline - Classe 3 & 4	57	1F	Porte en verre	361	5B

2. Soins & Bien-être - portes intérieures

Prévention des infections					
Proline quincaillerie antimicrobien	120	2A	Prévention contre le suicide	130	2C
HC3 revêtement antimicrobien	126	2B			

3. Quincaillerie résidentielle - portes intérieures

Aide à la décision	148	3A	Collection Années-30 (modèle 'Ton')	265	3H
Collection Luxuria Design	151	3B	Collection Interior Accents	273	3I
Collection béquilles en inox	181	3C	Collection 'Black is beautiful'	289	3J
Rosaces rondes et carrées, plates & 'Sharp Edge'	184	3D			
Fixe avec ressort sur rosace sans cames	237	3E	Porte à chassis profile	293	3K
Fixe avec ressort sur rosace spirale	245	3F	Porte en verre	361	5B
Plaques longues	255	3G	Porte coulissante	385	5D

4. Portes extérieures

Quincaillerie de sécurité	301	4A	Quincaillerie pour porte d'entrée	327	4F
TOP plaque large SKG***	303	4B	Béquilles singulieres pour porte d'entrée	328	4G
PRIO plaque étroite SKG***	311	4C	Boutons pour porte d'entrée	330	4H
NOVA rosaces SKG*** / ES1	321	4D	Plaques de lettre & arbre de boîte aux lettres	332	4I
Rosaces pour portes métal & à chassis profil	323	4E	Sonnets	334	4J
			Chiffres de la maison	335	4K
Tirants	339	5A	Key glow - votre serrure toujours visible	336	4L

5 • General

Tirants	339	5A
Porte en verre	361	5B
Arrêts de porte	377	5C
Cuvettes pour porte coulissante	385	5D
Béquilles de fenêtre	389	5E
Symboles	391	5F
Supports de la rampe	393	5G
Patères manteau	397	5H

6 • Autre information

Nouveautés	401	6A
Artitec	410	6B
Certificats	413	6C
Produits faites à mesures	414	6D
Accessoires de fixation	416	6E
DIN sens de rotation	417	6F
Index	418	6G
Index codes d'article	422	6H



1. Objektbeschläge - Innentüren

Wahlhilfe	8	1A	Flachrosette 2 mm ('Slimface')	77	1G
Modellen Übersicht	10	1A	Metall & Schmalrahmen	85	1H
Proline Classic - Klasse 4 & Feuerschutz 1634-2	13	1B	Klasse 4 - DIN 18273 - EN 179		
Rosette, Kurz- und Langschild	15	1C	Schiebetür	99	1I
Feuerschutz laut DIN 18273, 9 mm	41	1D	Einsteckschlösser - Klasse 3	109	1J
XL Langschilder (282mmL)	49	1E	Handenfrei öffentliche Toilettenzugangstür	115	1K
Anti-microbe Türbeschläge	120	2A	Stoßgriffe	339	5A
Permafux proline - Klasse 3 & 4	57	1F	Glastür	361	5B

2. Pflege & Wohl - Innentüren

Infektionsprävention					
Proline antimikrobielle Türbeschläge	121	2A	Suicid-hemmend	131	2C
HC3 antimikrobielle Beschichtung	127	2B			

3. Wohnbereich - Innentüren

Wahlhilfe	148	3A	Kollektion Jahre-30 (Modell 'Ton')	265	3H
Kollektion Luxuria Design	151	3B	Kollektion Interior Accents	273	3I
Kollektion Edelstahl Türdrücker	181	3C	Collectie 'Black is beautiful'	289	3J
Runde & eckige, 2 mm Flach, 'Sharp Edge' Rosetten	184	3D			
Festdrehbar auf Rosette ohne Nocken	237	3E	Schmalrahmen	293	3K
Festdrehbar auf Überschraubrosette	245	3F	Glastür	361	5B
Langschilder	255	3G	Schiebetür	385	5D

4. Außentüren

Schutzbeschläge	301	4A	Haustürbeschläge	327	4F
TOP Schutz-Langschild SKG***	303	4B	Haustür Halbgarnituren	328	4G
PRIO Schutz-Schmalschild SKG***	311	4C	Türkнопfe	330	4H
NOVA Schutzrosetten SKG*** / ES1	321	4D	Briefeinwürfe & Briefeinwurfschaft	332	4I
Schmalrahmen Rosetten	323	4E	Türklingel	334	4J
			Hausnummer & Buchstaben	335	4K
Stoßgriffe	339	5A	Key glow - Ihr Schloß immer sichtbar	336	4L

5 • Allgemein

Stoßgriffe	339	5A
Glastürbeschläge	361	5B
Türstopper	377	5C
Schiebetürmuschel	385	5D
Fenstergriffe	389	5E
Symbole	391	5F
Handlaufstütze	393	5G
Mantelhaken	397	5H

6 • Übrige Information

Neuheiten	401	6A
Artitec	411	6B
Zertifikaten	413	6C
Sonderfertigung	415	6D
Befestigungsmaterial	416	6E
DIN Drehrichtung	417	6F
Index	418	6G
Index artikelnummern	422	6H



1. Commercial rated door furniture - Interior doors

Navigator	8	1A	Flat rose 2 mm ('Slimface')	77	1G
Model overview	10	1A	Metal doors & profile doors	85	1H
Proline Classic - Grade 4 & Fire rated EN 1634-2	13	1B	Grade 4 - DIN 18273 - EN 179		
Rose, short plate & long plate	15	1C	Sliding door	99	1I
Fire rated as per DIN 18273, 9 mm	41	1D	Mortice locks - Grade 3	109	1J
Long plates XL (282mmL)	49	1E	Handsfree public toilet entry door footopener	115	1K
Anti-Microbe doorfurniture	120	2A	Pullhandles	339	5A
Permafux proline - Grade 3 & 4	57	1F	Glass door	361	5B

2. Care & Welfare - Interior doors

Infection prevention					
Proline anti-microbial door furniture	121	2A	Anti-ligature fittings	131	2C
HC3 anti-microbial coating	127	2B			

3. Residential door furniture - Interior doors

Navigator	148	3A	Collection 1930th (Ton model)	265	3H
Collection Luxuria Design	151	3B	Collection Interior Accents	273	3I
Collection stainless steel levers:	181	3C	Collection 'Black is beautiful'	289	3J
Round & square, flat 2mm, 'Sharp Edge' roses	184	3D			
Fixed with spring on rose without lugs	237	3E	Profile door	293	3K
Fixed with spring on threaded rose	245	3F	Glass door	361	5B
Long plates	255	3G	Sliding door	385	5D

4. Exterior doors

Security hardware	301	4A	Entry door hardware	327	4F
TOP wide long plate SKG***	303	4B	Single levers for entry door	328	4G
PRIO narrow long plate SKG***	311	4C	Entry door knobs	330	4H
NOVA escutcheons SKG*** / ES1	321	4D	Letter plates + letterplate shaft	332	4I
Narrow roses for metal & profile doors	323	4E	Doorbell	334	4J
			House numbers and letters	335	4K
Pull handles	339	5A	Key glow - your lock always visible	336	4L

5 • General

Pull handles	339	5A
Glass door	361	5B
Doorstops	377	5C
Sliding pulls	385	5D
Window levers	389	5E
Graphic symbols	391	5F
Railing support holders	393	5G
Coat hooks	397	5H

6 • Other information

Novelties	401	6A
Artitec	411	6B
Certificates	413	6C
Custom made production	415	6D
Fixing material	416	6E
DIN turn direction	417	6F
Index	418	6G
Index article numbers	422	6H



Utiliteitsbouw - binnendeuren



Quincaillerie bâtiment utilitaire - Portes intérieures



Objektbeschläge - Innentüren













Commercial doorfurniture - Interior doors

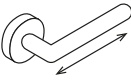

1B

			Proline Classic	Permafix proline		Slimface 2 mm
	Klasse / Classe / Grade		4 ≈ '5'	4	3	-
						-
	EN 1634-2		✓	✓	✓	-
	DIN18273		9 mm			-
			✓			
			✓			
			✓			
			✓			
			✓	✓		
			✓	✓		
					✓	✓

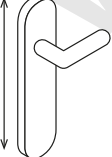
	Proline Classic	Permafix proline	Slimface 2 mm
 EN 1906 Klasse / Classe / Grade	4 ≈ '5'	4	3
			
 EN 1634-2	✓	✓	✓
 DIN18273	9 mm		
	✓	✓	✓
 2 mm	✓		✓
 XL	✓		
	✓		
	✓		
 XL	✓		

1B



Boda 4		16
Boda 169,5 mm 4		18
Leona 4		66
Leona 3		67

Boda Ø16 mm 80

Boda **4**



21

Boda **4**



20



Chase 4		22
Chase 180 mm 4		24
Chase 9 mm 4		44
Cecil 4		62
Cecil 3		63

Chase **4**



27

Chase **4**



26

Chase 9 mm **4**



45



Tessa 4		28
Tessa 9 mm 4		46
Tavira 4		70
Tavira 3		71

Tessa Ø16 mm 81

Tessa **4**



29

Tessa **4**



30

Tessa 9 mm **4**



47



Boda XL **4** 

52



Boda **4** 

88



Chase XL **4** 

53



Chase **4** 

89

Chase 9 mm **4** 

89



Chase II **4** 

90

Chase II 9 mm **4** 

90



Cindy **4** 

91

Cindy 9 mm **4** 

91



Tessa **4** 

92



Tessa II **4** 

93

Tessa II 9 mm **4** 

93



Tessa Detour **4** 

94

Tessa Detour 9 mm **4** 

94



Rondo **4** 

95

Rondo 9 mm **4** 

95

1B



Champ 4	32	Fame 4	34	Bauhaus 4	60	Noa 4	68
Fabio 4		Fabio 4	64	Bauhaus 3	61	Noa 3	69
Fabio 3			65				



Chase	102	Chase	103	Chase	104
-------------	-----	-------------	-----	-------------	-----

Proline Classic EN1906-4





Project: DUO
Architect: Unstudio



Boda 4

16



Boda 169,5 mm

18

4



Boda 4

21



Boda 4

20



Chase 4

22



Chase 180 mm 4

24



Chase 4

27



Chase 4

26



Tessa 4

28



Tessa 4

29



Tessa 4

30



Champ 4

32



Fame 4

34

Componenten / Composants / Zubehör / Components 36

Boda EN91030

Proline Classic EN1906-4



1C

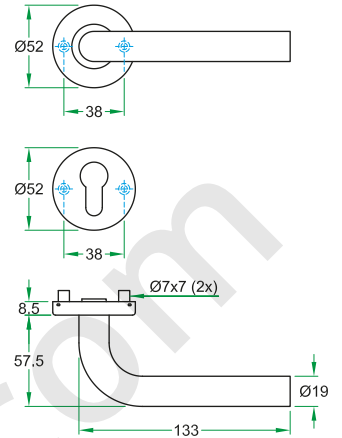

- 10 jaar garantie
- Hoogste norm: EN1906 Klasse 4 "Klasse 5" zware krachttoepassing
- RVS deurkruk vastdraaibaar met veer
- Stalen onderconstructie
- Brand-/rookwerend (EN1634-2)



- 10 ans de garantie
- La plus haute norme: EN1906 Classe 4 "Classe 5" pour usage intensif
- Béquille en inox fixe avec ressort
- Sous-construction en acier
- Feu/fumée repoussante (EN1634-2)



- 10 Jahre Garantie
- Höchste Norm: EN1906 Klasse 4 'Klasse 5' für schwere Betätigung
- Edelstahl Drücker festdrehbar mit Hochhaltefeder
- Stahl Unterkonstruktion
- Feuer- & Rauchschutz (EN1634-2)



- 10 year guarantee
- Highest standard: EN1906 Grade 4 "Grade 5" for heavy duty use
- Stainless steel doorlever sprungloaded
- Steel understructure
- Fire- & smoke rated (EN1634-2)



		EN91030R05.38
		EN91030R05.28
		EN91030R05.58

		8 mm	EN91030R05.688
		8 mm	EN91030R05.681

		8 mm	EN91030R05.68H
		8 mm	EN91030R05.68H1

Boda EN91030

Proline Classic EN1906-4

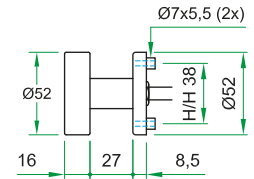





1C



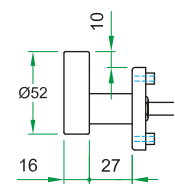
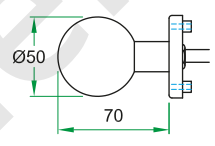
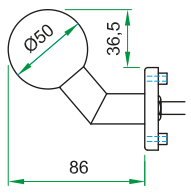

	EN91030R05.88
---	----------------------







	EN91030R05.98
--	----------------------



		EN91030R05.882
		EN91030R05.982

		EN91030R05.883
		EN91030R05.983

		EN91030R05.881
		EN91030R05.981

Boda EN91029

Proline Classic EN1906-4



1C



169,5 mm

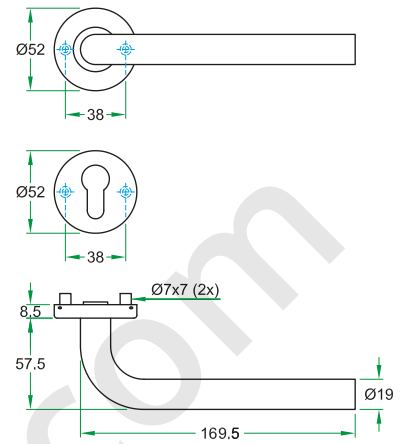

- Voldoet aan Nederlandse Integrale Toegankelijkheids standaard (ITS)
- Gecertificeerd als deurkruk type 3B
- Hoogste norm: EN1906 Klasse 4
- RVS deurkruk vastdraaibaar met veer
- Stalen onderconstructie
- Brand-/rookwerend (EN1634-2)



- Rempli à la norme integrale d'accessibilité hollandaise (ITS)
- Certifié officiel com béquille type 3B
- La plus haut norme: EN1906 Classe 4
- Béquille en inox fixe avec ressort
- Sous-construction en acier
- Feu/fumée repoussante (EN1634-2)



- Entspricht der integralen holländischen Zugänglichkeitsnorm (ITS)
- Offiziell geprüft als Türdrücker Type 3B
- Höchste Norm: EN1906 Klasse 4
- Edelstahl Drücker festdrehbar mit Hochhaltefeder
- Stahl Unterkonstruktion
- Feuer- & Rauchschutz (EN1634-2)



- Conforms to the Dutch integral accessibility standard (ITS)
- Certified as door handle type 3B
- Highest standard: EN1906 Grade 4
- Stainless steel door lever sprungloaded
- Steel understructure
- Fire- & smoke rated (EN1634-2)

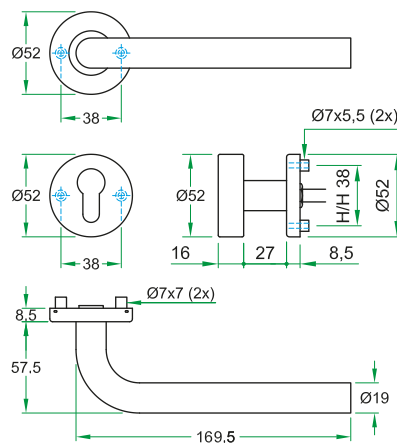

	EN91029R05.88
	EN91029R05.98

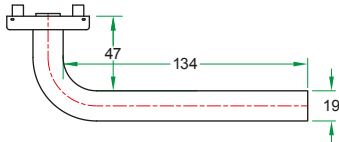
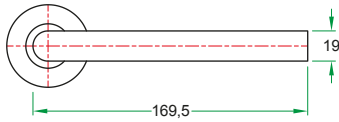

VERKLARING 3B OBJECT

PBTaudit, onderdeel van PBTconsult BV, verklaart hierbij

dat het ontwerp van de hieronder vermelde producten voldoet aan de toegankelijkheidseisen zoals gesteld in de Nederlandse Integrale Toegankelijkheidsstandaard (ITS).

Oprachtgever	Artitec bv Fornheselaan 120 3734 GE Den Dolder
3B-Type	4.4.1 Deurkruk 4.4.2 Deurgreep
Productomschrijving	EN91055R05.X8 Model Chase rvs deurkruk 180mmL vastdraaibaar met veer op rozet ø52mm EN91029R05.X8 Model Boda deurkruk 169,5mmL vastdraaibaar met veer op rozet ø52mm PH60 horizontale rvs deurgreep/muurbeugel ø32mm, wandsterkte 1,5mm, h/h 800mm
3B-certificaatnummer	3B-442-014
Bijlage(n)	-
Opgesteld	1 december 2016
Geldig tot	n.v.t.
Opmerkingen	Het is de verantwoordelijkheid van de fabrikant te onderzoeken welke andere Nederlandse normen en richtlijnen tevens van toepassing zijn op dit product. De fabrikant of zijn gevestigde gevolmachtigde dient PBTconsult BV op de hoogte te brengen van alle, zelfs geringe, wijzigingen, die betrekking hebben of kunnen hebben op het gebruik van de hierboven beschreven producten, die hij heeft aangebracht of overweegt aan te brengen aan deze producten. PBTaudit onderzoekt deze wijzigingen en deelt de fabrikant of diens gemachtigde mee of de verklaring 3B Object geldig blijft.

W. Jagersma
Directeur

PBTaudit | Postbus 2420 | 3500 GK Utrecht
T: 030 - 291 66 33 | I: www.pbtaudit.nl | E: info@pbtaudit.nl
IBAN NL13TRIO0197600735 | KvK: 32110854 | BTW: 817124305B01



Boda EN91030

Proline Classic EN1906-4



1C

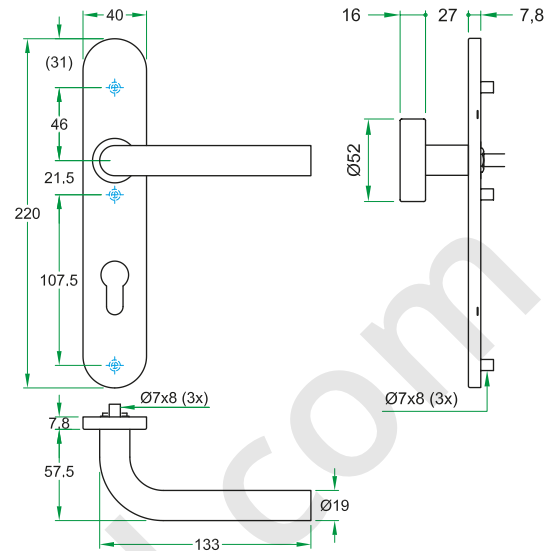
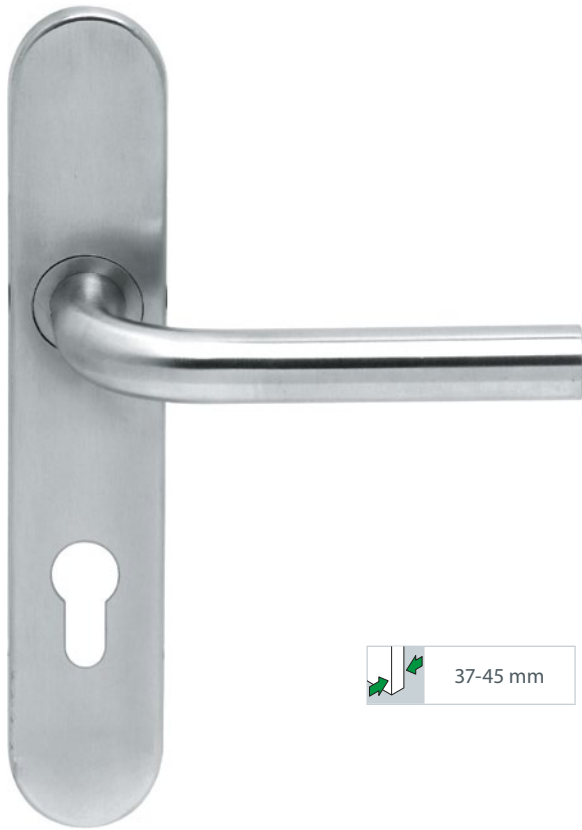

- 10 jaar garantie
- Hoogste norm: EN1906 Klasse 4 "Klasse 5" zware krachttoepassing
- RVS deurkruk vastdraaibaar met veer
- Stalen onderconstructie
- Brand-/rookwerend (EN1634-2)
- Andere stansmaten mogelijk



- 10 ans de garantie
- La plus haute norme: EN1906 Classe 4 "Classe 5" pour usage intensif
- Béquille en inox fixe avec ressort
- Sous-construction en acier
- Feu/fumée repoussante (EN1634-2)
- Possibilité d'adapter pour différents trous de serrure



- 10 Jahre Garantie
- Höchste Norm: EN1906 Klasse 4 'Klasse 5' für schwere Betätigung
- Edelstahl Drücker festdrehbar mit Hochhaltefeder
- Stahl Unterkonstruktion
- Feuer-/Rauchschutz (EN1634-2)
- Andere Entfernungen möglich



- 10 year guarantee
- Highest standard: EN1906 Grade 4 "Grade 5" for heavy duty use
- Fire- & smoke rated (EN1634-2)
- Stainless steel doorlever sprungloaded
- Steel understructure
- Other key hole options possible



	○ ○	-	EN91030B00.58
	⊕ ⊕	55 mm	EN91030B55.38
	⊕ ⊕	72 mm	EN91030B72.38
	⊕ ⊕	56 mm	EN91030B56.28
	⊕ ⊕	72 mm	EN91030B72.28

	⊕ ⊕	72/8 mm	EN91030B72.688
--	-----	---------	----------------

	⊕ ⊕	72 mm	EN91030B72.88
	○ ○	-	EN91030B00.88
	⊕ ⊕	72 mm	EN91030B72.98
	○ ○	-	EN91030B00.98

Boda EN91030

Proline Classic EN1906-4

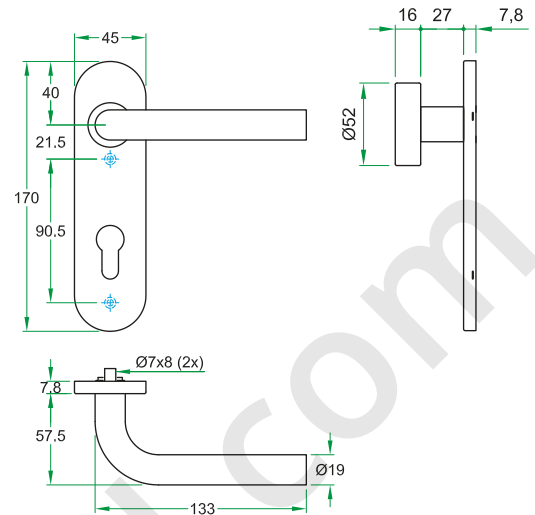

- 10 jaar garantie
- Hoogste norm: EN1906 Klasse 4 "Klasse 5" zware krachttoepassing
- RVS deurkruk vastdraaibaar met veer
- Stalen onderconstructie
- Brand-/rookwerend (EN1634-2)
- Andere stansmaten mogelijk



- 10 ans de garantie
- La plus haute norme: EN1906 Classe 4 "Classe 5" pour usage intensif
- Béquille en inox fixe avec ressort
- Sous-construction en acier
- Feu/fumée repoussante (EN1634-2)
- Possibilité d'adapter pour différents trous de serrure



- 10 Jahre Garantie
- Höchste Norm: EN1906 Klasse 4 'Klasse 5' für schwere Betätigung
- Edelstahl Drücker festdrehbar mit Hochhaltefeder
- Stahl Unterkonstruktion
- Feuer-/Rauchschutz (EN1634-2)
- Andere Entfernungen möglich



- 10 year guarantee
- Highest standard: EN1906 Grade 4 "Grade 5" for heavy duty use
- Fire- & smoke rated (EN1634-2)
- Stainless steel doorlever sprungloaded
- Steel understructure
- Other key hole options possible



	○ ○	-	EN91030K00.58
	⊕ ⊕	55 mm	EN91030K55.38
	⊕ ⊕	72 mm	EN91030K72.38
	⊕ ⊕	56 mm	EN91030K56.28
	⊕ ⊕	72 mm	EN91030K72.28

	⊕ ⊕	72/8 mm	EN91030K72.688
--	-----	---------	----------------

	⊕ ⊕	72 mm	EN91030K72.88
	⊕ ⊕	72 mm	EN91030K72.98

Chase EN91050

Proline Classic EN1906-4



1C

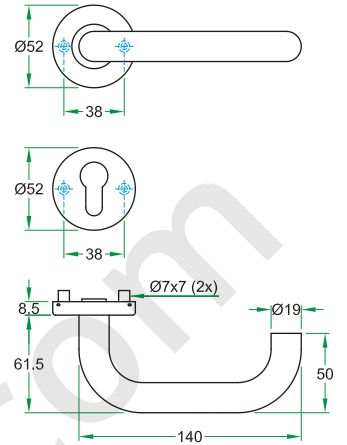

- 10 jaar garantie
- Hoogste norm: EN1906 Klasse 4 "Klasse 5" zware krachttoepassing
- RVS deurkruk vastdraaibaar met veer
- Stalen onderconstructie
- Brand-/rookwerend (EN1634-2)



- 10 ans de garantie
- La plus haute norme: EN1906 Classe 4 "Classe 5" pour usage intensif
- Béquille en inox fixe avec ressort
- Sous-construction en acier
- Feu/fumée repoussante (EN1634-2)



- 10 Jahre Garantie
- Höchste Norm: EN1906 Klasse 4 'Klasse 5' für schwere Betätigung
- Edelstahl Drücker festdrehbar mit Hochhaltefeder
- Stahl Unterkonstruktion
- Feuer- & Rauchschutz (EN1634-2)



- 10 year guarantee
- Highest standard: EN1906 Grade 4 "Grade 5" for heavy duty use
- Stainless steel doorlever sprungloaded
- Steel understructure
- Fire- & smoke rated (EN1634-2)



		EN91050R05.38
		EN91050R05.28
		EN91050R05.58



		8 mm	EN91050R05.688
		8 mm	EN91050R05.681



		8 mm	EN91050R05.68H
		8 mm	EN91050R05.68H1

Chase EN91050

Proline Classic EN1906-4

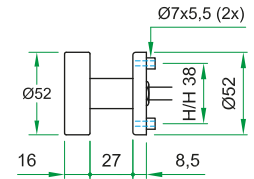

1C

 L		EN91050R05.88
--	---	----------------------

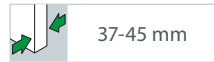

 R		EN91050R05.98
---	---	----------------------

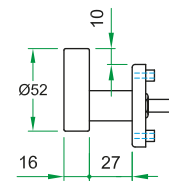
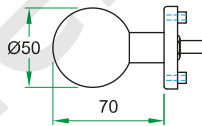
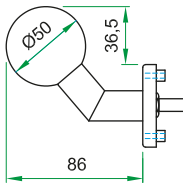

 L		EN91050R05.882
 R		EN91050R05.982

 L		EN91050R05.883
 R		EN91050R05.983

 L		EN91050R05.881
 R		EN91050R05.981

Chase EN91055

Proline Classic EN1906-4



1C



180 mm

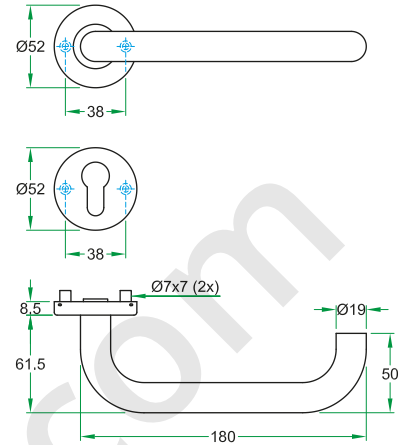

- Voldoet aan Nederlandse Integrale Toegankelijkheids standaard (ITS)
- Gecertificeerd als deurkruk type 3B
- Hoogste norm: EN1906 Klasse 4
- RVS deurkruk vastdraaibaar met veer
- Stalen onderconstructie
- Brand-/rookwerend (EN1634-2)



- Rempli à la norme integrale d'accessibilité hollandaise (ITS)
- Certifié officiel com béquille type 3B
- La plus haut norme: EN1906 Classe 4
- Béquille en inox fixe avec ressort
- Sous-construction en acier
- Feu/fumée repoussante (EN1634-2)



- Entspricht der integralen holländischen Zugänglichkeitsnorm (ITS)
- Offiziell geprüft als Türdrücker Type 3B
- Höchste Norm: EN1906 Klasse 4
- Edelstahl Drücker festdrehbar mit Hochhaltefeder
- Stahl Unterkonstruktion
- Feuer- & Rauchschutz (EN1634-2)



- Conforms to the Dutch integral accessibility standard (ITS)
- Certified as door handle type 3B
- Highest standard: EN1906 Grade 4
- Stainless steel door lever sprungloaded
- Steel understructure
- Fire- & smoke rated (EN1634-2)

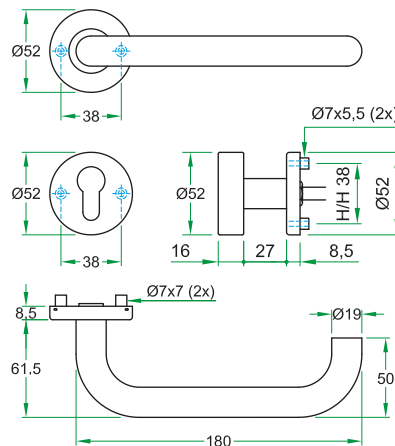

 L	EN91055R05.88
 R	EN91055R05.98

Chase EN91055

3B-certificaat nr. 3B-442-014

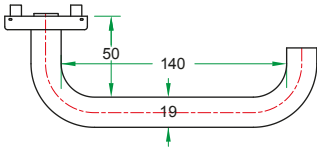
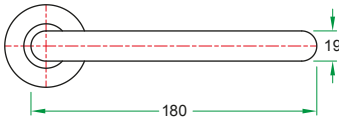

VERKLARING 3B OBJECT

PBTaudit, onderdeel van PBTconsult BV, verklaart hierbij

dat het ontwerp van de hieronder vermelde producten voldoet aan de toegankelijkheidseisen zoals gesteld in de Nederlandse Integrale Toegankelijkheidsstandaard (ITS).

Oprachtgever	Artitec bv Fornheselaan 120 3734 GE Den Dolder
3B-Type	4.4.1 Deurkruk 4.4.2 Deurgreep
Productomschrijving	EN91055R05.X8 Model Chase rvs deurkruk 180mmL vastdraaibaar met veer op rozet ø52mm EN91029R05.X8 Model Boda deurkruk 169,5mmL vastdraaibaar met veer op rozet ø52mm PH60 horizontale rvs deurgreep/muurbeugel ø32mm, wandsterkte 1,5mm, h/h 800mm
3B-certificaatnummer	3B-442-014
Bijlage(n)	-
Opgesteld	1 december 2016
Geldig tot	n.v.t.
Opmerkingen	Het is de verantwoordelijkheid van de fabrikant te onderzoeken welke andere Nederlandse normen en richtlijnen tevens van toepassing zijn op dit product. De fabrikant of zijn gevestigde gevolmachtigde dient PBTconsult BV op de hoogte te brengen van alle, zelfs geringe, wijzigingen, die betrekking hebben of kunnen hebben op het gebruik van de hierboven beschreven producten, die hij heeft aangebracht of overweegt aan te brengen aan deze producten. PBTaudit onderzoekt deze wijzigingen en deelt de fabrikant of diens gemachtigde mee of de verklaring 3B Object geldig blijft.

W. Jagersma
Directeur

PBTaudit | Postbus 2420 | 3500 GK Utrecht
T: 030 - 291 66 33 | I: www.pbtaudit.nl | E: info@pbtaudit.nl
IBAN NL13TRIO0197600735 | KvK: 32110854 | BTW: 817124305B01



Chase EN91050

Proline Classic EN1906-4



1C

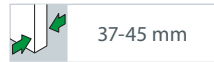
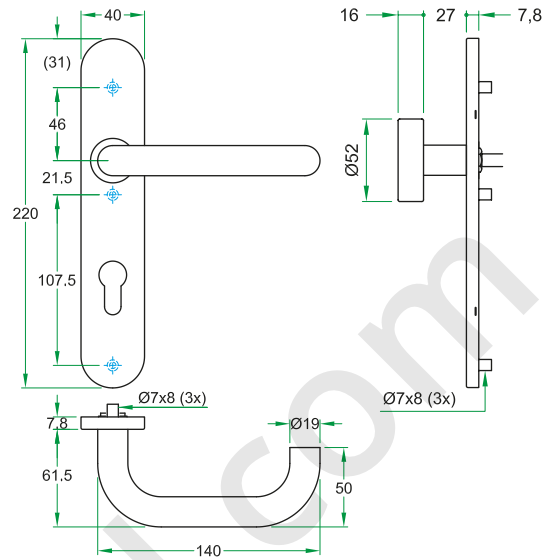
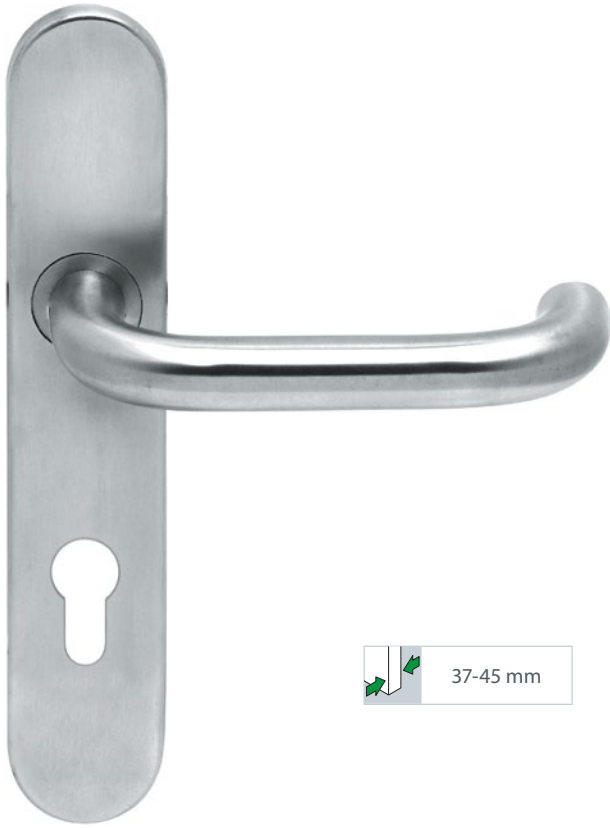

- 10 jaar garantie
- Hoogste norm: EN1906 Klasse 4 "Klasse 5" zware krachttoepassing
- RVS deurkruk vastdraaibaar met veer
- Stalen onderconstructie
- Brand-/rookwerend (EN1634-2)
- Andere stansmaten mogelijk



- 10 ans de garantie
- La plus haute norme: EN1906 Classe 4 "Classe 5" pour usage intensif
- Béquille en inox fixe avec ressort
- Sous-construction en acier
- Feu/fumée repoussante (EN1634-2)
- Possibilité d'adapter pour différents trous de serrure



- 10 Jahre Garantie
- Höchste Norm: EN1906 Klasse 4 'Klasse 5' für schwere Betätigung
- Edelstahl Drücker festdrehbar mit Hochhaltefeder
- Stahl Unterkonstruktion
- Feuer-/Rauchschutz (EN1634-2)
- Andere Entfernungen möglich



- 10 year guarantee
- Highest standard: EN1906 Grade 4 "Grade 5" for heavy duty use
- Fire- & smoke rated (EN1634-2)
- Stainless steel doorlever sprungloaded
- Steel understructure
- Other key hole options possible



	○ ○	-	EN91050B00.58
	⊕ ⊕	55 mm	EN91050B55.38
	⊕ ⊕	72 mm	EN91050B72.38
	⊕ ⊕	56 mm	EN91050B56.28
	⊕ ⊕	72 mm	EN91050B72.28

	⊕ ⊕	72/8 mm	EN91050B72.688
	⊕ ⊕	72/8 mm	EN91050B72.681

	⊕ ⊕	72 mm	EN91050B72.88
	○ ○	-	EN91050B00.88
	⊕ ⊕	72 mm	EN91050B72.98
	○ ○	-	EN91050B00.98

Chase EN91050

Proline Classic EN1906-4

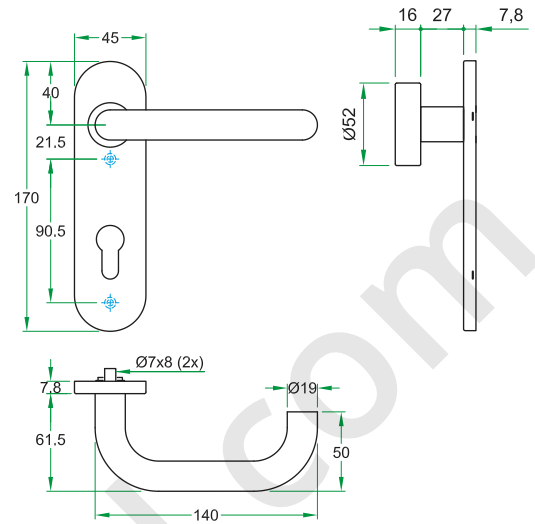

- 10 jaar garantie
- Hoogste norm: EN1906 Klasse 4 "Klasse 5" zware krachttoepassing
- RVS deurkruk vastdraaibaar met veer
- Stalen onderconstructie
- Brand-/rookwerend (EN1634-2)
- Andere stansmaten mogelijk



- 10 ans de garantie
- La plus haute norme: EN1906 Classe 4 "Classe 5" pour usage intensif
- Béquille en inox fixe avec ressort
- Sous-construction en acier
- Feu/fumée repoussante (EN1634-2)
- Possibilité d'adapter pour différents trous de serrure



- 10 Jahre Garantie
- Höchste Norm: EN1906 Klasse 4 'Klasse 5' für schwere Betätigung
- Edelstahl Drücker festdrehbar mit Hochhaltefeder
- Stahl Unterkonstruktion
- Feuer-/Rauchschutz (EN1634-2)
- Andere Entfernungen möglich



- 10 year guarantee
- Highest standard: EN1906 Grade 4 "Grade 5" for heavy duty use
- Fire- & smoke rated (EN1634-2)
- Stainless steel doorlever sprungloaded
- Steel understructure
- Other key hole options possible



	○ ○	-	EN91050K00.58
	⊕ ⊕	55 mm	EN91050K55.38
	⊕ ⊕	72 mm	EN91050K72.38
	⊙ ⊙	56 mm	EN91050K56.28
	⊙ ⊙	72 mm	EN91050K72.38

	⊕ ⊕	72/8 mm	EN91050K72.688
--	-----	---------	----------------

	⊕ ⊕	72 mm	EN91050K72.88
	⊕ ⊕	72 mm	EN91050K72.98

Tessa EN91070

Proline Classic EN1906-4



1C

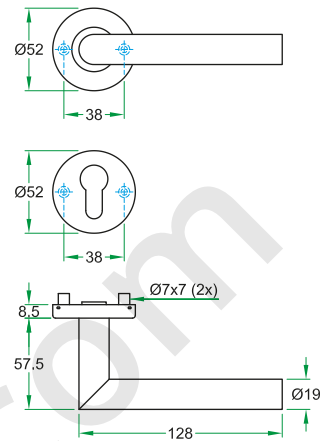

- 10 jaar garantie
- Hoogste norm: EN1906 Klasse 4 "Klasse 5" zware krachttoepassing
- RVS deurkruk vastdraaibaar met veer
- Stalen onderconstructie
- Brand-/rookwerend (EN1634-2)



- 10 ans de garantie
- La plus haute norme: EN1906 Classe 4 "Classe 5" pour usage intensif
- Béquille en inox fixe avec ressort
- Sous-construction en acier
- Feu/fumée repoussante (EN1634-2)



- 10 Jahre Garantie
- Höchste Norm: EN1906 Klasse 4 'Klasse 5' für schwere Betätigung
- Edelstahl Drücker festdrehbar mit Hochhaltefeder
- Stahl Unterkonstruktion
- Feuer- & Rauchschutz (EN1634-2)



- 10 year guarantee
- Highest standard: EN1906 Grade 4 "Grade 5" for heavy duty use
- Stainless steel doorlever sprungloaded
- Steel understructure
- Fire- & smoke rated (EN1634-2)



		EN91070R05.38
		EN91070R05.28
		EN91070R05.58

		8 mm	EN91070R05.688
		8 mm	EN91070R05.681

		8 mm	EN91070R05.68H
		8 mm	EN91070R05.68H1

Tessa EN91070

Proline Classic EN1906-4

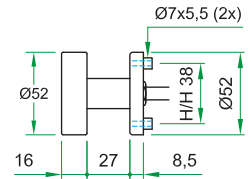

1C

 L			EN91070R05.88
--	---	---	----------------------

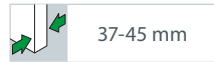

 R			EN91070R05.98
---	---	---	----------------------

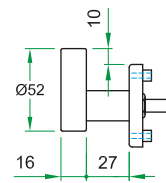
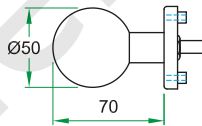
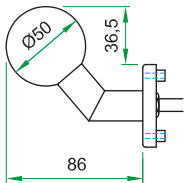

 L			EN91070R05.882
 R			EN91070R05.982

 L			EN91070R05.883
 R			EN91070R05.983

 L			EN91070R05.881
 R			EN91070R05.981

Tessa EN91070

Proline Classic EN1906-4



1C

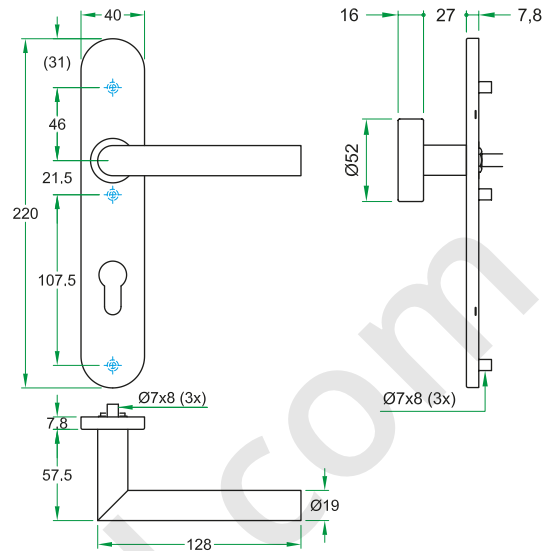

- 10 jaar garantie
- Hoogste norm: EN1906 Klasse 4 "Klasse 5" zware krachttoepassing
- RVS deurkruk vastdraaibaar met veer
- Stalen onderconstructie
- Brand-/rookwerend (EN1634-2)
- Andere stansmaten mogelijk



- 10 ans de garantie
- La plus haute norme: EN1906 Classe 4 "Classe 5" pour usage intensif
- Béquille en inox fixe avec ressort
- Sous-construction en acier
- Feu/fumée repoussante (EN1634-2)
- Possibilité d'adapter pour différents trous de serrure



- 10 Jahre Garantie
- Höchste Norm: EN1906 Klasse 4 'Klasse 5' für schwere Betätigung
- Edelstahl Drücker festdrehbar mit Hochhaltefeder
- Stahl Unterkonstruktion
- Feuer-/Rauchschutz (EN1634-2)
- Andere Entfernungen möglich



- 10 year guarantee
- Highest standard: EN1906 Grade 4 "Grade 5" for heavy duty use
- Fire- & smoke rated (EN1634-2)
- Stainless steel doorlever sprungloaded
- Steel understructure
- Other key hole options possible



	○ ○	-	EN91070B00.58
	⊕ ⊕	55 mm	EN91070B55.38
	⊕ ⊕	72 mm	EN91070B72.38
	⊗ ⊗	56 mm	EN91070B56.28
	⊗ ⊗	72 mm	EN91070B72.28

	⊗ ⊗	72/8 mm	EN91070B72.688
--	-----	---------	----------------

	⊕ ⊕	72 mm	EN91070B72.88
	○ ○	-	EN91070B00.88
	⊕ ⊕	72 mm	EN91070B72.98
	○ ○	-	EN91070B00.98

Tessa EN91070

Proline Classic EN1906-4

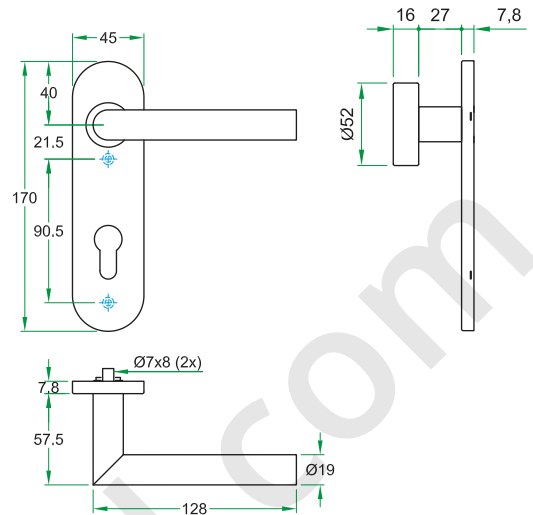
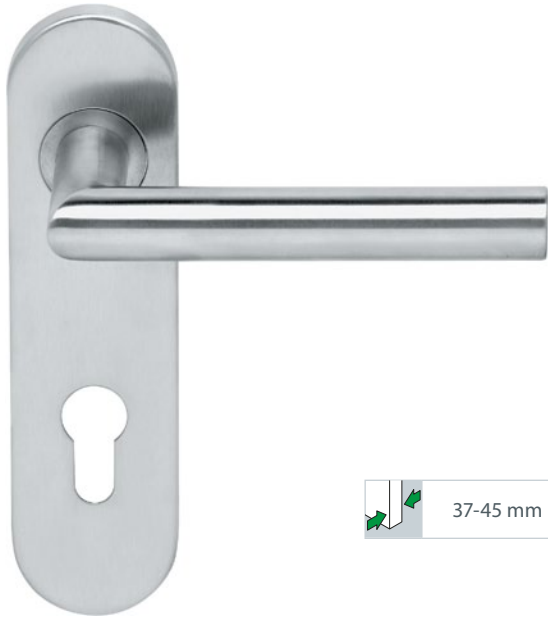

- 10 jaar garantie
- Hoogste norm: EN1906 Klasse 4 "Klasse 5" zware krachttoepassing
- RVS deurkruk vastdraaibaar met veer
- Stalen onderconstructie
- Brand-/rookwerend (EN1634-2)
- Andere stansmaten mogelijk



- 10 ans de garantie
- La plus haute norme: EN1906 Classe 4 "Classe 5" pour usage intensif
- Béquille en inox fixe avec ressort
- Sous-construction en acier
- Feu/fumée repoussante (EN1634-2)
- Possibilité d'adapter pour différents trous de serrure



- 10 Jahre Garantie
- Höchste Norm: EN1906 Klasse 4 "Klasse 5" für schwere Betätigung
- Edelstahl Drücker festdrehbar mit Hochhaltefeder
- Stahl Unterkonstruktion
- Feuer-/Rauchschutz (EN1634-2)
- Andere Entfernungen möglich



- 10 year guarantee
- Highest standard: EN1906 Grade 4 "Grade 5" for heavy duty use
- Fire- & smoke rated (EN1634-2)
- Stainless steel doorlever sprungloaded
- Steel understructure
- Other key hole options possible



	○ ○	-	EN91070K00.58
	⊕ ⊕	55 mm	EN91070K55.38
	⊕ ⊕	72 mm	EN91070K72.38
	⊕ ⊕	56 mm	EN91070K56.28
	⊕ ⊕	72 mm	EN91070K72.38

	⊕ ⊕	72/8 mm	EN91070K72.688
--	-----	---------	----------------

	⊕ ⊕	72 mm	EN91070K72.88
	⊕ ⊕	72 mm	EN91070K72.98

Champ EN91078

Proline Classic EN1906-4



1C

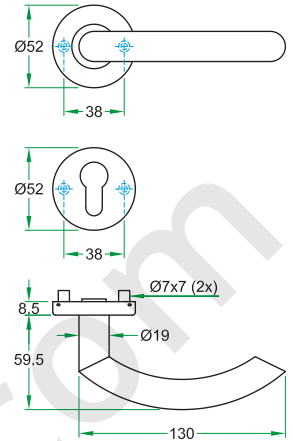

- 10 jaar garantie
- Hoogste norm: EN1906 Klasse 4 "Klasse 5" zware krachttoepassing
- RVS deurkruk vastdraaibaar met veer
- Stalen onderconstructie
- Brand-/rookwerend (EN1634-2)



- 10 ans de garantie
- La plus haute norme: EN1906 Classe 4 "Classe 5" pour usage intensif
- Béquille en inox fixe avec ressort
- Sous-construction en acier
- Feu/fumée repoussante (EN1634-2)



- 10 Jahre Garantie
- Höchste Norm: EN1906 Klasse 4 'Klasse 5' für schwere Betätigung
- Edelstahl Drücker festdrehbar mit Hochhaltefeder
- Stahl Unterkonstruktion
- Feuer- & Rauchschutz (EN1634-2)



- 10 year guarantee
- Highest standard: EN1906 Grade 4 "Grade 5" for heavy duty use
- Stainless steel doorlever sprungloaded
- Steel understructure
- Fire- & smoke rated (EN1634-2)



		EN91078R05.38
		EN91078R05.28
		EN91078R05.58

		8 mm	EN91078R05.688
		8 mm	EN91078R05.681

		8 mm	EN91078R05.68H
		8 mm	EN91078R05.68H1

Champ EN91078

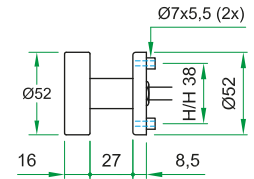

Proline Classic EN1906-4





1C

 L			EN91078R05.88
--	---	---	----------------------

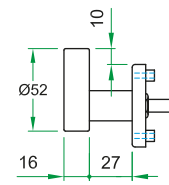
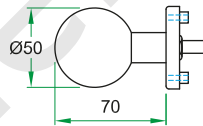
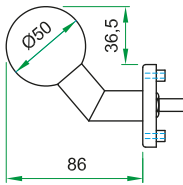

 R			EN91078R05.98
---	---	---	----------------------



 L			EN91078R05.882
 R			EN91078R05.982

 L			EN91078R05.883
 R			EN91078R05.983

 L			EN91078R05.881
 R			EN91078R05.981

Fame EN97719

Proline Classic EN1906-4



1C

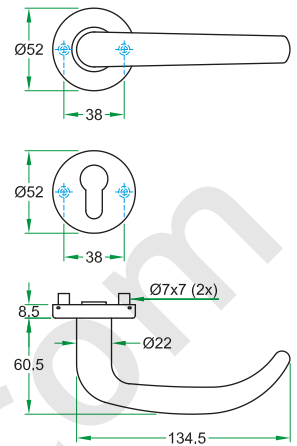

- 10 jaar garantie
- Hoogste norm: EN1906 Klasse 4 "Klasse 5" zware krachttoepassing
- RVS deurkruk vastdraaibaar met veer
- Stalen onderconstructie
- Brand-/rookwerend (EN1634-2)



- 10 ans de garantie
- La plus haute norme: EN1906 Classe 4 "Classe 5" pour usage intensif
- Béquille en inox fixe avec ressort
- Sous-construction en acier
- Feu/fumée repoussante (EN1634-2)



- 10 Jahre Garantie
- Höchste Norm: EN1906 Klasse 4 'Klasse 5' für schwere Betätigung
- Edelstahl Drücker festdrehbar mit Hochhaltefeder
- Stahl Unterkonstruktion
- Feuer- & Rauchschutz (EN1634-2)



- 10 year guarantee
- Highest standard: EN1906 Grade 4 "Grade 5" for heavy duty use
- Stainless steel doorlever sprungloaded
- Steel understructure
- Fire- & smoke rated (EN1634-2)



		EN97719R05.38
		EN97719R05.28
		EN97719R05.58



		8 mm	EN97719R05.688
		8 mm	EN97719R05.681



		8 mm	EN97719R05.68H
		8 mm	EN97719R05.68H1

Fame EN97719

Proline Classic EN1906-4

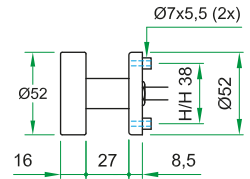

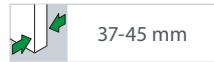

1C

	EN97719R05.88
---	----------------------

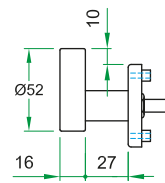
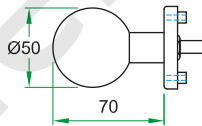
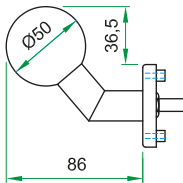

	EN97719R05.98
--	----------------------



	EN97719R05.882
	EN97719R05.982

	EN97719R05.883
	EN97719R05.983

	EN97719R05.881
	EN97719R05.981

Rozet / Rosace / Rosette / Rose • Proline Classic

1C

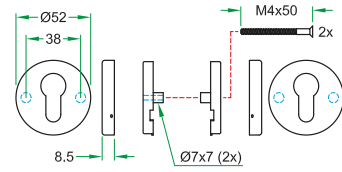

		27025			27024			27028
--	--	-------	--	--	-------	--	--	-------

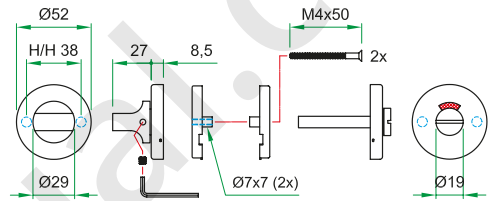

		R05.6X8			R05.6X8/1			
--	--	---------	--	--	-----------	--	--	--

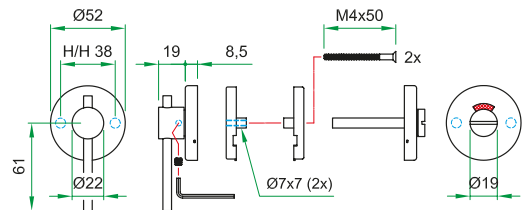
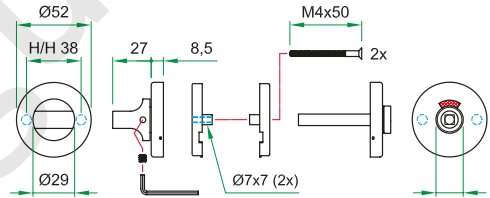

		97722			97722/1			
--	--	-------	--	--	---------	--	--	--

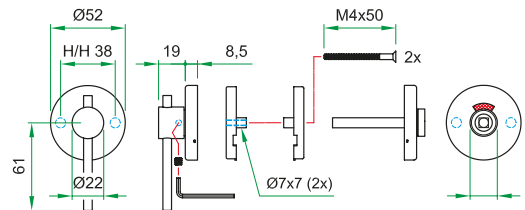

Knoppen / Boutons / Knöpfe / Knobs • Proline Classic

1C



96162 96163

- Wisselknop op rozet
- Wisselstift M12/□8 x 80 mm

- Bouton fixe sur rosace
- Tige carrée M12/□8 x 80 mm

- Wechselknopf auf Rosette
- Wechselstift M12/□8 x 80 mm

- Knob fixed on rose
- Spindle M12/□8 x 80 mm

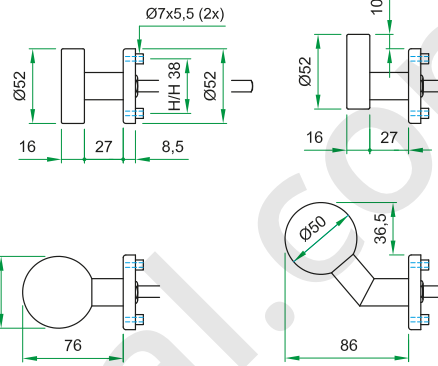

96165 96164

- Meterkastknop vast op rozet
- Afdekrozet 97803 voor doorgaande bevestiging

- Bouton fixe sur rosace
- Rosace 97803 pour fixation traversant

- Schrankknopf auf Rosette
- Abdeckrossette 97803 für durchgehende Befestigung

- Dummy closetknob on rose
- Cover rose 97803 for bolt-thru fixing

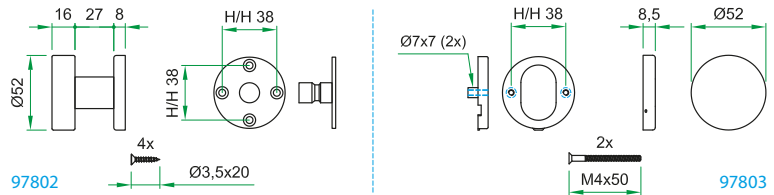

97802 97803

- Paar vaste knop op rozet
- Doorgaande bevestiging

- Paire bouton fixe à rosace
- Fixation traversant

- Paar Knöpfe fest auf Rosette
- Durchgehende Befestigung

- Pair Knobs fixed on rose
- Bolt-thru fixing

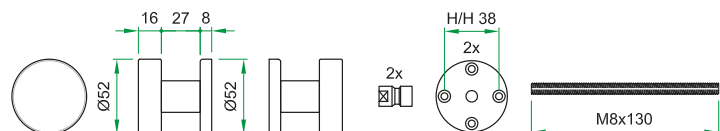

97756

1C



○	-	97809
①	56 mm	97830
②	55 mm	97808
③	72 mm	97807

○	-	97820
④	72 mm	97823



- Meterkastknop op langschild
- Afdekschild voor doorgaande bevestiging



- Bouton de compteur sur plaque longue
- Plaque pour fixation traversant



- Schrankknopf auf Langschild
- Abdeckschild für durchgehende Befestigung



- Dummy closetknob on longplate
- Cover plate for bolt-thru fixing

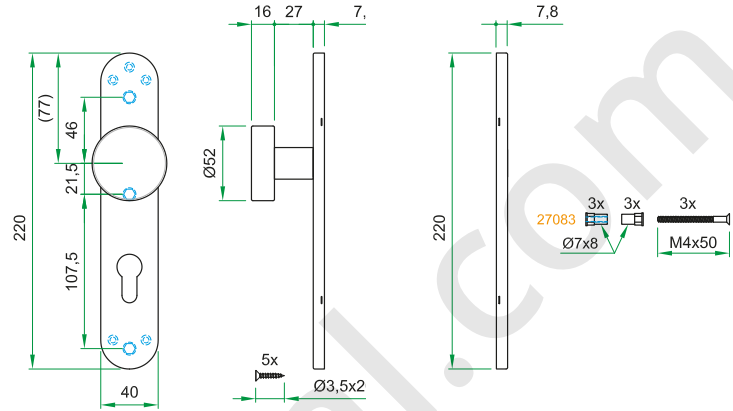

- Paar deurknop vast op langschild
- Doorgaande bevestiging



- Paire bouton fixe sur plaque longue
- Fixation traversant



- Paar Knöpfe fest auf Langschild
- Durchgehende Befestigung



- Pair knob fixed on longplate
- Bolt-thru fixing

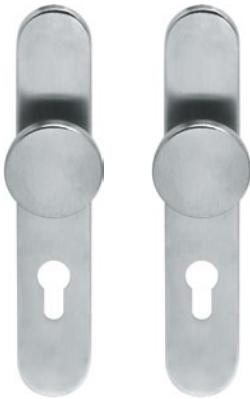

○ ○	-	97819
⑤ ⑥	72 mm	97815

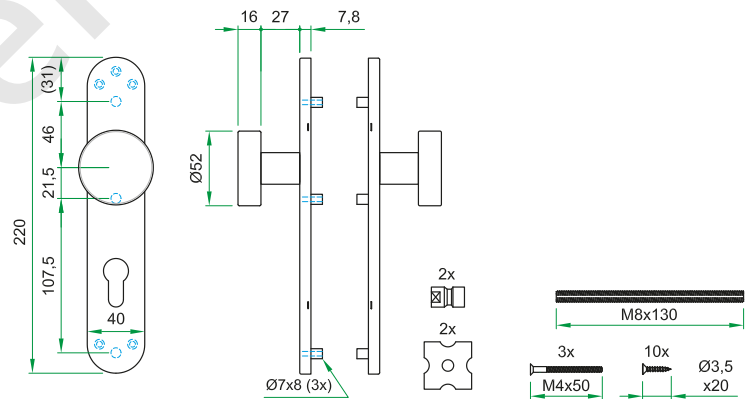

Kortschilden / Plaques / Schilder / Plates • Proline Classic



○	-	97806
①	56 mm	97822
②	55 mm	97805
③	72 mm	97804

○	-	97755
④	72 mm	97821



- Meterkastknop kortschild
- Afdekschild voor doorgaande bevestiging



- Bouton de compteur plaque courte
- Plaque pour fixation transversant



- Schrankknopf Kurzschild
- Abdeckschild für durchgehende Befestigung



- Dummy closetknob shortplate
- Cover plate for bolt-thru fixing

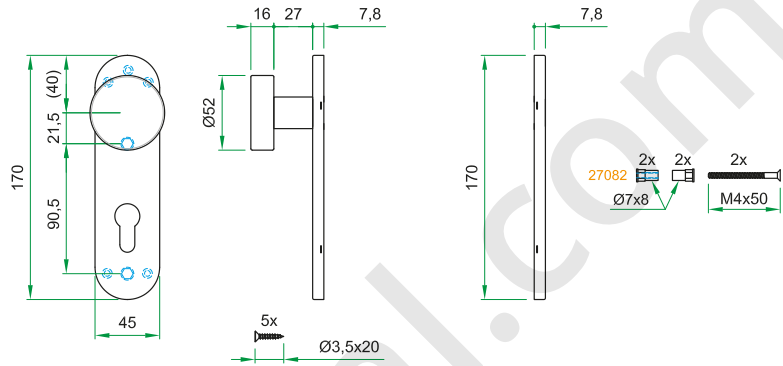

- Paar deurknop vast op kortschild
- Doorgaande bevestiging



- Paire Bouton fixe sur plaque courte
- Fixation transversant



- Paar Knöpfe fest auf Kurzschild
- Durchgehende Befestigung



- Pair knobs fixed on shortplate
- Bolt-thru fixing



○ ○	-	97814
⑤ ⑥	72 mm	97810

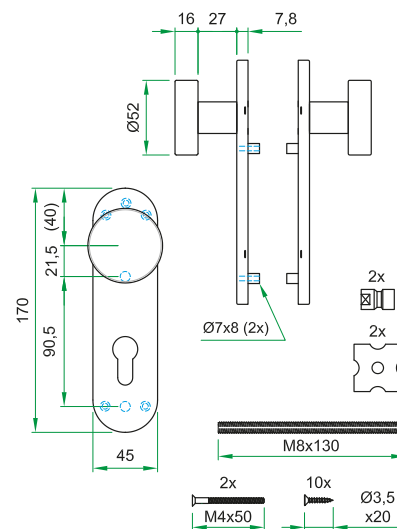

-   **ONDERDELEN Verlengde stiften en schroeven**
-   **ACCESSOIRES Tiges e vis allongées**
-  **ZUBEHÖR verlängerte Stifte und Schrauben**
-  **PARTS extended spindles and screws**



1C

Massief 45H staal
Acier 45D massif
Massiv 45H Stahl
Solid 45H Steel

□ L

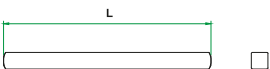
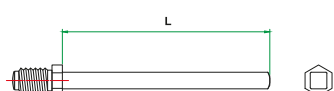

Artikelnr.
Code d'article
Artikelnr.
Article code

		M6				27027*
		□ 8 mm	✓	110 mm*	max 58 mm	93120*
		□ 8 mm	✓	130 mm	max 71 mm	93111
		□ 8 mm	✓	160 mm	max 100 mm	93120-160
		M12/□ 8 mm	✓	80 mm*	max 58 mm	93123*
		M12/□ 8 mm	✓	100 mm	max 71 mm	93127
		M12/□ 8 mm	✓	120 mm	max 91 mm	93129
	Rozet/Rosace Rosette/Rose	M4	Staal/Acier Stahl/Steel	50 mm*	36-45 mm	27029*
	Kortschild/Plaque courte Kurzschild/Shortplate	M4	Staal/Acier Stahl/Steel	50 mm*	36-45 mm	27080*
	Langschild/Plaque longue Langschild/Longplate	M4	Staal/Acier Stahl/Steel	50 mm*	36-45 mm	27081*
		M4	Staal/Acier Stahl/Steel	60 mm	46-55 mm	27084
		M4	Staal/Acier Stahl/Steel	70 mm	56-65 mm	93234-70
		M4	Staal/Acier Stahl/Steel	80 mm	66-75 mm	93234-80
		M4	Staal/Acier Stahl/Steel	90 mm	76-85 mm	93234-90
		M4	Staal/Acier Stahl/Steel	100 mm	86-95 mm	93234-100
		M4	Staal/Acier Stahl/Steel	120 mm	100 mm	93107

* Standaard meegeleverd in garnituur.

* Fourni standard avec garniture.

* Standard beim Garnitur miteinbegriffen.

* Standard included in each lever set.

Proline Classic DIN 18273





Project: Paleis van Justitie
Architect: Claus en Kaan Architecten



Chase 9 mm 44



Chase 9 mm 45



Tessa 9 mm 46



Tessa 9 mm 47

Chase 91050

Proline Classic DIN 18273



1D

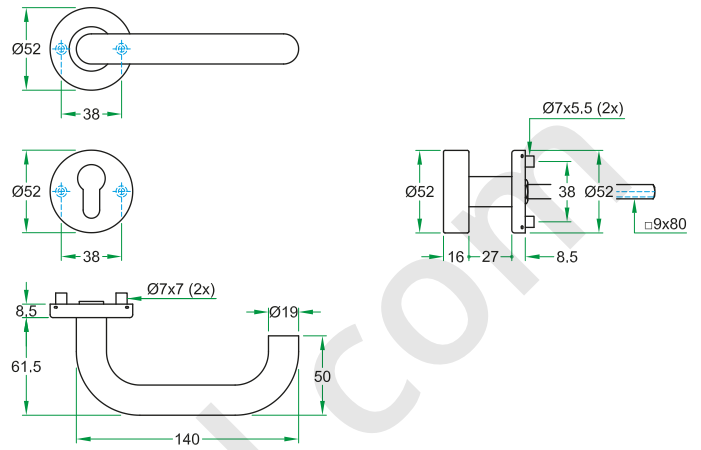

- 10 jaar garantie
- Extra-brandwerend (DIN18273)
- Getest op 1000°C
- RVS deurkruk vastdraaibaar ZONDER veer
- Stalen onderconstructie
- Krukstift 9 mm
- Hoogste norm: EN1906 Klasse 4



- 10 ans de garantie
- Feu extra repoussant (DIN18273)
- Testé à 1000°C
- Béquille fixe SANS ressort
- Sous-structure en acier
- Tige carré 9 mm
- La plus haute norme: EN1906 Classe 4



- 10 Jahre Garantie
- Feuerschutz laut DIN 18273
- Getestet auf 1000°C
- Edelstahl Türdrücker festdrehbar OHNE Hochhaltefeder
- Stahl Unterkonstruktion
- Vierkantstift 9 mm
- Höchste Norm: EN1906 Klasse 4



- 10 year guarantee
- Fire rated as per DIN 18273
- Tested at 1000°C
- Lever unsprung
- Steel understructure
- Square spindle 9 mm
- Highest Standard: EN1906 Grade 4



		91050R06.X9
--	--	--------------------

		91050R06.39
--	--	--------------------

		91050R06.U9
--	--	--------------------

Chase 91050

Proline Classic DIN 18273

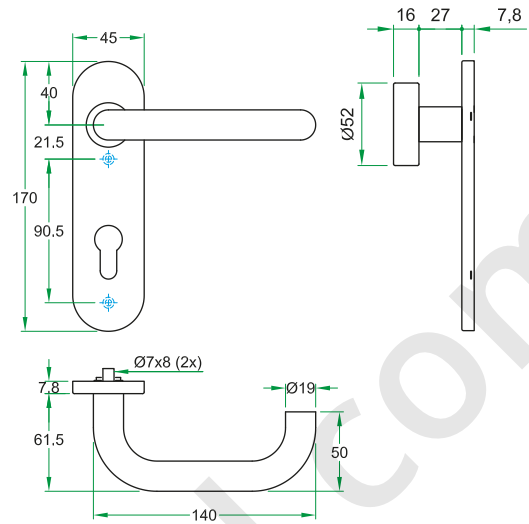

- 10 jaar garantie
- Extra-brandwerend (DIN18273)
- Getest op 1000°C
- RVS deurkruk vastdraaibaar ZONDER veer
- Stalen onderconstructie
- Krukstift 9 mm
- Hoogste norm: EN1906 Klasse 4



- 10 ans de garantie
- Feu extra repoussant (DIN18273)
- Testé à 1000°C
- Béquille fixe SANS ressort
- Sous-construction en acier
- Tige carré 9 mm
- La plus haute norme: EN1906 Classe 4



- 10 Jahre Garantie
- Feuerschutz laut DIN 18273
- Getestet auf 1000°C
- Edelstahl Türdrücker festdrehbar OHNE Hochhaltefeder
- Stahl Unterkonstruktion
- Vierkantstift 9 mm
- Höchste Norm: EN1906 Klasse 4



- 10 year guarantee
- Fire rated as per DIN 18273
- Tested at 1000°C
- Lever UNSprung
- Steel understructure
- Square spindle 9 mm
- Highest Standard: EN1906 Grade 4

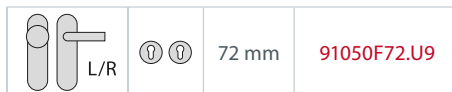
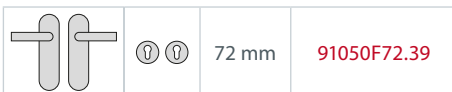

Tessa 91070

Proline Classic DIN 18273



1D

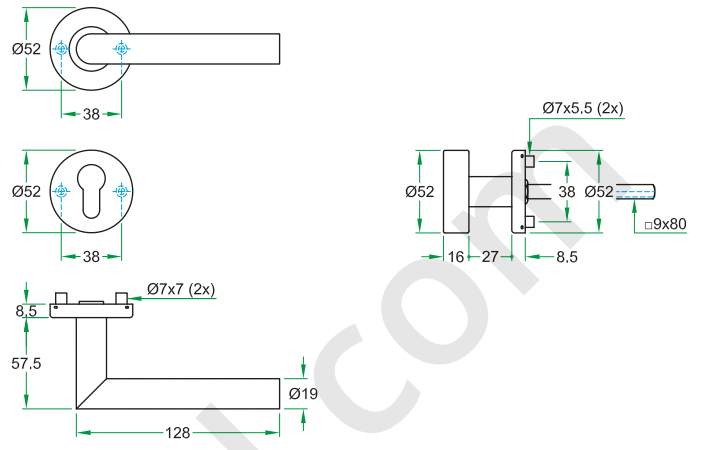

- 10 jaar garantie
- Extra-brandwerend (DIN18273)
- Getest op 1000°C
- RVS deurkruk vastdraaibaar ZONDER veer
- Stalen onderconstructie
- Krukstift 9 mm
- Hoogste norm: EN1906 Klasse 4



- 10 ans de garantie
- Feu extra repoussant (DIN18273)
- Testé à 1000°C
- Béquille fixe SANS ressort
- Sous-construction en acier
- Tige carré 9 mm
- La plus haute norme: EN1906 Classe 4



- 10 Jahre Garantie
- Feuerschutz laut DIN 18273
- Getestet auf 1000°C
- Edelstahl Türdrücker festdrehbar OHNE Hochhaltefeder
- Stahl Unterkonstruktion
- Vierkantstift 9 mm
- Höchste Norm: EN1906 Klasse 4



- 10 year guarantee
- Fire rated as per DIN 18273
- Tested at 1000°C
- Lever unsprung
- Steel understructure
- Square spindle 9 mm
- Highest Standard: EN1906 Grade 4



		91070R06.X9
--	--	-------------

		91070R06.39
--	--	-------------

		91070R06.U9
--	--	-------------

Tessa 91070

Proline Classic DIN 18273

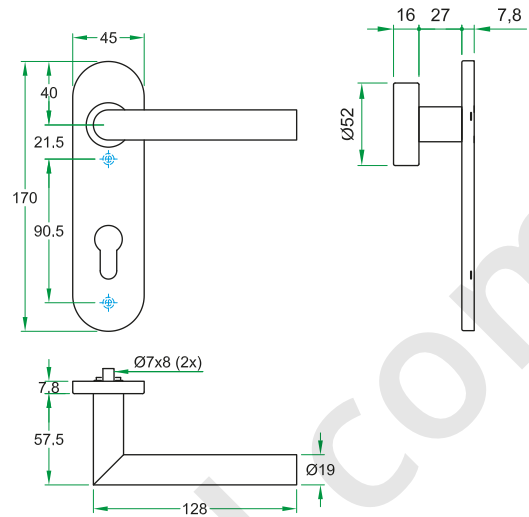
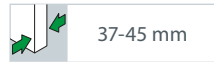

- 10 jaar garantie
- Extra-brandwerend (DIN18273)
- Getest op 1000°C
- RVS deurkruk vastdraaibaar ZONDER veer
- Stalen onderconstructie
- Krukstift 9 mm
- Hoogste norm: EN1906 Klasse 4



- 10 ans de garantie
- Feu extra repoussant (DIN18273)
- Testé à 1000°C
- Béquille fixe SANS ressort
- Sous-construction en acier
- Tige carré 9 mm
- La plus haute norme: EN1906 Classe 4



- 10 Jahre Garantie
- Feuerschutz laut DIN 18273
- Getestet auf 1000°C
- Edelstahl Türdrücker festdrehbar OHNE Hochhaltefeder
- Stahl Unterkonstruktion
- Vierkantstift 9 mm
- Höchste Norm: EN1906 Klasse 4



- 10 year guarantee
- Fire rated as per DIN 18273
- Tested at 1000°C
- Lever UNSprung
- Steel understructure
- Square spindle 9 mm
- Highest Standard: EN1906 Grade 4

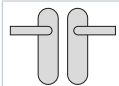

72 mm

91070F72.39

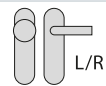

72 mm

91070F72.U9

-   **ONDERDELEN Verlengde stiften en schroeven**
-   **ACCESSOIRES Tiges e vis allongées**
-  **ZUBEHÖR verlängerte Stifte und Schrauben**
-  **PARTS extended spindles and screws**



1D

Excentrische stift
Tige carrée excentrique
Exzentrischer Vkt. Stift
Excentric spindle

□ L

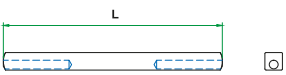
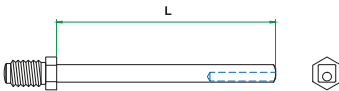

Artikelnr.
Code d'article
Artikelnr.
Article code

		M6				93180*
		□9 mm	✓	110 mm*	max 58 mm	93119*
		□9 mm	✓	130 mm	max 71 mm	93116
		M12/□9 mm	✓	80 mm*	max 60 mm	93124*
		M12/□9 mm	✓	120 mm	max 100 mm	93130
	Rozet/Rosace Rosette/Rose	M4	Staal/Acier Stahl/Steel	50 mm*	36-45 mm	27029*
	Kortschild/Plaque courte Kurzschild/Shortplate	M4	Staal/Acier Stahl/Steel	50 mm*	36-45 mm	27080*
		M4	Staal/Acier Stahl/Steel	60 mm	46-55 mm	27084
		M4	Staal/Acier Stahl/Steel	70 mm	56-65 mm	93234-70
		M4	Staal/Acier Stahl/Steel	80 mm	66-75 mm	93234-80
		M4	Staal/Acier Stahl/Steel	90 mm	76-82 mm	93234-90
		M4	Staal/Acier Stahl/Steel	100 mm	86-95 mm	93234-100
		M4	Staal/Acier Stahl/Steel	120 mm	100 mm	93107

* Standaard meegeleverd in garnituur.

* Fourni standard avec garniture.

* Standard beim Garnitur miteinbegriffen.

* Standard included in each lever set.

XL EN1906-4





Project: ICC
Architect: Schmidt Hammer Lassen



Boda XL **4** 52



Chase XL **4** 53

Boda XL EN91030

XL - EN1906-4



1E

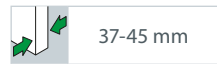
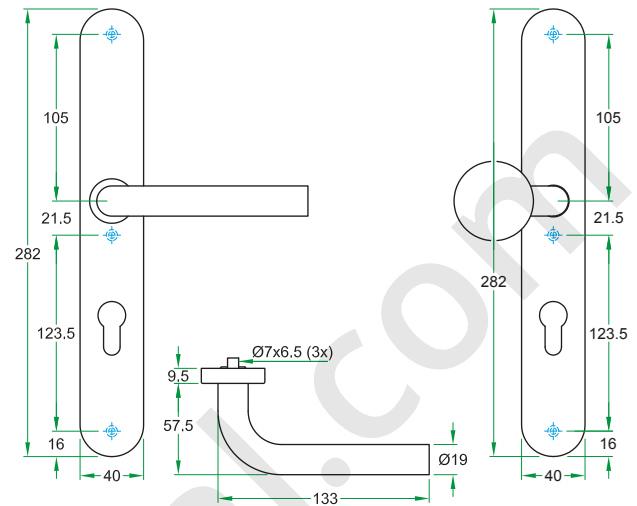
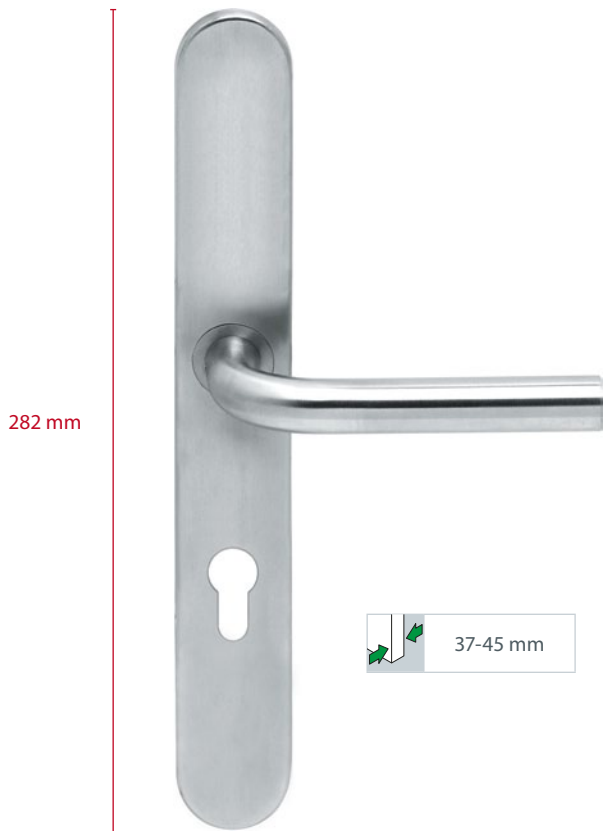

- 10 jaar garantie
- Extra lang schild 282 mm
- Esthetisch combineerbaar met elektronisch beslag
- Hoogste norm: EN1906 Klasse 4
- Brand-/rookwerend (EN1634-2)
- RVS deurkruk vastdraaibaar met veer
- Stalen onderconstructie
- Andere stansmaten mogelijk



- 10 ans de garantie
- Plaque extra longue 282 mm
- A combiner esthétiquement avec garnitures électronique
- La plus haute norme: EN1906 Classe 4
- Feu/fumée repoussante (EN1634-2)
- Béquille fixe avec ressort
- Sous-construction en acier
- Possibilité d'adapter pour différents trous de serrure



- 10 Jahre Garantie
- Extra langes Langschild 282 mm
- Ästhetisch kombinierbar mit elektronischen Beschlägen
- Hochste Norm: EN1906 Klasse 4
- Feuer- & Rauchschutz (EN1634-2)
- Edelstahl Türdrücker festdrehbar mit Hochhaltefeder
- Stahl Unterkonstruktion
- Andere Entfernungen möglich



- 10 year guarantee
- Extra long plate 282 mm
- Combines aesthetically with electronic hardware
- Highest Standard: EN1906 Grade 4
- Fire- & smoke rated (EN1634-2)
- Stainless steel lever sprungloaded
- Steel understructure
- Other key hole options possible.



		-	EN91030C00.58
		72 mm	EN91030C72.38

		72/8 mm	EN91030C72.688
--	--	---------	----------------

L		72 mm	EN91030C72.88
		-	EN91030C00.88
R		72 mm	EN91030C72.98
		-	EN91030C00.98

Chase XL EN91050

XL - EN1906-4



1E

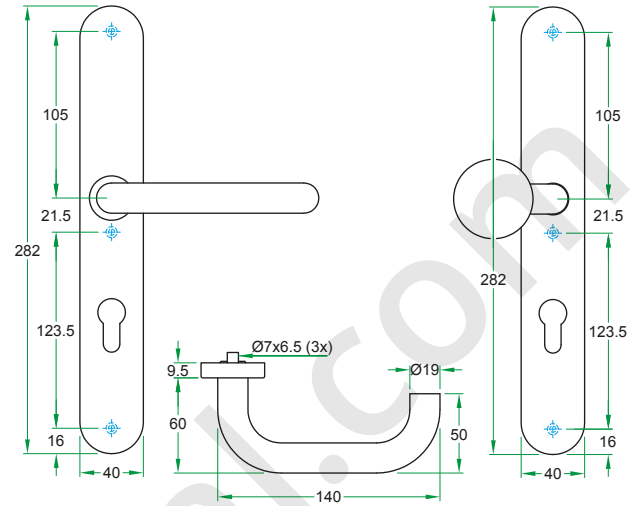
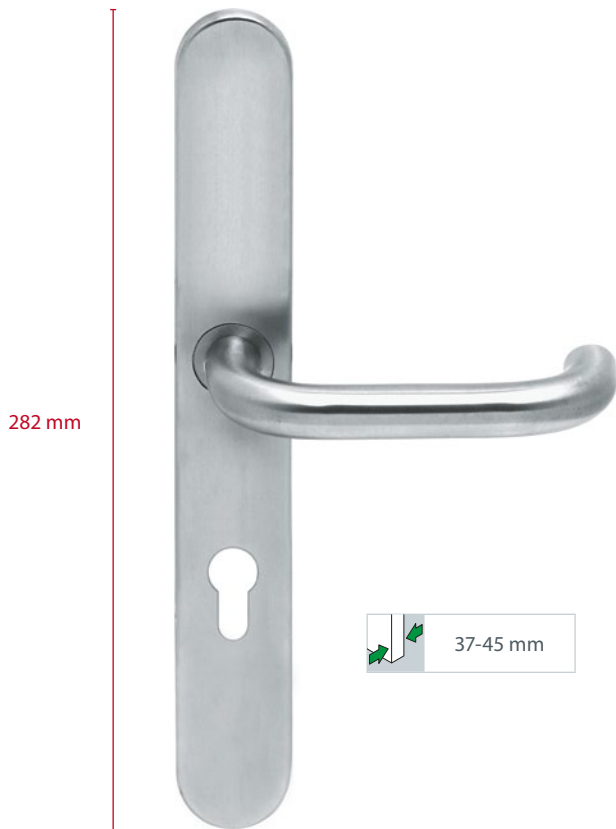

- 10 jaar garantie
- Extra lang schild 282 mm
- Esthetisch combineerbaar met elektronisch beslag
- Hoogste norm: EN1906 Klasse 4
- Brand-/rookwerend (EN1634-2)
- RVS deurkruk vastdraaibaar met veer
- Stalen onderconstructie
- Andere stansmaten mogelijk



- 10 ans de garantie
- Plaque extra longue 282 mm
- A combiner esthétiquement avec garnitures électronique
- La plus haute norme: EN1906 Classe 4
- Feu/fumée repoussante (EN1634-2)
- Béquille fixe avec ressort
- Sous-construction en acier
- Possibilité d'adapter pour différents trous de serrure



- 10 Jahre Garantie
- Extra langes Langschild 282 mm
- Ästhetisch kombinierbar mit elektronischen Beschlagen
- Hochste Norm: EN1906 Klasse 4
- Feuer- & Rauchschutz (EN1634-2)
- Edelstahl Türdrücker festdrehbar mit Hochhaltefeder
- Stahl Unterkonstruktion
- Andere Entfernungen möglich



- 10 year guarantee
- Extra long plate 282 mm
- Combines aesthetically with electronic hardware
- Highest Standard: EN1906 Grade 4
- Fire- & smoke rated (EN1634-2)
- Stainless steel lever sprungloaded
- Steel understructure
- Other key hole options possible.



		-	EN91050C00.58
		72 mm	EN91050C72.38

		72/8 mm	EN91050C72.688
--	--	---------	----------------

		72 mm	EN91050C72.88
		-	EN91050C00.88
		72 mm	EN91050C72.98
		-	EN91050C00.98

COMPONENTEN / COMPOSANTS / ZUBEHÖR / COMPONENTS

Langschilden / Plaques / Schilder / Plates • XL

1E

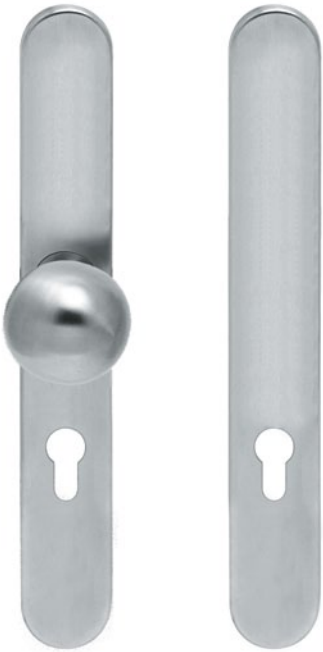

- Meterkastknop XL langschild incl. tegenschild tbv doorgaande bevestiging



- Bouton de compteur plaque XL incl. plaque pour fixation traversant



- Schrankknopf auf Langschild XL einschl. Abdeckschild für durchgehende Befestigung



- Dummy closetknob on longplate XL incl. cover plate for bolt-thru fixing

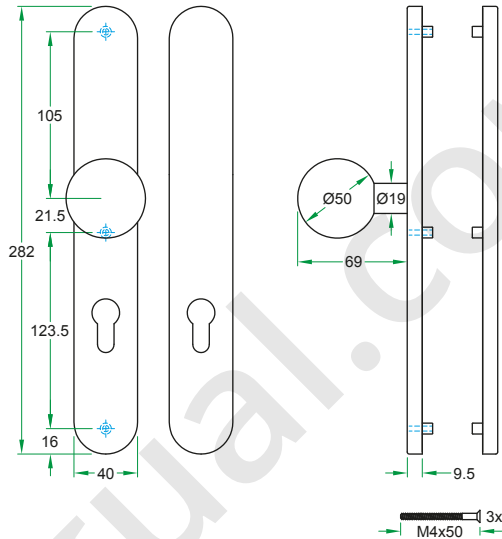

⊕ ⊙	72 mm	97832
⊕ ⊕	72 mm	97833



- Paar deurknop vast op XL-langschild
- Doorgaande bevestiging



- Paire bouton fixe sur plaque XL
- Fixation traversant



- Paar Knöpfe fest auf Langschild XL
- Durchgehende Befestigung



- Pair knob fixed on longplate
- Bolt-thru fixing

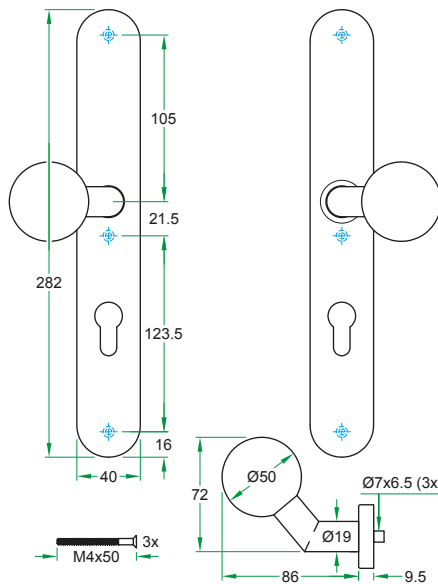

⊙ ⊙	-	97837
⊕ ⊕	72 mm	97838

COMPONENTEN / COMPOSANTS / ZUBEHÖR / COMPONENTS

Langschilden / Plaques / Schilder / Plates • XL



• Afdekschild XL blind



• Plaque XL sans trou



• Abdekschild XL ohne Lochung



• Coverplate XL blind

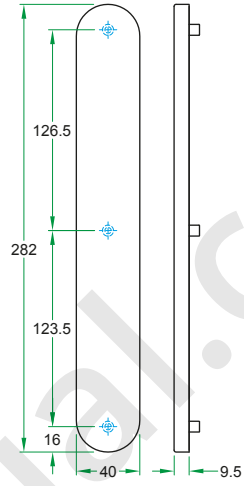

○	-	97835
---	---	-------



• Afdekschild XL PC - 72 mm



• Plaque XL PC - 72 mm



• Abdekschild XL PC - 72 mm



• Coverplate XL PC - 72 mm

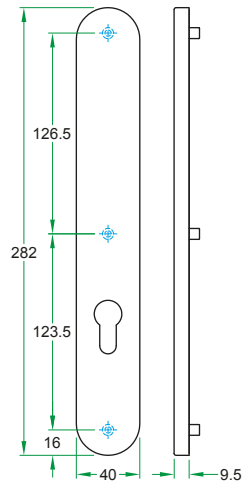

Ⓢ	72 mm	97836
---	-------	-------

-   **ONDERDELEN Verlengde stiften en schroeven**
  **ACCESSOIRES Tiges e vis allongées**
 **ZUBEHÖR verlängerte Stifte und Schrauben**
 **PARTS extended spindles and screws**



1E

Massief 45H staal
Acier 45D massif
Massiv 45H Stahl
Solid 45H Steel

□ L

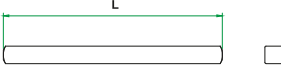
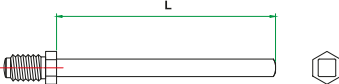

Artikelnr.
Code d'article
Artikelnr.
Article code

	M6				27027*
	□ 8 mm	✓	110 mm*	max 58 mm	93120*
	□ 8 mm	✓	130 mm	max 71 mm	93111
	□ 8 mm	✓	160 mm	max 100 mm	93120-160
	M12/□ 8 mm	✓	80 mm*	max 58 mm	93123*
	M12/□ 8 mm	✓	100 mm	max 71 mm	93127
	M12/□ 8 mm	✓	120 mm	max 91 mm	93129
	M4	Staal/Acier Stahl/Steel	50 mm*	36-45 mm	27029*
	M4	Staal/Acier Stahl/Steel	60 mm	46-55 mm	27084
	M4	Staal/Acier Stahl/Steel	70 mm	56-65 mm	93234-70
	M4	Staal/Acier Stahl/Steel	80 mm	66-75 mm	93234-80
	M4	Staal/Acier Stahl/Steel	90 mm	76-85 mm	93234-90
	M4	Staal/Acier Stahl/Steel	100 mm	86-95 mm	93234-100
	M4	Staal/Acier Stahl/Steel	120 mm	100 mm	93107

* Standaard meegeleverd in garnituur.

* Fourni standard avec garniture.

* Standard beim Garnitur miteinbegriffen.

* Standard included in each lever set.

PERMAFIX proline

EN1906-4 • EN1906-3





Project: The Edge
Architect: PLP Architecture



Bauhaus **4** 60
Bauhaus **3** 61



Cecil **4** 62
Cecil **3** 63



Fabio **4** 64
Fabio **3** 65











Leona **4** 66
Leona **3** 67



Noa **4** 68
Noa **3** 69



Tavira **4** 70
Tavira **3** 71

	Permafix proline	Permafix proline
 Klasse / Classe / Grade	4	3
 		
 EN 1634-2	✓	✓
Garantie / Guarantee		

1F

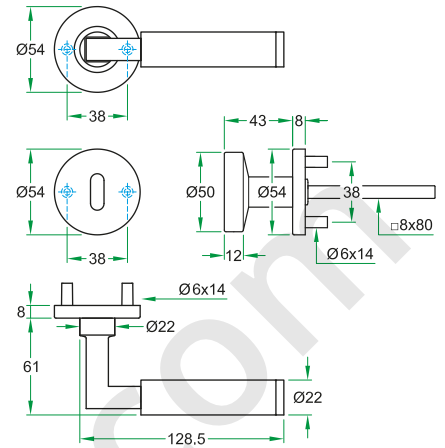

- 10 jaar garantie
- EN1906 klasse 4
- RVS deurkruk vastdraaibaar met dubbelwerkende veer
- Stalen onderconstructie
- Geschikt voor meerpuntsluiting
- Brand-/rookwerend (EN1634-2)



- 10 ans de garantie
- EN1906 classe 4
- Béquille inox avec ressort de retenue à double sens
- Sous-constructie en acier
- Approprié pour serrures multipoints
- Feu/fumée repoussante (EN1634-2)



- 10 Jahre Garantie
- EN1906 Klasse 4
- Edelstahl Türdrücker festdrehbar mit doppeltätigem Hochhaltefeder
- Stahl Unterkonstruktion
- Geeignet für Mehrfachverriegelung
- Feuer- & Rauchschutz (EN1634-2)



- 10 year guarantee
- EN1906 Grade 4
- Stainless steel lever sprungloaded with double working spring
- Steel understructure
- Suitable for multipoint locks
- Fire-smoke rated (EN1634-2)



		91098G02.38
		91098G02.28
		91098G02.58

		8 mm	91098G02.688
--	--	------	--------------

		L/R	91098G02.U8
--	--	-----	-------------

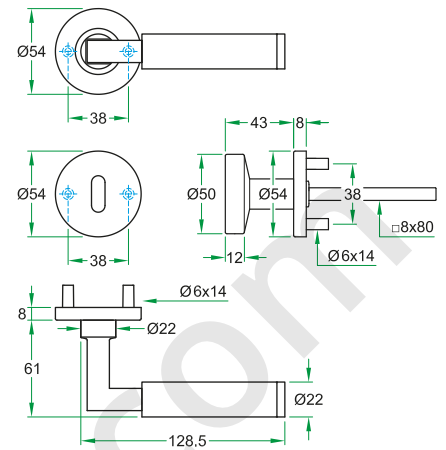

1F

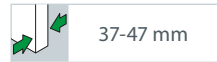

- 5 jaar garantie
- EN1906 klasse 3
- RVS deurkruk vastdraaibaar met dubbelwerkende veer
- Stalen onderconstructie
- Geschikt voor meerpuntsluiting
- Brand-/rookwerend (EN1634-2)



- 5 ans de garantie
- EN1906 classe 3
- Béquille inox avec ressort de retenue à double sens
- Sous-constructie en acier
- Approprié pour serrures multipoints
- Feu/fumée repoussante (EN1634-2)



- 5 Jahre Garantie
- EN1906 Klasse 3
- Edelstahl Türdrücker festdrehbar mit doppeltätigem Hochhaltefeder
- Stahl Unterkonstruktion
- Geeignet für Mehrfachverriegelung
- Feuer- & Rauchschutz (EN1634-2)



- 5 year guarantee
- EN1906 Grade 3
- Stainless steel lever sprungloaded with double working spring
- Steel understructure
- Suitable for multipoint locks
- Fire-smoke rated (EN1634-2)



		91098G01.38
		91098G01.28
		91098G01.58

		8 mm	91098G01.688
--	--	------	--------------

		L/R	91098G02.U8
--	--	-----	-------------

Cecil EN1906-4

PERMAFIX proline



1F

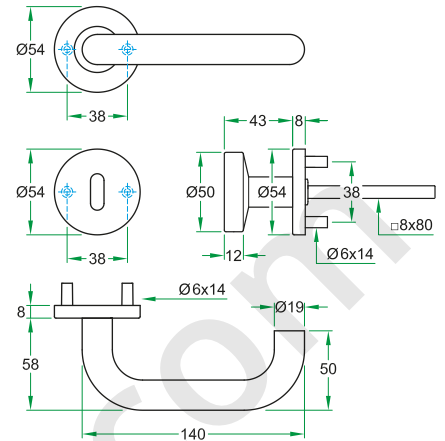

- 10 jaar garantie
- EN1906 klasse 4
- RVS deurkruk vastdraaibaar met dubbelwerkende veer
- Stalen onderconstructie
- Geschikt voor meerpuntsluiting
- Brand-/rookwerend (EN1634-2)



- 10 ans de garantie
- EN1906 classe 4
- Béquille inox avec ressort de retenue à double sens
- Sous-constructie en acier
- Approprié pour serrures multipoints
- Feu/fumée repoussante (EN1634-2)



- 10 Jahre Garantie
- EN1906 Klasse 4
- Edelstahl Türdrücker festdrehbar mit doppeltätigem Hochhaltefeder
- Stahl Unterkonstruktion
- Geeignet für Mehrfachverriegelung
- Feuer- & Rauchschutz (EN1634-2)



- 10 year guarantee
- EN1906 Grade 4
- Stainless steel lever sprungloaded with double working spring
- Steel understructure
- Suitable for multipoint locks
- Fire-smoke rated (EN1634-2)



		91050G02.38
		91050G02.28
		91050G02.58

		8 mm	91050G02.688
--	--	------	--------------

		91050G02.U8
--	--	-------------

Cecil EN1906-3

PERMAFIX proline

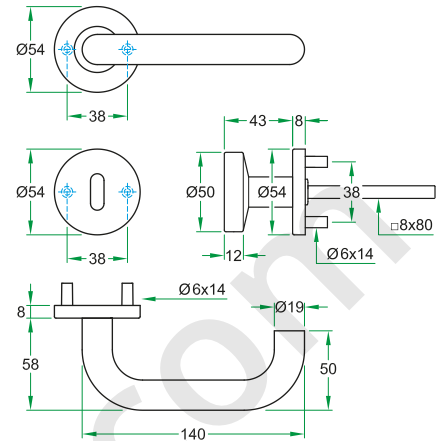

1F



- 5 jaar garantie
- EN1906 klasse 3
- RVS deurkruk vastdraaibaar met dubbelwerkende veer
- Stalen onderconstructie
- Geschikt voor meerpuntsluiting
- Brand-/rookwerend (EN1634-2)



- 5 ans de garantie
- EN1906 classe 3
- Béquille inox avec ressort de retenue à double sens
- Sous-constructie en acier
- Approprié pour serrures multipoints
- Feu/fumée repoussante (EN1634-2)



- 5 Jahre Garantie
- EN1906 Klasse 3
- Edelstahl Türdrücker festdrehbar mit doppeltätigem Hochhaltefeder
- Stahl Unterkonstruktion
- Geeignet für Mehrfachverriegelung
- Feuer- & Rauchschutz (EN1634-2)



- 5 year guarantee
- EN1906 Grade 3
- Stainless steel lever sprungloaded with double working spring
- Steel understructure
- Suitable for multipoint locks
- Fire-smoke rated (EN1634-2)



		91050G01.38
		91050G01.28
		91050G01.58

		8 mm	91050G01.688
--	--	------	--------------

		91050G02.U8
--	--	-------------

Fabio EN1906-4

PERMAFIX proline



1F

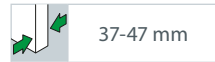
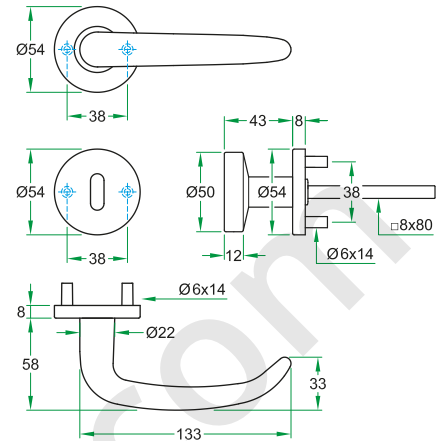

- 10 jaar garantie
- EN1906 klasse 4
- RVS deurkruk vastdraaibaar met dubbelwerkende veer
- Stalen onderconstructie
- Geschikt voor meerpuntsluiting
- Brand-/rookwerend (EN1634-2)



- 10 ans de garantie
- EN1906 classe 4
- Béquille inox avec ressort de retenue à double sens
- Sous-constructie en acier
- Approprié pour serrures multipoints
- Feu/fumée repoussante (EN1634-2)



- 10 Jahre Garantie
- EN1906 Klasse 4
- Edelstahl Türdrücker festdrehbar mit doppeltätigem Hochhaltefeder
- Stahl Unterkonstruktion
- Geeignet für Mehrfachverriegelung
- Feuer- & Rauchschutz (EN1634-2)



- 10 year guarantee
- EN1906 Grade 4
- Stainless steel lever sprungloaded with double working spring
- Steel understructure
- Suitable for multipoint locks
- Fire-smoke rated (EN1634-2)



		91099G02.38
		91099G02.28
		91099G02.58

		8 mm	91099G02.688
--	--	------	--------------

		91099G02.U8
--	--	-------------

Fabio EN1906-3

PERMAFIX proline

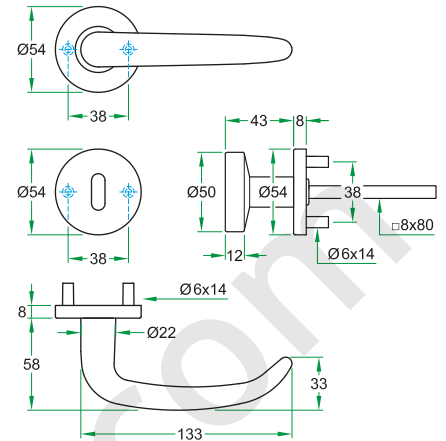

1F



- 5 jaar garantie
- EN1906 klasse 3
- RVS deurkruk vastdraaibaar met dubbelwerkende veer
- Stalen onderconstructie
- Geschikt voor meerpuntsluiting
- Brand-/rookwerend (EN1634-2)



- 5 ans de garantie
- EN1906 classe 3
- Béquille inox avec ressort de retenue à double sens
- Sous-constructie en acier
- Approprié pour serrures multipoints
- Feu/fumée repoussante (EN1634-2)



- 5 Jahre Garantie
- EN1906 Klasse 3
- Edelstahl Türdrücker festdrehbar mit doppeltätigem Hochhaltefeder
- Stahl Unterkonstruktion
- Geeignet für Mehrfachverriegelung
- Feuer- & Rauchschutz (EN1634-2)



- 5 year guarantee
- EN1906 Grade 3
- Stainless steel lever sprungloaded with double working spring
- Steel understructure
- Suitable for multipoint locks
- Fire-smoke rated (EN1634-2)



		91099G01.38
		91099G01.28
		91099G01.58

		8 mm	91099G01.688
--	--	------	--------------

		91099G02.U8
--	--	-------------

Leona EN1906-4

PERMAFIX proline



1F

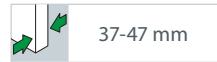
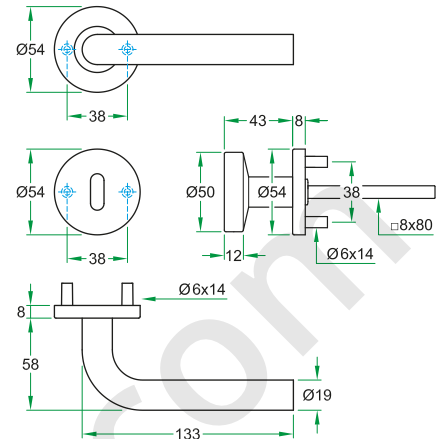

- 10 jaar garantie
- EN1906 klasse 4
- RVS deurkruk vastdraaibaar met dubbelwerkende veer
- Stalen onderconstructie
- Geschikt voor meerpuntsluiting
- Brand-/rookwerend (EN1634-2)



- 10 ans de garantie
- EN1906 classe 4
- Béquille inox avec ressort de retenue à double sens
- Sous-constructie en acier
- Approprié pour serrures multipoints
- Feu/fumée repoussante (EN1634-2)



- 10 Jahre Garantie
- EN1906 Klasse 4
- Edelstahl Türdrücker festdrehbar mit doppeltätigem Hochhaltefeder
- Stahl Unterkonstruktion
- Geeignet für Mehrfachverriegelung
- Feuer- & Rauchschutz (EN1634-2)



- 10 year guarantee
- EN1906 Grade 4
- Stainless steel lever sprungloaded with double working spring
- Steel understructure
- Suitable for multipoint locks
- Fire-smoke rated (EN1634-2)



		91030G02.38
		91030G02.28
		91030G02.58



		8 mm	91030G02.688
--	--	------	--------------



		91030G02.U8
--	--	-------------

Leona EN1906-3

PERMAFIX proline

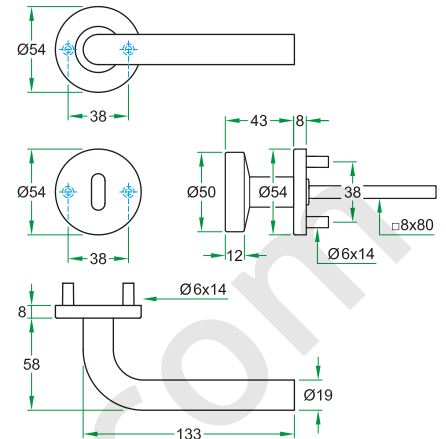

1F

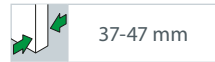

- 5 jaar garantie
- EN1906 klasse 3
- RVS deurkruk vastdraaibaar met dubbelwerkende veer
- Stalen onderconstructie
- Geschikt voor meerpuntsluiting
- Brand-/rookwerend (EN1634-2)



- 5 ans de garantie
- EN1906 classe 3
- Béquille inox avec ressort de retenue à double sens
- Sous-constructie en acier
- Approprié pour serrures multipoints
- Feu/fumée repoussante (EN1634-2)



- 5 Jahre Garantie
- EN1906 Klasse 3
- Edelstahl Türdrücker festdrehbar mit doppeltätigem Hochhaltefeder
- Stahl Unterkonstruktion
- Geeignet für Mehrfachverriegelung
- Feuer- & Rauchschutz (EN1634-2)



- 5 year guarantee
- EN1906 Grade 3
- Stainless steel lever sprungloaded with double working spring
- Steel understructure
- Suitable for multipoint locks
- Fire-smoke rated (EN1634-2)



		91030G01.38
		91030G01.28
		91030G01.58

		8 mm	91030G01.688
--	--	------	--------------

		91030G02.U8
--	--	-------------

Noa EN1906-4

PERMAFIX proline



1F

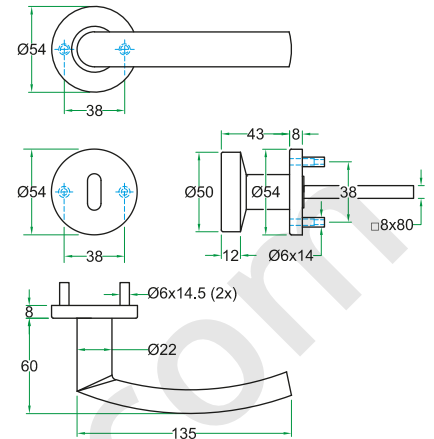

- 10 jaar garantie
- EN1906 klasse 4
- RVS deurkruk vastdraaibaar met dubbelwerkende veer
- Stalen onderconstructie
- Geschikt voor meerpuntsluiting
- Brand-/rookwerend (EN1634-2)



- 10 ans de garantie
- EN1906 classe 4
- Béquille inox avec ressort de retenue à double sens
- Sous-constructie en acier
- Approprié pour serrures multipoints
- Feu/fumée repoussante (EN1634-2)



- 10 Jahre Garantie
- EN1906 Klasse 4
- Edelstahl Türdrücker festdrehbar mit doppeltätigem Hochhaltefeder
- Stahl Unterkonstruktion
- Geeignet für Mehrfachverriegelung
- Feuer- & Rauchschutz (EN1634-2)



- 10 year guarantee
- EN1906 Grade 4
- Stainless steel lever sprungloaded with double working spring
- Steel understructure
- Suitable for multipoint locks
- Fire-smoke rated (EN1634-2)



		91023G02.38
		91023G02.28
		91023G02.58

		8 mm	91023G02.688
--	--	------	--------------

		91023G02.U8
--	--	-------------

Noa EN1906-3

PERMAFIX proline

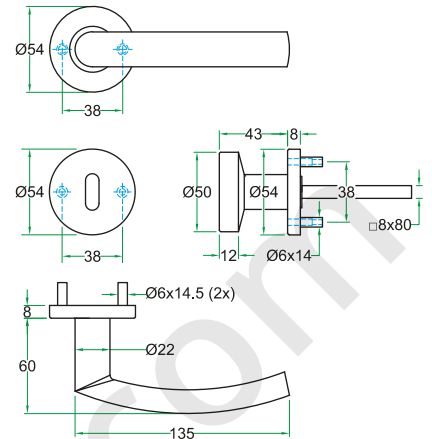

1F

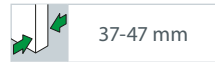

- 5 jaar garantie
- EN1906 klasse 3
- RVS deurkruk vastdraaibaar met dubbelwerkende veer
- Stalen onderconstructie
- Geschikt voor meerpuntsluiting
- Brand-/rookwerend (EN1634-2)



- 5 ans de garantie
- EN1906 classe 3
- Béquille inox avec ressort de retenue à double sens
- Sous-constructie en acier
- Approprié pour serrures multipoints
- Feu/fumée repoussante (EN1634-2)



- 5 Jahre Garantie
- EN1906 Klasse 3
- Edelstahl Türdrücker festdrehbar mit doppeltätigem Hochhaltefeder
- Stahl Unterkonstruktion
- Geeignet für Mehrfachverriegelung
- Feuer- & Rauchschutz (EN1634-2)



- 5 year guarantee
- EN1906 Grade 3
- Stainless steel lever sprungloaded with double working spring
- Steel understructure
- Suitable for multipoint locks
- Fire-smoke rated (EN1634-2)



		91023G01.38
		91023G01.28
		91023G01.58

		8 mm	91023G01.688
--	--	------	--------------

		91023G02.U8
--	--	-------------

Tavira EN1906-4

PERMAFIX proline



1F

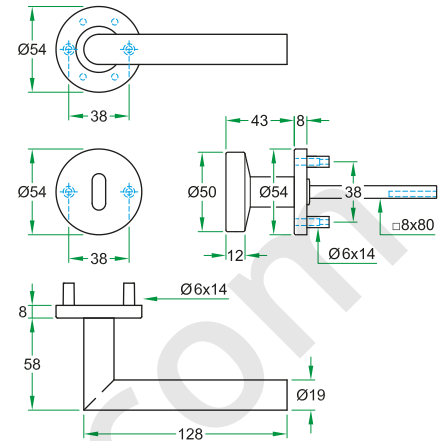

- 10 jaar garantie
- EN1906 klasse 4
- RVS deurkruk vastdraaibaar met dubbelwerkende veer
- Stalen onderconstructie
- Geschikt voor meerpuntsluiting
- Brand-/rookwerend (EN1634-2)



- 10 ans de garantie
- EN1906 classe 4
- Béquille inox avec ressort de retenue à double sens
- Sous-constructie en acier
- Approprié pour serrures multipoints
- Feu/fumée repoussante (EN1634-2)



- 10 Jahre Garantie
- EN1906 Klasse 4
- Edelstahl Türdrücker festdrehbar mit doppeltätigem Hochhaltefeder
- Stahl Unterkonstruktion
- Geeignet für Mehrfachverriegelung
- Feuer- & Rauchschutz (EN1634-2)



- 10 year guarantee
- EN1906 Grade 4
- Stainless steel lever sprungloaded with double working spring
- Steel understructure
- Suitable for multipoint locks
- Fire-smoke rated (EN1634-2)



		91070G02.38
		91070G02.28
		91070G02.58

		8 mm	91070G02.688
--	--	------	--------------

		91070G02.U8
--	--	-------------

Tavira EN1906-3

PERMAFIX proline

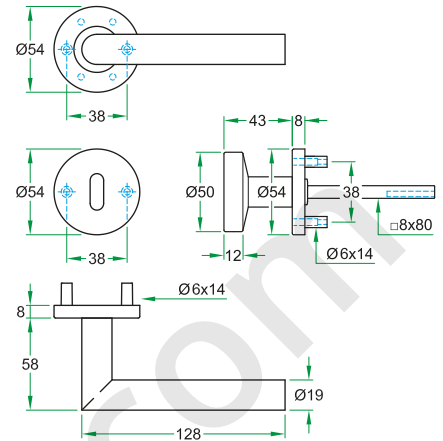

1F



- 5 jaar garantie
- EN1906 klasse 3
- RVS deurkruk vastdraaibaar met dubbelwerkende veer
- Stalen onderconstructie
- Geschikt voor meerpuntsluiting
- Brand-/rookwerend (EN1634-2)



- 5 ans de garantie
- EN1906 classe 3
- Béquille inox avec ressort de retenue à double sens
- Sous-constructie en acier
- Approprié pour serrures multipoints
- Feu/fumée repoussante (EN1634-2)



- 5 Jahre Garantie
- EN1906 Klasse 3
- Edelstahl Türdrücker festdrehbar mit doppeltätigem Hochhaltefeder
- Stahl Unterkonstruktion
- Geeignet für Mehrfachverriegelung
- Feuer- & Rauchschutz (EN1634-2)



- 5 year guarantee
- EN1906 Grade 3
- Stainless steel lever sprungloaded with double working spring
- Steel understructure
- Suitable for multipoint locks
- Fire-smoke rated (EN1634-2)



		91070G01.38
		91070G01.28
		91070G01.58

		8 mm	91070G01.688
--	--	------	--------------

		91070G02.U8
--	--	-------------

COMPONENTEN / COMPOSANTS / ZUBEHÖR / COMPONENTS

Rozet / Rosace / Rosette / Rose • PERMAFIX

1F

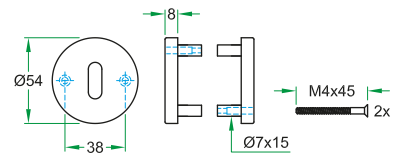

⊕ ⊕	27225	⊕ ⊕	27224	⊙ ⊙	27228
-----	-------	-----	-------	-----	-------

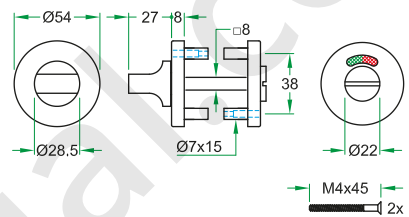

⊕ ⊕	8 mm	27227
-----	------	-------

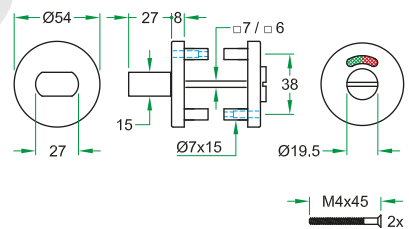

⊕ ⊕	6/7 mm	27221
-----	--------	-------



⊕ ⊕	93600
-----	-------



- Specifiek ontworpen voor Permafix deurbeslag
- Kunststof beschermring bij montage op glasdeur



- Dessiné exclusivement pour les béquilles Permafix
- Anneau de protection en nylon pour le montage sur la porte en verre



- Spezifisch entworfen für Permafix Türbeschläge
- Kunststoff Schutzzeinsatz bei Montage auf Glasstür



- Designed exclusively for Permafix door levers
- Nylon inlay as buffer for fixing on glass door

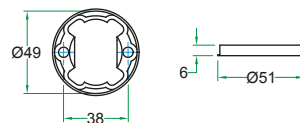

COMPONENTEN / COMPOSANTS / ZUBEHÖR / COMPONENTS

Knoppen / Boutons / Knöpfe / Knobs • PERMAFIX

1F



- Draaibare knop met veer op rozet zonder nokken
- Knopgat \square 8 mm
- Wordt zonder stift geleverd



- Bouton tournant avec ressort sur rosace sans cames
- Trou de bouton \square 8 mm
- Fourni sans tige carrée



- Drehbarer Knopf mit Hochhaltefeder auf Rosette ohne Nocken
- Vierkantloch \square 8 mm
- Vierkantstift nicht mit inbegriffen



- Turnable knob sprungloaded on rose without lugs
- Square hole \square 8 mm
- Spindle not included

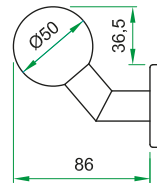
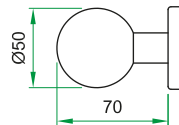

- Wisselknop op rozet
- Wisselstift met schroefdraad 6 mm
- Heso 8 x 80 mm
- Ook als MK-knop te gebruiken in combi met 27228



- Bouton fixe sur rosace
- Tige carrée filetage 6 mm
- Tige heso 8 x 80 mm



- Wechselknopf auf Rosette
- We-stift mit Schraubgewinde M6
- Vkt. Stift 8 x 80 mm exzentrisch gebohrt



- Knob fixed on rose
- Knob spindle with thread 6 mm
- Spindle 8 x 80 mm w/excentric hole

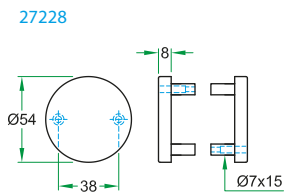
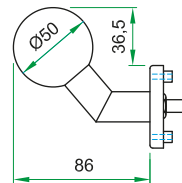
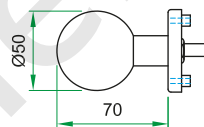

- Knop vast op rozet zonder nokken
- Knopgat \square 8 mm
- Wordt zonder stift geleverd



- Bouton fixe sur rosace sans cames
- Trou de bouton \square 8 mm
- Fourni sans tige carrée



- Knopf fest auf Rosette ohne Nocken
- Vierkantloch \square 8 mm
- Vierkantstift nicht mit inbegriffen



- Knob fixed on rose without lugs
- Square hole \square 8 mm
- Spindle not included

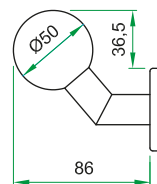
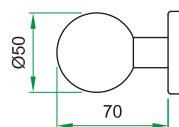

COMPONENTEN / COMPOSANTS / ZUBEHÖR / COMPONENTS

Knoppen / Boutons / Knöpfe / Knobs • PERMAFIX

1F



- Paar knoppen vast op rozet zonder nokken
- Knopgat \square 8 mm
- Incl. krukstift 8x110 mm



- Paire bouton fixe sur rosace sans cames
- Trou de bouton \square 8 mm
- Incl. tige carrée 8 x 110 mm



- Paar Knöpfe fest auf Rosette ohne Nocken
- Vierkantloch \square 8 mm
- Einschl. Vierkantstift 8 x 110 mm



- Knob fixed on rose without lugs
- Square hole \square 8 mm
- Spindle included 8 x 110 mm

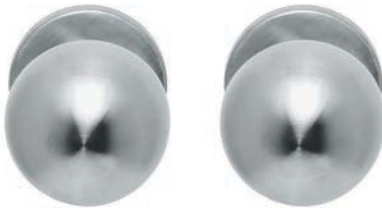
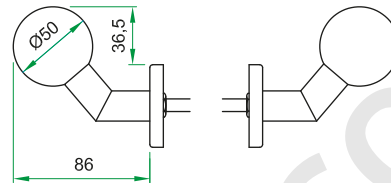

- Paar knoppen vast op rozet zonder nokken
- Knopgat \square 8 mm
- Incl. krukstift 8x110 mm



- Paire bouton fixe sur rosace sans cames
- Trou de bouton \square 8 mm
- Incl. tige carrée 8 x 110 mm



- Paar Knöpfe fest auf Rosette ohne Nocken
- Vierkantloch \square 8 mm
- Einschl. Vierkantstift 8 x 110 mm



- Knob fixed on rose without lugs
- Square hole \square 8 mm
- Spindle included 8 x 110 mm

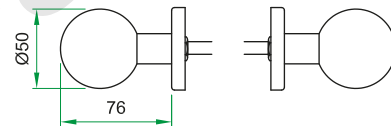

PERMAFIX proline EN1906-4

-   **ONDERDELEN** Verlengde stiften en schroeven
-   **ACCESSOIRES** Tiges e vis allongées
-  **ZUBEHÖR** verlängerte Stifte und Schrauben
-  **PARTS** extended spindles and screws





Massief 45H staal
Acier 45D massif
Massiv 45H Stahl
Solid 45H Steel

□ L

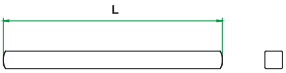
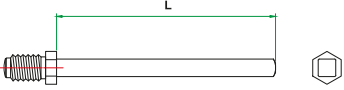

Artikelnr.
Code d'article
Artikelnr.
Article code

1F

		M6				27027*
		□ 8 mm	✓	110 mm*	max 58 mm	93120*
		□ 8 mm	✓	130 mm	max 71 mm	93111
		□ 8 mm	✓	160 mm	max 100 mm	93120-160
		M12/□ 8 mm	✓	80 mm*	max 58 mm	93123*
		M12/□ 8 mm	✓	100 mm	max 71 mm	93127
		M12/□ 8 mm	✓	120 mm	max 91 mm	93129
		M4	Staal/Acier Stahl/Steel	50 mm*	36-45 mm	27029*
		M4	Staal/Acier Stahl/Steel	60 mm	46-55 mm	27084
		M4	Staal/Acier Stahl/Steel	70 mm	56-65 mm	93234-70
		M4	Staal/Acier Stahl/Steel	80 mm	66-75 mm	93234-80
		M4	Staal/Acier Stahl/Steel	90 mm	76-85 mm	93234-90
		M4	Staal/Acier Stahl/Steel	100 mm	86-95 mm	93234-100
		M4	Staal/Acier Stahl/Steel	120 mm	100 mm	93107
	Kunststof/Nylon Kunststoff/Nylon					93600

- * Standaard meegeleverd in garnituur.
- * Fourni standard avec garniture.
- * Standard beim Garnitur miteinbegriffen.
- * Standard included in each lever set.

PERMAFIX proline EN1906-3

-   **ONDERDELEN** Verlengde stiften en schroeven
-   **ACCESSOIRES** Tiges e vis allongées
-  **ZUBEHÖR** verlängerte Stifte und Schrauben
-  **PARTS** extended spindles and screws





1F

Excentrische stift
Tige carrée excentrique
Exzentrischer Vkt. Stift
Excentric spindle

□ L

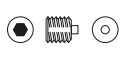
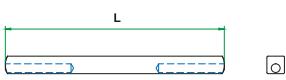
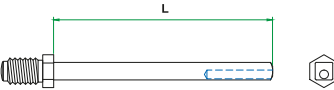

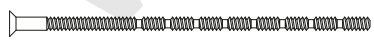
Artikelnr.
Code d'article
Artikelnr.
Article code

		M6				93180*
		□ 8 mm	✓	110 mm*	max 58 mm	93156*
		□ 8 mm	✓	130 mm	max 71 mm	93202
		□ 8 mm	✓	155 mm	max 96 mm	97717
		□ 8 mm	✓	160 mm	max 100 mm	93109
		M12/□ 8 mm	✓	80 mm*	max 58 mm	93142*
		M12/□ 8 mm	✓	89 mm	max 67 mm	93130
		M12/□ 8 mm	✓	99 mm	max 77 mm	93145
		M12/□ 8 mm	✓	125 mm	max 102 mm	97118
		M4	Staal/Acier Stahl/Steel	50 mm*	36-45 mm	27029*
		M4	Staal/Acier Stahl/Steel	60 mm	46-55 mm	27084
		M4	Staal/Acier Stahl/Steel	70 mm	56-65 mm	93234-70
		M4	Staal/Acier Stahl/Steel	80 mm	66-75 mm	93234-80
		M4	Staal/Acier Stahl/Steel	90 mm	76-82 mm	93234-90
		M4	Staal/Acier Stahl/Steel	100 mm	86-95 mm	93234-100
		M4	Staal/Acier Stahl/Steel	120 mm	100 mm	93107
	Kunststof/Nylon Kunststoff/Nylon					93600

- * Standaard meegeleverd in garnituur.
- * Fourni standard avec garniture.
- * Standard beim Garnitur miteinbegriffen.
- * Standard included in each lever set.

Slimface





Project: New Orleans
Architect: Alvaro Siza



Boda Ø 16 mm 80

Tessa Ø 16 mm 81

www.mengual.com

Componenten / Composants / Zubehör / Components 82

Boda 16 mm

Slimface

10
GUARANTEE

1G

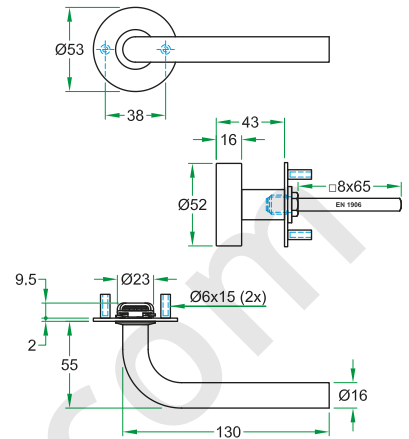

0101002-X



37-45 mm



- 10 jaar garantie
- 2 mm rvs vlakrozet MET dubbel werkende veer
- RVS deurkruk vastdraaibaar
- Eenzijdig onzichtbare schroefbevestiging
- Geschikt voor stompe deuren



- 10 ans de garantie
- Rosace 2 mm en inox AVEC ressort de retenue à double sens
- Béquille inox fixe sur rosace
- Fixation visible unilatérale
- Approprié pour portes à chants plats



- 10 Jahre Garantie
- 2 mm Edelstahl Flachrosette MIT doppeltätigen Hochhaltefeder
- Edelstahl Türdrücker festdrehbar
- Einseitige verdeckte Verschraubung
- Geeignet für stumpfe Türen



- 10 year guarantee
- 2 mm stainless steel flat rose WITH double working spring
- Stainless steel lever
- Invisible screw fixing on 1 side
- Suitable for flush doors

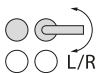

0101002-3U

Tessa 16 mm

Slimface

10
GUARANTEE

1G

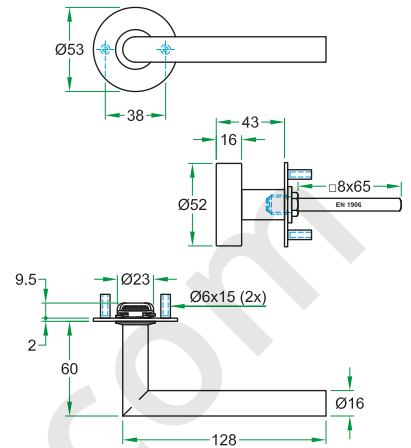

- 10 jaar garantie
- 2 mm rvs vlakrozet MET dubbel werkende veer
- RVS deurkruk vastdraaibaar
- Eenzijdig onzichtbare schroefbevestiging
- Geschikt voor stompe deuren



- 10 ans de garantie
- Rosace 2 mm en inox AVEC ressort de retenue à double sens
- Béquille inox fixe sur rosace
- Fixation visible unilatérale
- Approprié pour portes à chants plats



- 10 Jahre Garantie
- 2 mm Edelstahl Flachrosette MIT doppeltätigen Hochhaltefeder
- Edelstahl Türdrücker festdrehbar
- Einseitige verdeckte Verschraubung
- Geeignet für stumpfe Türen



- 10 year guarantee
- 2 mm stainless steel flat rose WITH double working spring
- Stainless steel lever
- Invisible screw fixing on 1 side
- Suitable for flush doors



COMPONENTEN / COMPOSANTS / ZUBEHÖR / COMPONENTS

Knoppen / Boutons / Knöpfe / Knobs • Slimface

1G



- Meterkastknop vast op rozet incl. tegenrozet t.b.v. doorgaande bevestiging



- Bouton de compteur fixe sur rosace incl. rosace pour fixation traversant



- Schrankknopf fest auf Rosette einschl. Abdeckrosette für durchgehende Befestigung



- Dummy closetknob fixed on rose incl. cover rose for bolt-thru fixing

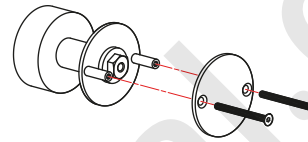
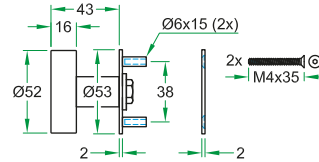

98009



- Paar deurknop vast op rozet
- Doorgaande bevestiging



- Paire bouton fixe sur rosace
- Fixation traversant



- Paar Knöpfe fest auf Rosette
- Durchgehende Befestigung



- Pair knob fixed on rose
- Bolt-thru fixing

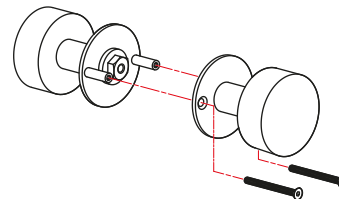
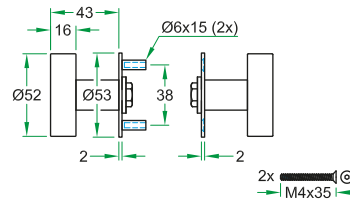

98010

COMPONENTEN / COMPOSANTS / ZUBEHÖR / COMPONENTS

Rozet / Rosace / Rosette / Rose • Slimface



① ① 98002

① ① 98001

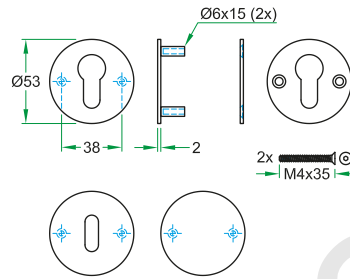

○ ○ 98004



① ② 98005

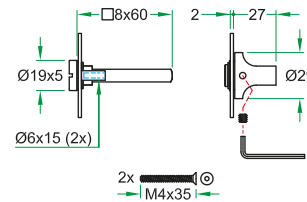
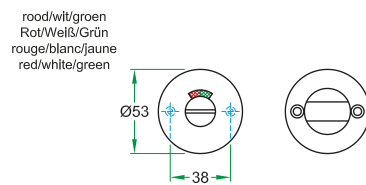

-   **ONDERDELEN Verlengde stiften en schroeven**
  **ACCESSOIRES Tiges e vis allongées**
 **ZUBEHÖR verlängerte Stifte und Schrauben**
 **PARTS extended spindles and screws**

1G

Massief 45H staal
Acier 45D massif
Massiv 45H Stahl
Solid 45H Steel

□L



Artikelnr.
Code d'article
Artikelnr.
Article code

	M5x4 (Ø16 mm)				27031
	□8 mm	✓	110 mm*	max 70 mm	93120*
	□8 mm	✓	130 mm	max 90 mm	93111
	M12/□8 mm	✓	65 mm*	max 58 mm	
	M12/□8 mm	✓	80 mm	max 73 mm	93123
	M4	RVS/Inox Edelstahl/Stainless steel	35 mm*	36-45 mm	
	M4	RVS/Inox Edelstahl/Stainless steel	50 mm	52-58 mm	93239-50

* Standaard meegeleverd in garnituur.

* Fourni standard avec garniture.

* Standard beim Garnitur miteingegriffen.

* Standard included in each lever set.

Profieldeurbeslag

Quincaillerie de porte à chassis profil

Schmalrahmen

Profile door hardware





Project: Rijnstraat 8
Architect: Ector Hoogstad Architecten



Boda **4** 88



Chase **4** 89

Chase 9 mm **4** 89



Chase II **4** 90

Chase II 9 mm **4** 90



Cindy **4** 91

Cindy 9 mm **4** 91



Tessa **4** 92

Tessa 9 mm **4** 92



Tessa II **4** 93

Tessa II 9 mm **4** 93



Tessa Detour **4** 94

Tessa Detour 9 mm **4** 94



Rondo **4** 95

Rondo 9 mm **4** 95

Boda

Profieldeurbeslag / Quincaillerie de porte à chassis profil / Schmalrahmen / Profile door hardware

10
GARANTIE

EN 1906
4

1H

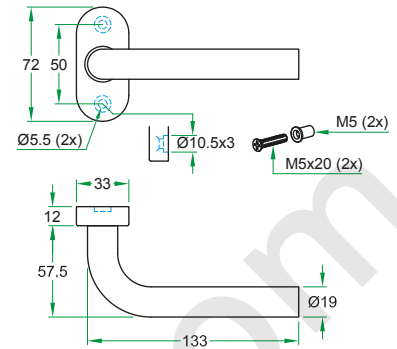

- 10 jaar garantie
- Hoogste norm: EN1906 klasse 4
- RVS deurkruk vastdraaibaar met veer
- Stalen onderconstructie gevuld met kunststof
- Geschikt voor sloten met meerpuntsluiting
- Stift separaat bestellen



- 10 ans de garantie
- La plus haute norme: EN1906 Classe 4
- Béquille fixe avec ressort de retenu
- Sous-construction en acier montée sur une embase en nylon
- Approprié pour serrures multipoints
- Tige carrée à commander séparément



- 10 Jahre Garantie
- Höchste Norm: EN1906 Klasse 4
- Edelstahl Türdrücker festdrehbar mit Hochhaltefeder
- Stahl Unterkonstruktion gefüllt mit Kunststoff
- Geeignet für Mehrfachschlösser Vierkantstift separat bestellen



- 10 year guarantee
- Highest standard: EN1906 Grade 4
- Stainless steel lever sprungloaded
- Steel understructure filled with nylon
- Suitable for multipoint locks
- Order square spindle separately

EN 1906
4



	8 mm	91393R07.X8*
---	------	--------------

- * Met veer
- * Avec ressort
- * Mit Hochhaltefeder.
- * Sprungloaded

Chase

Profieldeurbeslag / Quincaillerie de porte à chassis profil / Schmalrahmen / Profile door hardware

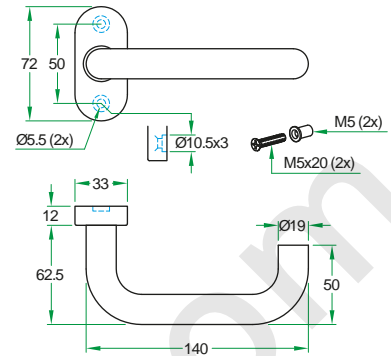

1H



- 10 jaar garantie
- Hoogste norm: EN1906 klasse 4
- RVS deurkruk vastdraaibaar met veer
- Stalen onderconstructie gevuld met kunststof
- Geschikt voor sloten met meerpuntsluiting
- Stift separaat bestellen



- 10 ans de garantie
- La plus haute norme: EN1906 Classe 4
- Béquille fixe avec ressort de retenu
- Sous-structure en acier montée sur une embase en nylon
- Approprié pour serrures multipoints
- Tige carrée à commander séparément



- 10 Jahre Garantie
- Höchste Norm: EN1906 Klasse 4
- Edelstahl Türdrücker festdrehbar mit Hochhaltefeder
- Stahl Unterkonstruktion gefüllt mit Kunststoff
- Geeignet für Mehrfachschlösser Vierkantstift separat bestellen



- 10 year guarantee
- Highest standard: EN1906 Grade 4
- Stainless steel lever sprungloaded
- Steel understructure filled with nylon
- Suitable for multipoint locks
- Order square spindle separately



	8 mm	91435R07.X8*
--	------	--------------

- * Met veer
- * Avec ressort
- * Mit Hochhaltefeder
- * Sprungloaded



	9 mm	91435R07.X9*
--	------	--------------

- * Zonder veer
- * Sans ressort
- * Ohne Hochhaltefeder
- * Unsprung

Chase II

Profieldeurbeslag / Quincaillerie de porte à chassis profil / Schmalrahmen / Profile door hardware



1H

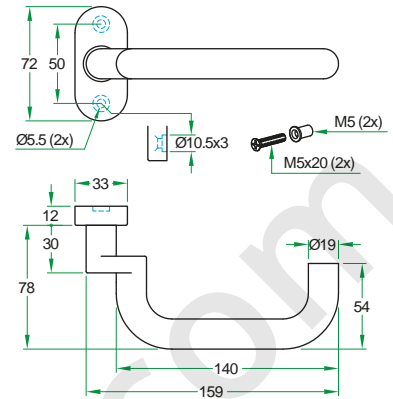

- 10 jaar garantie
- Hoogste norm: EN1906 klasse 4
- RVS deurkruk vastdraaibaar met veer
- Stalen onderconstructie gevuld met kunststof
- Geschikt voor sloten met meerpuntsluiting
- Stift separaat bestellen



- 10 ans de garantie
- La plus haute norme: EN1906 Classe 4
- Béquille fixe avec ressort de retenu
- Sous-construction en acier montée sur une embase en nylon
- Approprié pour serrures multipoints
- Tige carrée à commander séparément



- 10 Jahre Garantie
- Höchste Norm: EN1906 Klasse 4
- Edelstahl Türdrücker festdrehbar mit Hochhaltefeder
- Stahl Unterkonstruktion gefüllt mit Kunststoff
- Geeignet für Mehrfachschlösser Vierkantstift separat bestellen



- 10 year guarantee
- Highest standard: EN1906 Grade 4
- Stainless steel lever sprungloaded
- Steel understructure filled with nylon
- Suitable for multipoint locks
- Order square spindle separately



	8 mm	91431R07.X8*
--	------	--------------

- * Met veer
- * Avec ressort
- * Mit Hochhaltefeder
- * Sprungloaded

	9 mm	91431R07.X9*
--	------	--------------

- * Zonder veer
- * Sans ressort
- * Ohne Hochhaltefeder
- * Unsprung

Cindy

Profieldeurbeslag / Quincaillerie de porte à chassis profil / Schmalrahmen / Profile door hardware

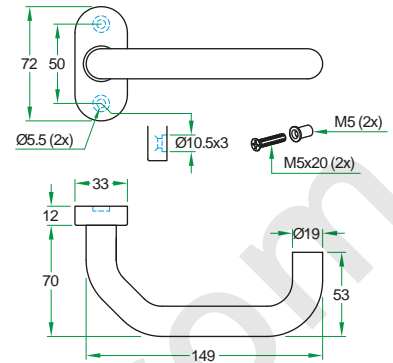

1H



- 10 jaar garantie
- Hoogste norm: EN1906 klasse 4
- RVS deurkruk vastdraaibaar met veer
- Stalen onderconstructie gevuld met kunststof
- Geschikt voor sloten met meerpuntsluiting
- Stift separaat bestellen



- 10 ans de garantie
- La plus haute norme: EN1906 Classe 4
- Béquille fixe avec ressort de retenu
- Sous-construction en acier montée sur une embase en nylon
- Approprié pour serrures multipoints
- Tige carrée à commander séparément



- 10 Jahre Garantie
- Höchste Norm: EN1906 Klasse 4
- Edelstahl Türdrücker festdrehbar mit Hochhaltefeder
- Stahl Unterkonstruktion gefüllt mit Kunststoff
- Geeignet für Mehrfachschlösser Vierkantstift separat bestellen



- 10 year guarantee
- Highest standard: EN1906 Grade 4
- Stainless steel lever sprungloaded
- Steel understructure filled with nylon
- Suitable for multipoint locks
- Order square spindle separately



	8 mm	91411R07.X8*
--	------	--------------

- * Met veer
- * Avec ressort
- * Mit Hochhaltefeder
- * Sprungloaded

	9 mm	91411R07.X9*
--	------	--------------

- * Zonder veer
- * Sans ressort
- * Ohne Hochhaltefeder
- * Unsprung

1H

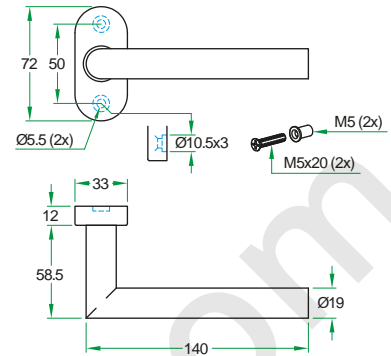

- 10 jaar garantie
- Hoogste norm: EN1906 klasse 4
- RVS deurkruk vastdraaibaar met veer
- Stalen onderconstructie gevuld met kunststof
- Geschikt voor sloten met meerpuntsluiting
- Stift separaat bestellen



- 10 ans de garantie
- La plus haute norme: EN1906 Classe 4
- Béquille fixe avec ressort de retenu
- Sous-construction en acier montée sur une embase en nylon
- Approprié pour serrures multipoints
- Tige carrée à commander séparément



- 10 Jahre Garantie
- Höchste Norm: EN1906 Klasse 4
- Edelstahl Türdrücker festdrehbar mit Hochhaltefeder
- Stahl Unterkonstruktion gefüllt mit Kunststoff
- Geeignet für Mehrfachschlößer Vierkantstift separat bestellen



- 10 year guarantee
- Highest standard: EN1906 Grade 4
- Stainless steel lever sprungloaded
- Steel understructure filled with nylon
- Suitable for multipoint locks
- Order square spindle separately

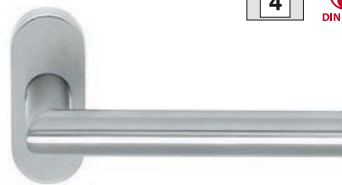

	8 mm	91455R07.X8*
--	------	--------------

- * Met veer
- * Avec ressort
- * Mit Hochhaltefeder
- * Sprungloaded

	9 mm	91455R07.X9*
--	------	--------------

- * Zonder veer
- * Sans ressort
- * Ohne Hochhaltefeder
- * Unsprung

Tessa II

Profieldeurbeslag / Quincaillerie de porte à chassis profil / Schmalrahmen / Profile door hardware

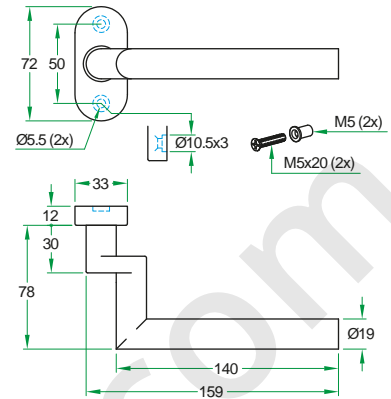

1H



- 10 jaar garantie
- Hoogste norm: EN1906 klasse 4
- RVS deurkruk vastdraaibaar met veer
- Stalen onderconstructie gevuld met kunststof
- Geschikt voor sloten met meerpuntsluiting
- Stift separaat bestellen



- 10 ans de garantie
- La plus haute norme: EN1906 Classe 4
- Béquille fixe avec ressort de retenu
- Sous-construction en acier montée sur une embase en nylon
- Approprié pour serrures multipoints
- Tige carrée à commander séparément



- 10 Jahre Garantie
- Höchste Norm: EN1906 Klasse 4
- Edelstahl Türdrücker festdrehbar mit Hochhaltefeder
- Stahl Unterkonstruktion gefüllt mit Kunststoff
- Geeignet für Mehrfachschlösser Vierkantstift separat bestellen



- 10 year guarantee
- Highest standard: EN1906 Grade 4
- Stainless steel lever sprungloaded
- Steel understructure filled with nylon
- Suitable for multipoint locks
- Order square spindle separately



	8 mm	91451R07.X8*
--	------	--------------

	9 mm	91451R07.X9*
--	------	--------------

- * Met veer
- * Avec ressort
- * Mit Hochhaltefeder
- * Sprungloaded

- * Zonder veer
- * Sans ressort
- * Ohne Hochhaltefeder
- * Unsprung

Tessa Detour

Profieldeurbeslag / Quincaillerie de porte à chassis profil / Schmalrahmen / Profile door hardware



1H

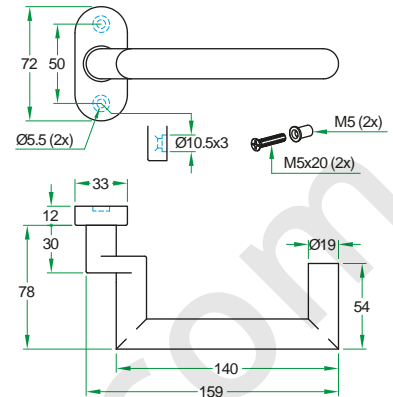

- 10 jaar garantie
- Hoogste norm: EN1906 klasse 4
- RVS deurkruk vastdraaibaar met veer
- Stalen onderconstructie gevuld met kunststof
- Geschikt voor sloten met meerpuntsluiting
- Stift separaat bestellen



- 10 ans de garantie
- La plus haute norme: EN1906 Classe 4
- Béquille fixe avec ressort de retenu
- Sous-construction en acier montée sur une embase en nylon
- Approprié pour serrures multipoints
- Tige carrée à commander séparément



- 10 Jahre Garantie
- Höchste Norm: EN1906 Klasse 4
- Edelstahl Türdrücker festdrehbar mit Hochhaltefeder
- Stahl Unterkonstruktion gefüllt mit Kunststoff
- Geeignet für Mehrfachschlösser Vierkantstift separat bestellen



- 10 year guarantee
- Highest standard: EN1906 Grade 4
- Stainless steel lever sprungloaded
- Steel understructure filled with nylon
- Suitable for multipoint locks
- Order square spindle separately



	8 mm	91441R07.X8*
--	------	--------------

- * Met veer
- * Avec ressort
- * Mit Hochhaltefeder
- * Sprungloaded

	9 mm	91441R07.X9*
--	------	--------------

- * Zonder veer
- * Sans ressort
- * Ohne Hochhaltefeder
- * Unsprung

Rondo

Profieldeurbeslag / Quincaillerie de porte à chassis profil / Schmalrahmen / Profile door hardware

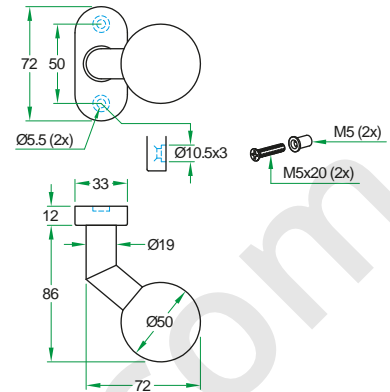

- 10 jaar garantie
- Hoogste norm: EN1906 klasse 4
- RVS deurkruk vastdraaibaar met veer
- Stalen onderconstructie gevuld met kunststof
- Geschikt voor sloten met meerpuntsluiting
- Stift separaat bestellen



- 10 ans de garantie
- La plus haute norme: EN1906 Classe 4
- Béquille fixe avec ressort de retenu
- Sous-structure en acier montée sur une embase en nylon
- Approprié pour serrures multipoints
- Tige carrée à commander séparément



- 10 Jahre Garantie
- Höchste Norm: EN1906 Klasse 4
- Edelstahl Türdrücker festdrehbar mit Hochhaltefeder
- Stahl Unterkonstruktion gefüllt mit Kunststoff
- Geeignet für Mehrfachschlösser Vierkantstift separat bestellen



- 10 year guarantee
- Highest standard: EN1906 Grade 4
- Stainless steel lever sprungloaded
- Steel understructure filled with nylon
- Suitable for multipoint locks
- Order square spindle separately



	8 mm	91401R07.X8*
--	------	--------------

- * Met veer
- * Avec ressort
- * Mit Hochhaltefeder
- * Sprungloaded

	9 mm	91401R07.X9*
--	------	--------------

- * Zonder veer
- * Sans ressort
- * Ohne Hochhaltefeder
- * Unsprung

COMPONENTEN / COMPOSANTS / ZUBEHÖR / COMPONENTS

Profieldeurbeslag / Quincaillerie de porte à chassis profil / Schmalrahmen / Profile door hardware

1H



- Knop vast op rozet
- Wisselstift separaat bestellen



- Bouton fixe sur rosace
- Fourni sans tige carrée



- Knopf fest auf Rosette
- Wechselstift nicht miteinbegriffen



- Knob fixed on rose
- Order knob spindle separately

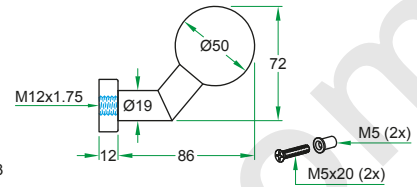
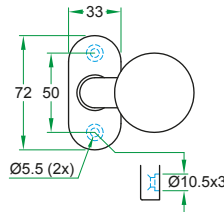

 **91380**



- Knop vast op rozet
- Wisselstift separaat bestellen



- Bouton fixe sur rosace
- Fourni sans tige carrée



- Knopf fest auf Rosette
- Wechselstift nicht miteinbegriffen



- Knob fixed on rose
- Order knob spindle separately

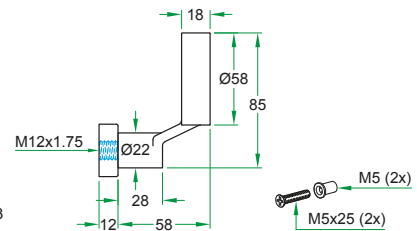
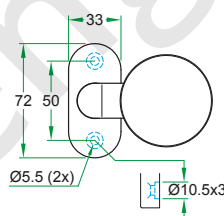

 **91381**

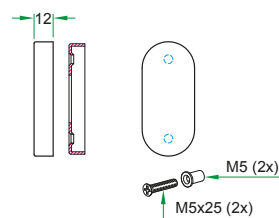
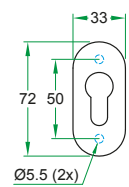

 **91382**

 **91383**

ROZETTEN / ROSACES / ROSETTEN / ROSES

Profieldeur / Porte à chassis profil / Schmalrahmen / Profile door



- Massief RVS rozet
- Schuifstelsysteem
- Met kerntrekbeveiliging
- Exclusief bevestigingsmateriaal



- Rosace inox massif
- Système targette
- Avec protection de cylindre
- Fourni sans vis de fixation



- Massiv Edelstahl Rosette
- Schiebeseystem
- Mit Kernziehschutz
- Befestigungsmaterial nicht miteinbegriffen



- Solid stainless steel rose
- Sliding system
- With cylinder protector
- Fixing screws not included

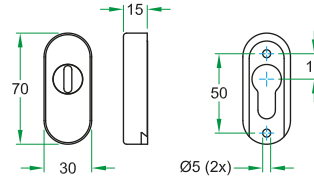

①	15 mm (H)	92455
---	-----------	-------



- Massief RVS rozet
- Schuifstelsysteem
- Exclusief bevestigingsmateriaal



- Rosace inox massif
- Système targette
- Fourni sans vis de fixation



- Massiv Edelstahl Rosette
- Schiebeseystem
- Befestigungsmaterial nicht miteinbegriffen



- Solid stainless steel rose
- Sliding system
- Fixing screws not included

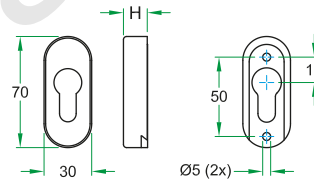

①	15 mm (H)	92452
	10 mm (H)	92451
	6 mm (H)	92450



- Massief RVS rozet
- Schuifstelsysteem
- Exclusief bevestigingsmateriaal



- Rosace inox massif
- Système targette
- Fourni sans vis de fixation



- Massiv Edelstahl Rosette
- Schiebeseystem
- Befestigungsmaterial nicht miteinbegriffen





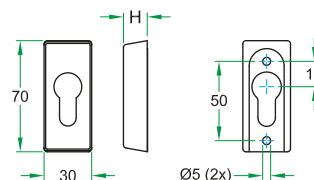



- Solid stainless steel rose
- Sliding system
- Fixing screws not included

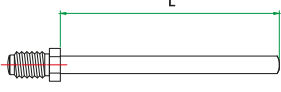

①	15 mm (H)	92462
	10 mm (H)	92461
	6 mm (H)	92460

-  **Komponenten profieldeurbeslag**
-  **Composants de fixation béquille de porte à chassis profil**
-  **Zubehör Rohrahmen Garnituren**
-  **Components for profile door hardware**

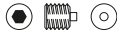
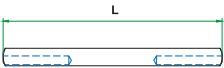
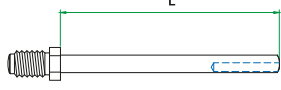
1H

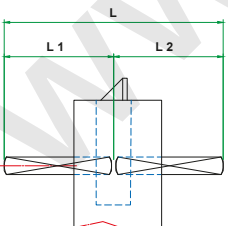
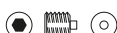
EN 1906 4	Vierkant Carré Vierkant Square	Massief Massif Massiv Solid	□L	Graving Gravure Grafierung Engraving	Artikelnr. Code d'article Artikelnr. Article code
	M6				27027*
	8 mm	✓	110 mm	EN 1906	93112
	8 mm	✓	130 mm	EN 1906	93111
	M12 / 8 mm	✓	80 mm	EN 1906	93113
	M12 / 8 mm	✓	120 mm	EN 1906	93129
 DIN 18273	Vierkant Carré Vierkant Square		□L	Graving Gravure Grafierung Engraving	Artikelnr. Code d'article Artikelnr. Article code
	M6				93180*
	9 mm	✓	110 mm	DIN 18273 FS	93114
	9 mm	✓	130 mm	DIN 18273 FS	93116
	M12 / 9 mm	✓	80 mm	DIN 18273 FS	93115
	M12 / 9 mm	✓	120 mm	DIN 18273 FS	93130
 EN 179	Anti-paniek Antipanique Anti Panik Anti Panic	Massief Massif Massiv Solid	□L		Artikelnr. Code d'article Artikelnr. Article code
	9 mm	✓	L1/L2-lengte L1/L2- longueur L1/L2- Länge L1/L2-length	110 mm	93185
	9 mm	✓	55 / 55 mm	130 mm	93186
	M6				27027

Langere stift lengtes op aanvraag verkrijgbaar.
Carrés plus longue sont en vente à demande.
Verlängerte Stiften verfügbar laut Anfrage.
Longer spindles are available upon inquiry.

- * Standaard meegeleverd in garnituur.
- * Fourni standard avec garniture.
- * Standard beim Garnitur miteinbegriffen.
- * Standard included in each lever set.

Schuifdeur

Porte coulissante

Schiebetür

Sliding door





Project: ROC Lammenschans
Architect: MVSA



Chase 102



Chase 103



Chase 104



01018 106



01021 106

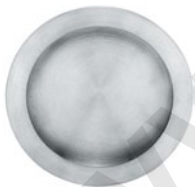

01022 107

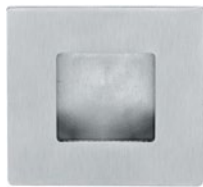

01023 107



01024 108

Chase

Schuifdeurbeslag / Porte coulissante / Schiebetür / Sliding door

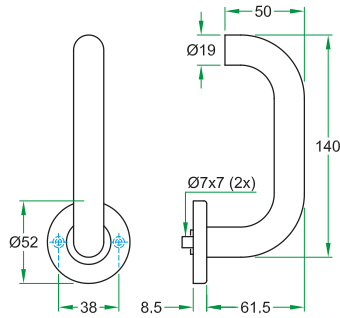

- Verticale RVS deurkruk vastdraaibaar met veer op rozet
- Stalen onderconstructie



- Béquille verticale inox fixe avec ressort de retenue sur rosace
- Sous-construction en acier



- Vertikaler Edelstahl Drücker festdrehbar mit Hochhaltefeder auf Rosette
- Stahl Unterkonstruktion



- Vertical stainless steel lever
- fixed with spring on rose
- Steel understructure

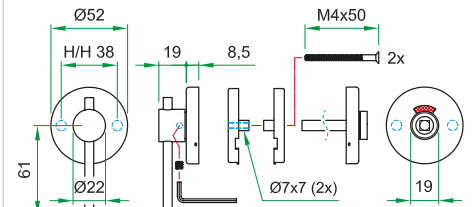
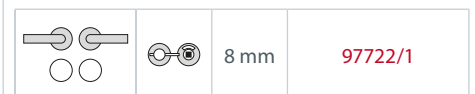
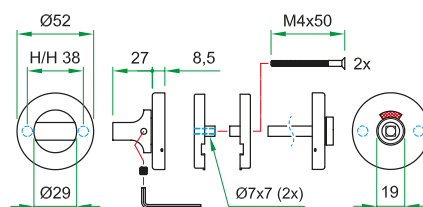
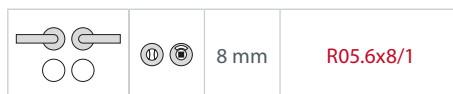

Chase

Schuifdeurbeslag / Porte coulissante / Schiebetür / Sliding door

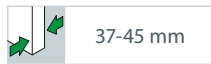
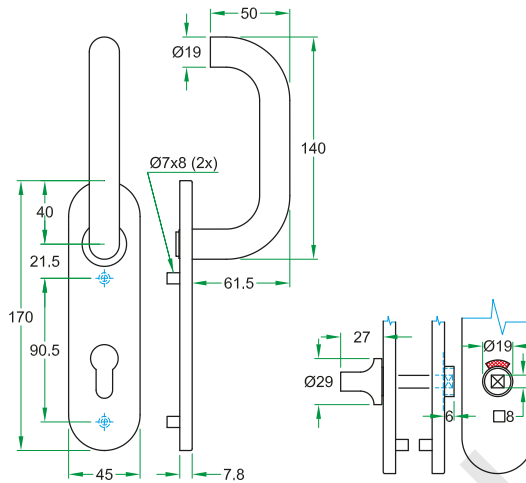

- Verticale RVS deurkruk vastdraaibaar met veer op kortschild
- Stalen onderconstructie



- Béquille verticale inox fixe avec ressort de retenue sur plaque courte
- Sous-construction en acier



- Vertikaler Edelstahl Drücker festdrehbar mit Hochhaltefeder auf Kurzschild
- Stahl Unterkonstruktion



- Vertical stainless steel lever
- fixed with spring on shortplate
- Steel understructure



		-	EN91050KV00.58
		72 mm	EN91050KV72.38

		72 mm	EN91050KV72.681

Chase

Schuifdeurbeslag / Porte coulissante / Schiebetür / Sliding door

11

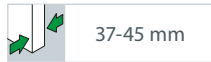
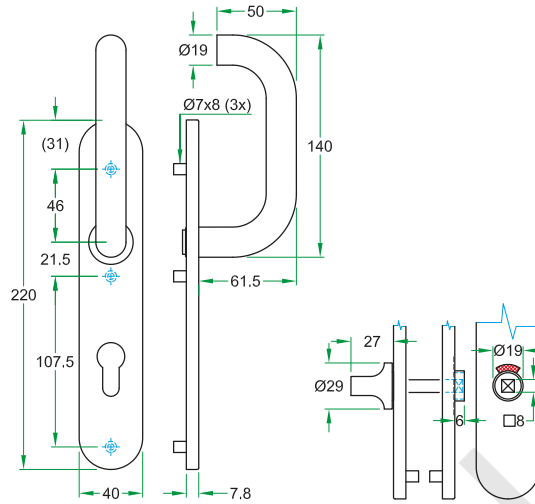

- Verticale RVS deurkruk vastdraaibaar met veer op langschild
- Stalen onderconstructie



- Béquille verticale inox fixe avec ressort de retenue sur plaque longue
- Sous-construction en acier



- Vertikaler Edelstahl Drücker
- festdrehbar mit Hochhaltefeder auf Langschild
- Stahl Unterkonstruktion



- Vertical stainless steel lever
- fixed with spring on longplate
- Steel understructure



		-	EN91050BV00.58
		72 mm	EN91050BV72.38

		72 mm	EN91050BV72.681

-  **ONDERDELEN Verlengde stiften en schroeven**
-  **ACCESSOIRES Tiges e vis allongées**
-  **ZUBEHÖR verlängerte Stifte und Schrauben**
-  **PARTS extended spindles and screws**

Massief 45H staal
Acier 45D massif
Massiv 45H Stahl
Solid 45H Steel

□ L

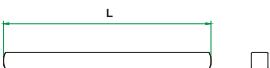
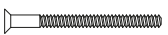
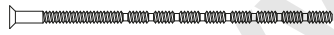

Artikelnr.
Code d'article
Artikelnr.
Article code

		M6				27027*
		□ 8 mm	✓	110 mm*	max 58 mm	93120*
		□ 8 mm	✓	130 mm	max 71 mm	93111
		□ 8 mm	✓	160 mm	max 100 mm	93120-160
	Rozet/Rosace Rosette/Rose	M4	Staal/Acier Stahl/Steel	50 mm*	36-45 mm	27029*
	Kortschild/Plaque courte Kurzschild/Shortplate	M4	Staal/Acier Stahl/Steel	50 mm*	36-45 mm	27080*
	Langschild/Plaque longue Langschild/Longplate	M4	Staal/Acier Stahl/Steel	50 mm*	36-45 mm	27081*
		M4	Staal/Acier Stahl/Steel	60 mm	46-55 mm	27084
		M4	Staal/Acier Stahl/Steel	70 mm	56-65 mm	93234-70
		M4	Staal/Acier Stahl/Steel	80 mm	66-75 mm	93234-80
		M4	Staal/Acier Stahl/Steel	90 mm	76-85 mm	93234-90
		M4	Staal/Acier Stahl/Steel	100 mm	86-95 mm	93234-100
		M4	Staal/Acier Stahl/Steel	120 mm	100 mm	93107

- * Standaard meegeleverd in garnituur.
- * Fourni standard avec garniture.
- * Standard beim Garnitur miteinbegriffen.
- * Standard included in each lever set.

Schuifdeurkommen / Cuvettes / Schiebetürmuschel / Sliding pulls

RVS / Inox / Edelstahl / Stainless steel

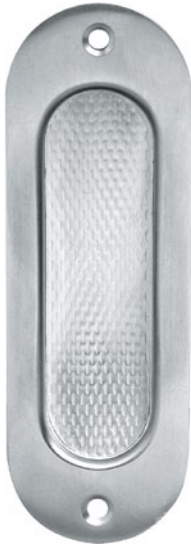

- Ovale schuifdeurkom
- RVS mat geborsteld



- Cuvette ovale
- Inox mat brossé



- Ovale Schiebetürmuschel
- Edelstahl matt gebürstet



- Oval sliding pull
- Satin stainless steel

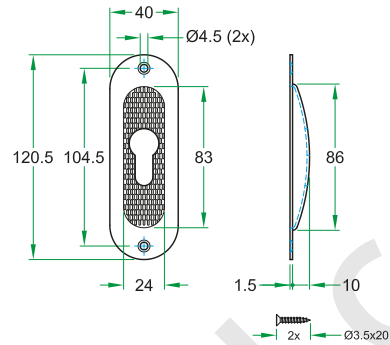

	01018
	01018/BB
	01018/PC



- Rechthoekige schuifdeurkom
- RVS mat geborsteld



- Cuvette rectangulaire
- Inox mat brossé



- Rechteckige Schiebetürmuschel
- Edelstahl matt gebürstet



- Rectangular sliding pull
- Satin stainless steel

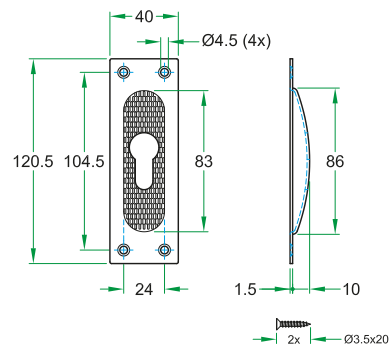

	01021
	01021/BB
	01021/PC

Schuifdeurkommen / Cuvettes / Schiebetürmuschel / Sliding pulls

RVS / Inox / Edelstahl / Stainless steel



- Ronde schuifdeurkom zonder sleutelgat
- RVS mat geborsteld



- Cuvette ronde sans BB
- Inox mat brossé



- Runde Schiebetürmuschel ohne Schlüsselloch
- Edelstahl matt gebürstet



- Round sliding pull without key hole
- Satin stainless steel

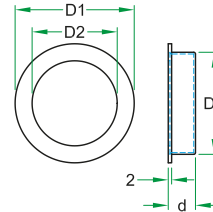

Art. Nr.	D1 mm	D2 mm	D3 mm	d mm
01022/40	Ø40	Ø27	Ø35	12
01022/50	Ø50	Ø33	Ø40	12
01022/70	Ø70	Ø50	Ø60	16

Ø 40 mm	01022/40
Ø 50 mm	01022/50
Ø 70 mm	01022/70



- Vierkante schuifdeurkom met gecentreerd gat zonder sleutelgat
- RVS mat geborsteld



- Cuvette carrée centré sans BB
- Inox mat brossé



- Eckige Schiebetürmuschel zentrierte Lochung ohne Schlüsselloch
- Edelstahl matt gebürstet



- Square sliding pull centered hole without key hole
- Satin stainless steel

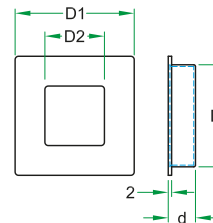
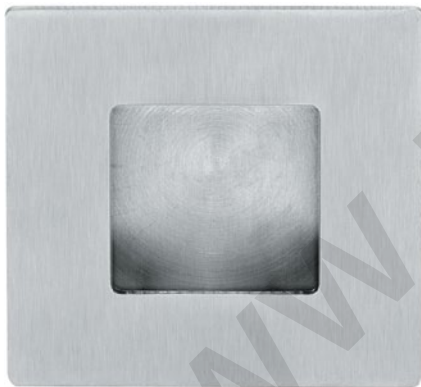

Art. Nr.	D1 mm	D2 mm	D3 mm	d mm
01023/50	□50	□23	Ø40	12
01023/70	□70	□35	Ø60	16

50 mm	01023/50
70 mm	01023/70

Schuifdeurkommen / Cuvettes / Schiebetürmuschel / Sliding pulls

RVS / Inox / Edelstahl / Stainless steel

11

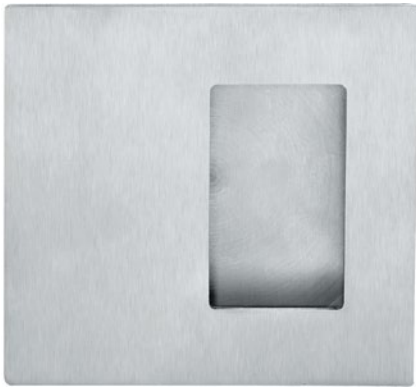

- Vierkante schuifdeurkom met gecentreerd gat zonder sleutelgat
- RVS mat geborsteld



- Cuvette carrée centré sans BB
- Inox mat brossé



- Eckige Schiebetürmuschel zentrierte Lochung ohne Schlüsselloch
- Edelstahl matt gebürstet



- Square sliding pull centered hole without key hole
- Satin stainless steel

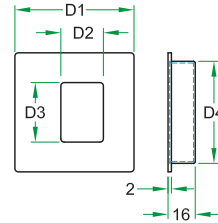

Art. Nr.	D1 mm	D2 mm	D3 mm	D4 mm
01024/70	□70	25	35	∅60

70 mm

01024/70

Projectsloten

Serrures de projets

Einsteckschlößer

Mortice locks



Projectsloten

Serrures de projets

1J



- Zeer sterk projectslot voor utiliteitsgebouwen dat moeiteloos zware en druk belopen deuren aankan
- RVS voorplaat, dagschoot, nachtschoot en tuimelaar. Voor uniforme uitstraling, brandwerendheid en extra sterkte
- Gecertificeerd conform:
 - EN12209 - klasse 3 (EU norm)
 - DIN 18251 - klasse 3 (Duitse gebruiksnorm)
 - EN 1634-2 (EU norm brandwerend)
- Hoogste corrosiewerendheid (240 uur) conform EN12209
- Standaard met brandwerendheid conform EN1634-2
- Doornmaat 60 mm



- Serrures de projets très solides en pour les bâtiments utilitaires qui peuvent facilement gérer l'utilisation des portes lourdes et très utilisées
- Têtière en acier inoxydable, pêne lançant, pêne dormant et fouillot (aussi nommé noix). Pour un aspect uniforme, extra solide et une résistance au feu
- Certifié selon les normes:
 - EN 12209-classe 3 Norme européenne d'utilisation
 - DIN 18251-classe 3 Norme allemande d'utilisation
 - EN 1634-2 Norme européenne contre la résistance au feu
- Résistance à la corrosion la plus élevée (240 heures) selon la norme EN12209
- Résistance au feu selon la norme EN1634-2
- Axe à 60 mm

- 1** RVS afgeronde voorplaat. 235 x 20 x 3 mm
- 2** RVS dagschoot. Dus geen staal of zamak. Gecertificeerd op >200,000 bedieningen en grote dwarskrachten
- 3** RVS dagschoot eenvoudig omkeerbaar. Dus voor DIN-Links & -Rechts toepasbaar
- 4** Stofbussen tegen vuil-indringing bij montage van het deurbeslag
- 5** RVS tuimelaar voor extra sterkte. Met klem ter vermindering van stift-tolerantie (klemtuimelaar). T.b.v. 8 x 8 mm stift
- 6** Volledig verzinkte slotkast
- 7** RVS nachtschoot. Dus geen staal of zamak

Têtière arrondie en **acier inoxydable**. 235 x 20 x 3 mm

Pêne lançant en **acier inoxydable**. Donc, pas d'acier ou d'alliage de zinc. Certifié sur > de 200.000 utilisations et forces transversales

Pêne en **acier inoxydable** facilement réversible. Donc, pour applications à gauche et à droite

Tubes de prévention contre les poussières indésirables pendant le montage des poignets

Tige en **acier inoxydable** pour une plus grande résistance. Avec crochet pour diminuer l'usure de la tige. Pour tige carré 8 x 8 mm

Coffre de la serrure entièrement galvanisé

Pêne dormant en **acier inoxydable**. Donc pas d'acier ou d'alliage de zinc



Einsteckschlößer

Mortice locks



- Einsteckschloß für Objektüren mit hoher Benutzerfrequenz und Belastung
- Edelstahl Stulp, Falle, Riegel und Klemmnuß. Für uniforme Ausstrahlung, Feuerhemmung und hohe Stärke
- Geprüft und zertifiziert nach:
 - EN12209 - Klasse 3 (EU Norm Gebrauch)
 - DIN 18251 - Klasse 3 (DIN Gebrauchsnorm)
 - EN 1634-2 (EU Norm Feuerhemmung)
- Höchste Korrosionswiderstand (240 Stunden) nach EN12209
- Standard mit Feuerhemmung laut EN1634-2
- 60 mm Dornmaß

- 1** **Edelstahl** Stulp. 235 x 20 x 3 mm. Rund
- 2** **Edelstahl** Falle
- 3** **Edelstahl** Falle einfach Links/Rechts verwendbar.
- 4** Späneschutzhülsen verhindern bei der Beschlagsmontage, dass Bohrspäne in das Schloß gelangen und die Funktion beeinträchtigen
- 5** Klemmnuß aus **Edelstahl**
Nußvierkant: 8 x 8 mm Die Klemmnuß garantiert eine spielfreie Verbindung zwischen Schloß und Türdrückerstift
- 6** Voll verzinkte Gehäuse
- 7** **Edelstahl** Riegel



- Very strong mortice lock for public buildings. Easily handles intense usage and heavy doors
- Stainless steel forend, latch, deadbolt and follower. For uniform appearance, fire-resistance and additional durability
- Certified according to:
 - EN12209 - class 3 (EU norm for usage)
 - DIN 18251 - class 3 (German usage norm)
 - EN1634-2 (EU norm fire-resistance)
- Highest corrosion resistance (240 hours) according to EN12209
- Fire-rated according to EN1634-2
- Backset 60 mm

Stainless steel forend.
Rounded, 235 x 20 x 3 mm

Stainless steel latch. So not made of zinc or steel. Certified for > 200.000 cycles and strong lateral force

Quick reversible **Stainless steel** latch for left and right hand applications

Dust prevention tubes through the fixing holes

Stainless steel follower for extra strength. With spindle grip for reduced spindle movement. Size 8 x 8 mm

Complete galvanised case

Stainless steel dead bolt.
So not of zinc or steel



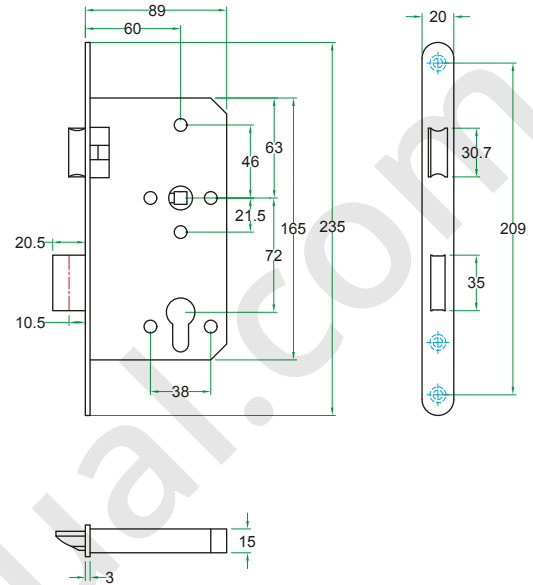
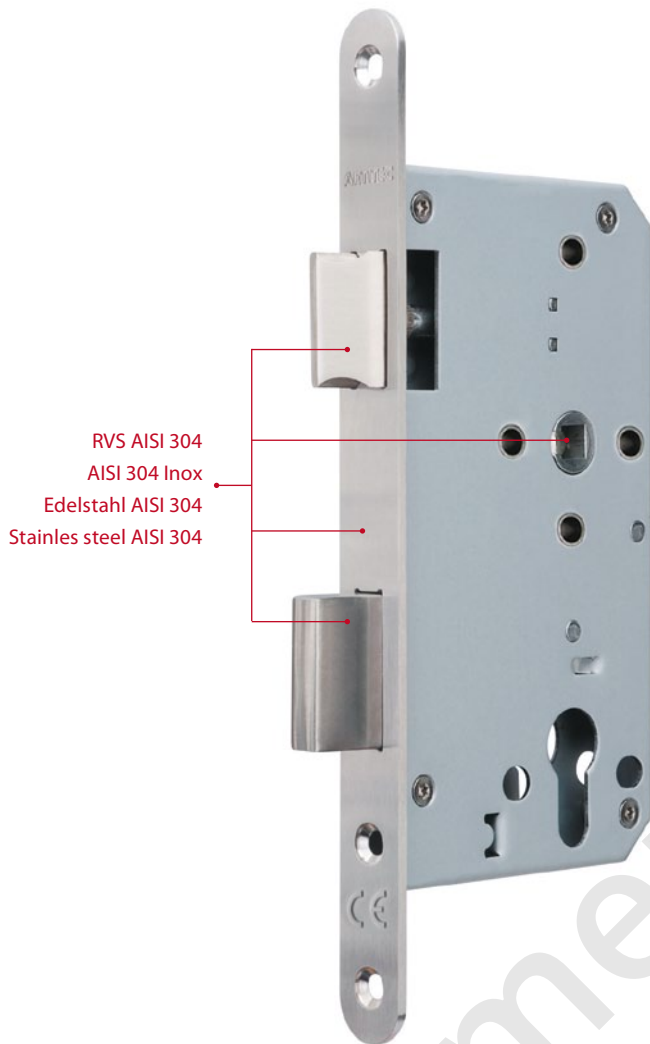

72 mm 9420.U2060.PC72



- Zeer sterk projectslot voor utiliteitsgebouwen dat moeiteloos zware en druk belopen deuren aankan
- RVS voorplaat, dagschoot, nachtschoot en tuimelaar. Voor uniforme uitstraling, brandwerendheid en extra sterkte
- Gecertificeerd conform:
 - EN12209 - klasse 3 (EU norm gebruik)
 - DIN 18251 - klasse 3 (Duitse gebruikersnorm)
 - EN 1634-2 (EU norm brandwerend)
- Hoogste corrosiewerendheid (240 uur) conform EN12209
- Standaard met brandwerendheid conform EN 1634-2
- Doornmaat 60 mm
- Dagschoot eenvoudig omkeerbaar



- Serrures de projets très solides en pour les bâtiments utilitaires qui peuvent facilement gérer l'utilisation des portes lourdes et très utilisées
- Plaque en acier inoxydable, pêne lançant, pêne dormant et fouillot (aussi nommé noix). Pour un aspect uniforme, extra solide et une résistance au feu
- Certifié selon les normes:
 - EN 12209-classe 3 Norme européenne d'utilisation
 - DIN 18251-classe 3 Norme allemande d'utilisation
 - EN 1634-2 Norme européenne contre la résistance au feu
- Résistance à la corrosion la plus élevée (240 heures) selon la norme EN12209
- Résistance au feu selon la norme EN1634-2
- Axe à 60 mm
- Pêne facilement réversible



- Einsteckschloss für Objektüren mit hoher Benutzerfrequenz und Belastung
- Edelstahl Stulp, Falle, Riegel und Klemmnuss. Für uniforme Ausstrahlung, Feuerhemmung und hohe Stärke
- Geprüft und zertifiziert nach:
 - EN12209 - Klasse 3 (EU Norm Gebrauch)
 - DIN 18251 - Klasse 3 (DIN Gebrauchsnorm)
 - EN 1634-2 (EU Norm Feuerhemmung)
- Höchste Korrosionswiderstand (240 Stunden) nach EN12209
- Standard mit Feuerhemmung laut EN1634-2
- 60 mm Doornmass
- Fallenkopf einfach drehbar
- DIN links bzw. DIN rechts



- Very strong mortice lock for public buildings. Easily handles intense usage and heavy doors
- Stainless steel forend, latch, deadbolt and follower. For uniform appearance, fire-resistance and additional durability
- Certified according to:
 - EN12209 - class 3 (EU norm for usage)
 - DIN 18251 - class 3 (German usage norm)
 - EN1634-2 (EU norm fire-resistance)
- Highest corrosion resistance (240 hours) according to EN12209
- Fire-resistant according to EN1634-2
- Backset 60 mm
- Quick reverse latch

Projectsloten / Serrures de projets / Einsteckschlößer / Mortice locks



9420.U2060.PL



• Loopslot



• Serrure lancant



• Fallenschloss für Innentüre



• Latch lock

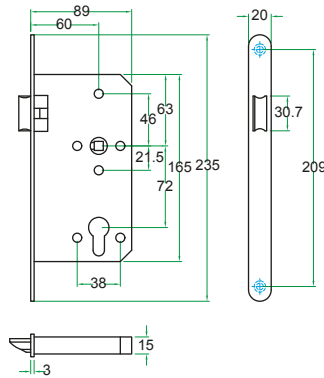

72 mm	9420.U2060.WC72
78 mm	9420.U2060.WC78



• Vrij/bezet slot



• Serrure de toilet



• Fallen-riegelschloss für Badezellentüre



• Bathroom lock

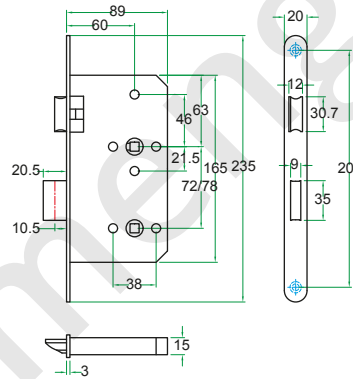

• Centraalportiek/
Centraalslot
• Met dagschoot-
blokkering, met wissel



• Serrure à cylindre



• Fallenschloss für Eingangstüre
• PZ vorgerichtet,
mit Wechselfunktion,
mit automatischer
Fallenverriegelung



• Night latch lock



72 mm 9420.U2060.NL

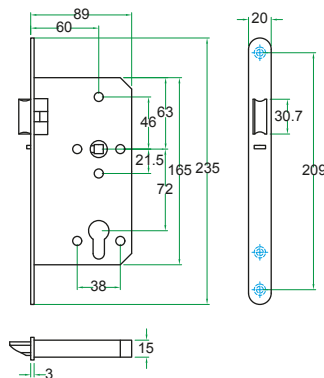

Projectsloten / Serrures de projets / Einsteckschlößer / Mortice locks

1J



9420.U2060.DL



• Kastslot/
Cilinder nachtslot



• Serrure dormant
à cylindre



• Riegelschloss für
Eingangstüre
PZ vorbereitet,
DIN links bzw.
DIN rechts



• Dead lock lock

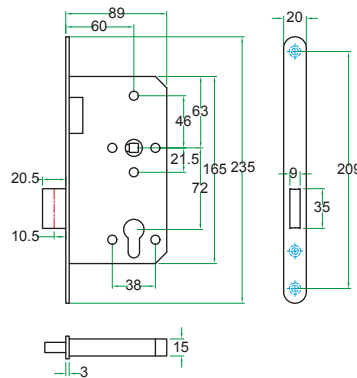

• Ton rolslot



• Serrure à rouleau à
cylindre



• Rollenschloß



• Roller bolt lock



9420.U2060.RB

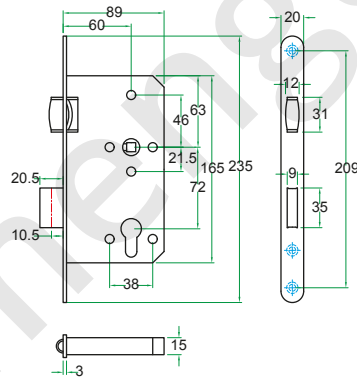

Voet-opener

Ouvrier de pied

Fußöffner

Foot-opener





Project: Brightland chemlot Campus Center Court
Architect: Ector Hoogstad Architects

Voet-opener / Ouvrier de pied / Fußöffner / Foot-opener

RVS / Inox / Edelstahl / Stainless steel



Onbewust komen we allemaal in aanraking met onzichtbare bacteriën en bacillen via een kruk of deurgreep. Onze voet-opener is de handsfree oplossing voor toegangsdeuren naar openbare toiletgroepen.

Inconscience nous tous venons en contact avec les bactéries et les bacilles invisibles par une béquille ou un tirant. Notre ouvrier de pied est la solution mains libres pour portes d'accès aux toilettes publiques.

Unbewußt kommen wir allen in Kontakt mit Bakterien und Bazillen durch einen Drücker oder Stoßgriff. Unsere Fußöffner ist die händen freie Lösung für Zugangstüren nach öffentliche Toiletten.

Unconsciously we all get in touch with bacteria and bacilli via a lever or pull handle. Our foot-opener is the handsfree solution for access doors to public toilets.

92045



- RVS voet-opener, mat geborsteld
- Incl. bevestigingsmateriaal



- Ouvrier de pied en inox massif, mat brossé
- Fourni incl. matériel de montage



- Edelstahl Fußöffner, matt gebürstet
- Montageschrauben miteingegriffen



- Stainless steel foot-opener, satin finish
- Includes fixing screws

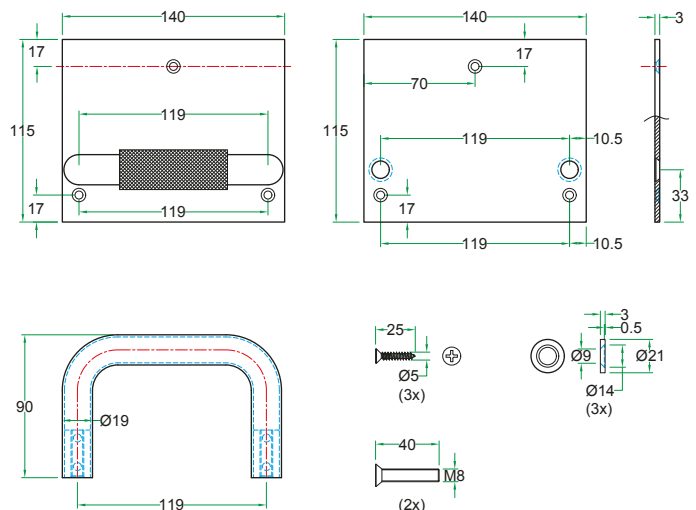

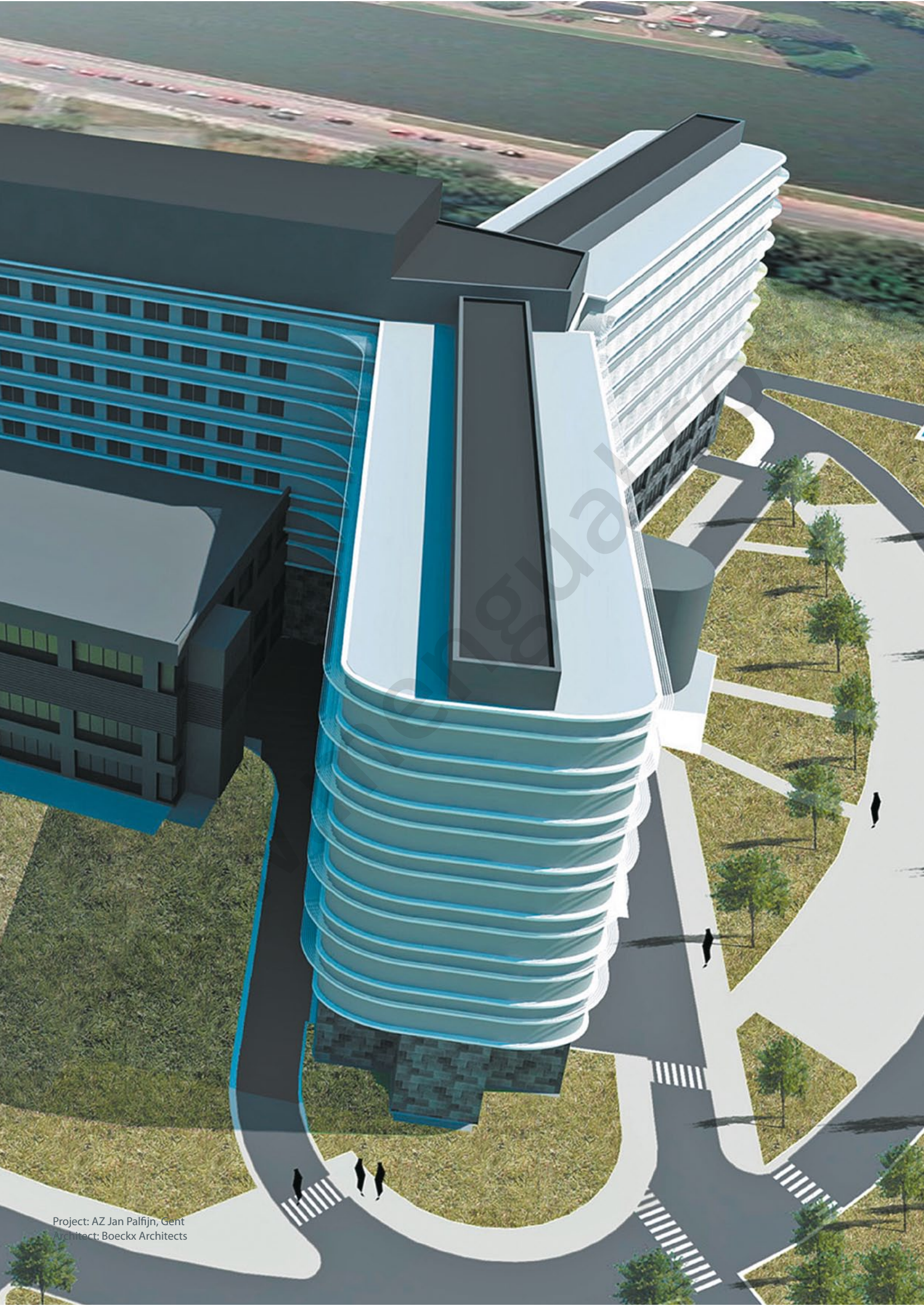

Project: AZ Jan Palfijn, Gent
Architect: Boeckx Architects

 Zorg & Welzijn - binnendeuren

 Soins & Bien-être - portes intérieures

 Pflege & Wohl - Innentüren

 Care & Welfare - Interior doors

Infectiepreventie

Prévention des infections

2A



◀ VERSUS ▶

Antimicrobial
Copper



- Snelle en effectieve anti-microbiële werking.
- Uniek! Vernietigt ook de restanten van de gedode bacteriën.
- Zelfreinigend (superhydrophilicity).
- Onzichtbare coating. RVS uitstraling blijft.
- Al meer dan 4 jaar toegepast in diverse zorginstellingen.
- Bevat geen microban of zilver ionen (achterhaalde technologieën).
- Artitec's gehele Utiliteitsbouw assortiment verkrijgbaar in HC3
- Vereist UV licht ter activatie

- Snelle en effectieve antimicrobiële werking.
- Effectiever dan coatings met zilver-ionen
- Van nature antimicrobieel, geen toegevoegde chemicaliën
- Geen esthetisch compromis. Ziet eruit als RVS
- Vol materiaal. Slijt dus niet zoals een coating
- Kan schoongemaakt worden zoals andere oppervlakten
- Blijft effectief. Zelfs na herhaaldelijke krassen en contaminaties
- Natuurlijke oxidatie vermindert niet de effectiviteit
- Volledig recyclebaar materiaal



◀ PAR RAPPORT À ▶

Antimicrobial
Copper



- Um effer anti microbien réel et rapide.
- Unique! Détruit aussi les restes des bactéries mortes.
- Autonettoyant (superhydrophilicity).
- Revêtement invisible. L'apparence d'acier inox reste.
- Pour plus de 4 ans appliquées dans divers établissements de soins de santé.
- Sans microban ou ions d'argent (technologies obsolètes).

- Un effer antimicrobien réel et rapide.
- Plus efficace que revêtements contenant des ions d'argent.
- Naturellement antimicrobien: aucun produit chimique ajouté.
- Plus efficace que revêtements contenant des ions d'argent.
- Matériau massive. Porter non pas comme un revêtement.
- Peut être nettoyé comme les autres surfaces
- Reste en vigueur. Même après des cycles répétitifs d'abrasions sèche et humide ainsi que par recontamination.
- L'oxydation naturelle ne freine absolument pas l'efficacité.
- Totalement recyclable, indéfiniment et sans perte de ses propriétés.

Infektion Prävention

Infektion prevention



◀ IM VERGLEICH ZU ▶

Antimicrobial
Copper



2A

- Schnelle und effektive antimikrobielle Wirkung.
- Einzigartig! Vernichtet auch die Überreste der getöteten Bakterien.
- Selbstreinigend (Superhydrophil).
- Unsichtbare Beschichtung. ES-look bleibt.
- Seit mehr als 4 Jahren in verschiedenen Pflegeeinrichtungen angewendet.
- Enthält keine Microban oder Silber-Ionen (veraltete Technologien).

- Schnelle und effektive antimikrobielle Wirkung.
- Effektiver als Beschichtungen mit Silber-Ionen
- Natürlich antimikrobiell, ohne Zusatz von Chemikalien.
- Keine ästhetische Kompromisse, sieht aus wie Edelstahl.
- Vollmaterial. Tragen sich also nicht als Beschichtung.
- Kann wie andere Oberflächen gereinigt werden.
- Bleibt wirksam. Auch nach wiederholten Kratzer und Verunreinigungen.
- Natürliche Oxidation reduziert die Wirksamkeit
- Vollständig recycelbarem Material



◀ VERSUS ▶

Antimicrobial
Copper



- Fast and effective antimicrobial effect.
- Unique! Also destroys the residue left behind by the killed bacteria.
- Self-cleaning (superhydrophilicity).
- Invisible coating. Stainless steel appearance remains.
- Used for more than 4 years in various care institutions.
- Does not contain Microban or silver ions (obsolete technologies).
- Artitec's whole Commercial range available in HC3
- Requires UV light for activation

- Fast and effective antimicrobial function
- More effective than silver-containing coatings
- Natural antimicrobial - no chemicals added
- No esthetic compromises. Looks like stainless steel
- Solid material, won't wear away—unlike a coating
- Can be cleaned in the same way as non-copper surfaces
- Remains effective even after repeated wet and dry abrasion and re-contamination
- Natural oxidation does not impair efficacy.
- Completely recyclable.

80%

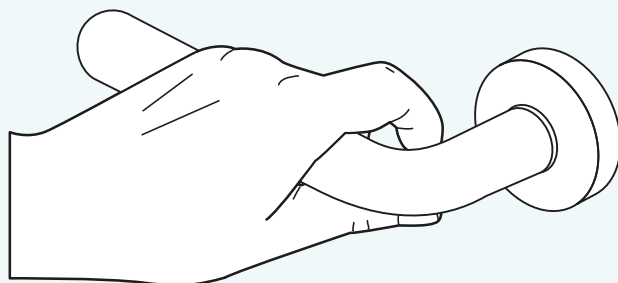

Wist u, dat 80% van infecties door handcontact overgedragen wordt?¹



Saviez-vous que 80% des infections est transmises par le contact des mains?¹



Wussten Sie, dass 80% der Infektionen durch Handkontakt übertragen wird?¹



Did you know, that 80% of infections is passed on through handcontact?¹

¹The secret life of germs', P.M. Tierno

40%

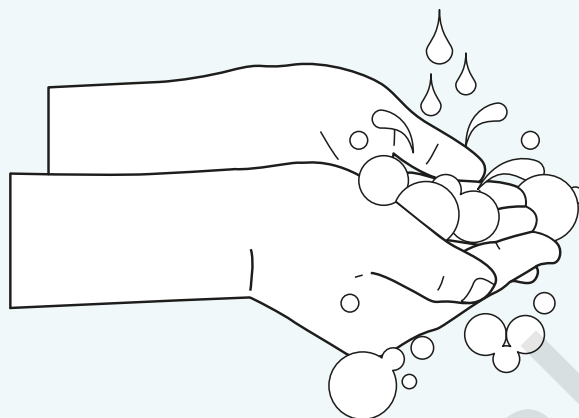

En dat minder dan 40% van werknemers in de gezondheidszorg zich houden aan de handhygiëne protocollen?²

Ziekenhuisinfecties is een zorg in Europa

1 in 3 Een derde van patiënten in intensive care afdelingen (ICUs) raken besmet met ten minste 1 ziekenhuisinfectie

7% Van elke 100 ziekenhuispatienten, lopen 7 patienten een ziekenhuisbacterie op

1 in 4 Een kwart van ziekenhuisinfecties bij langere termijn intensieve zorg worden veroorzaakt door resistente bacteria

Bronnen

CDC Vital Signs Report 2016
WHO Healthcare-Associated Infections, Fact Sheet, 2014
WHO The Burden of Health Care-Associated Infections worldwide: A Summary, 2010



Et que seulement 40% des professionnels de la santé suivent correctement le protocole officiel d'hygiène des mains?²

Les infections associées aux soins sont une préoccupation en Europe

1 sur 3 Un tiers des patients hospitalisés dans des unités de soins intensifs sont atteints par au moins une infection nosocomiale

7% Sur 100 patients hospitalisés, 7 vont contracter au moins une infection nosocomiale

1 sur 4 Un quart des infections nosocomiales dans les centres de soins intensifs de long terme sont causées par des bactéries résistantes aux antibiotiques

Sources

CDC, Rapport 'Signes Vitaux', 2016
OMS, Fiche 2014 sur les Infections Nosocomiales
OMS, Le fardeau sanitaire généré par les soins des infections dans le monde : Résumé 2010



Und weniger als 40% der Mitarbeiter im Gesundheitswesen die Händehygiene korrekt befolgen?²

Krankenhausinfektionen sind ein Thema in Europa

1 aus 3 Ein Drittel der Patienten im Intensivstation werden mit mindestens einer Krankenhausinfektion infiziert

7% 7 der 100 Krankenhauspatienten ziehen sich eine Krankenhausbakterie zu

1 aus 4 Ein Viertel der Krankenhausinfektionen bei langläufiger Intensivpflege wird verursacht durch resistente Bakterien

Herkunft



And that as few as 40% of Healthcare workers correctly follow the official Hand hygiene protocol?²

Healthcare-associated infections are a concern in Europe

1 in 3 A third of patients in intensive care units (ICUs) are affected by at least 1 healthcare-associated infection

7% Of every 100 hospitalized patients, 7 will acquire at least 1 healthcare-associated infection

1 in 4 A quarter of healthcare-associated infections in long-term acute care settings are caused by antibiotic-resistant bacteria

Sources

CDC Vital Signs Report 2016
WHO Healthcare-Associated Infections, Fact Sheet, 2014
WHO The Burden of Health Care-Associated Infections worldwide: A Summary, 2010

² WHO guidelines on hand hygiene in health care, World Health Organization

ZIEKENHUIS
ST ANTONIUS

Chase

Antimicrobiëel / Antimicobien / Antimikrobiel / Antimicrobial

Antimicrobial
Copper

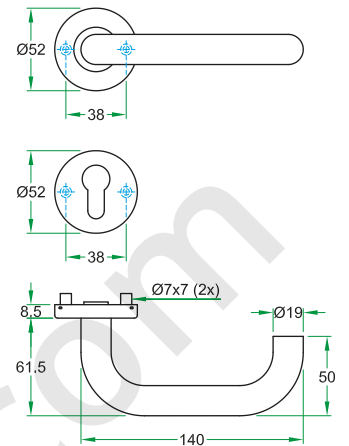
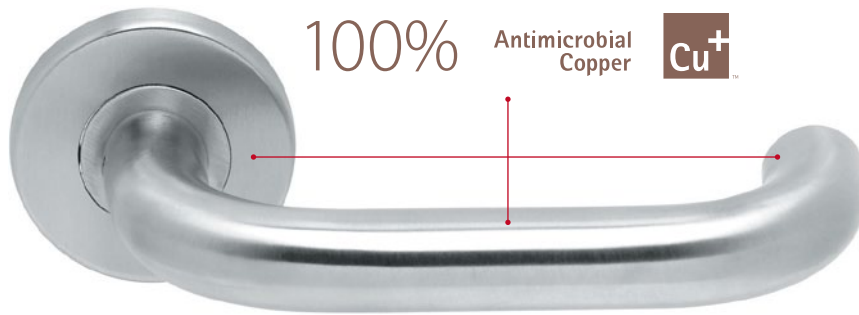

2A



- Antimicrobieel koper, géén coating
- Effectiever dan coatings met zilver-ionen
- Speciale koperlegering, uitstraling van RVS
- Deurkruk vastdraaibaar met veer
- Stalen onderconstructie



- Cuivre antimicrobien, sans revêtement
- Plus efficace que les revêtements contenant des ions d'argent
- Alliage spécial de cuivre, ressemble à de l'acier inoxydable
- Béquille en cuivre fixe avec ressort
- Sous-structure en acier



- Antimicrobielle Kupfer
- Effektiver als Beschichtungen mit Silber-Ionen
- Spezielle Kupferlegierung, Seht aus wie Edelstahl
- Drücker festdrehbar mit Hochhaltefeder
- Stahl Unterkonstruktion



- Antimicrobial copper, not a coating
- More effective than silver-containing coatings
- Special alloy, looks just like stainless steel
- Spring-loaded lever
- Steel understructure



CU27025

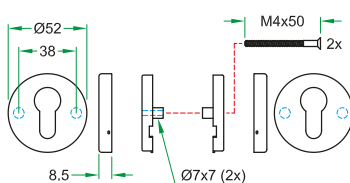

CUR05.6X8

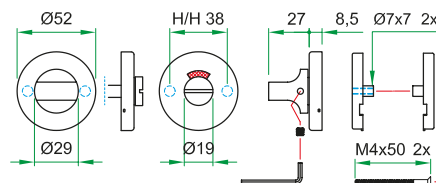

CU96140

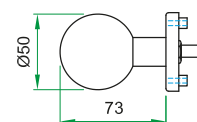

Informeer naar onze separate brochure 'Zorg & Welzijn' voor uitgebreider assortiment en verdere toepassingen.
 Pour plus d'informations consultez notre brochure 'Soins & Bien-être' avec un assortiment plus détaillé et les applications plus avants.
 Für weitere Informationen fordern Sie bitte unsere Broschüre 'Pflege & Wohl' an, die das gesamte Sortiment und weitere Anwendungen beinhaltet.
 For more information request our separate brochure 'Care & Welfare' for a wider assortment and other applications.

HC3 Anti-microbiële coating

Extra preventiemiddel tegen ziekenhuisbacteriën



2B

Voornaamste eigenschappen HC3

- Snelle en effectieve anti-microbiële werking.
- Uniek! Vernietigt ook de restanten van de gedode bacteriën.
- Zelfreinigend (superhydrophilicity).
- Onzichtbaar. RVS uitstraling blijft.
- Al meer dan 4 jaar toegepast in diverse zorginstellingen.
- Bevat geen microban of zilver ionen (achterhaalde technologieën).

Referenties:

- Ziekenhuis Jan Palfijn, Gent
- Ziekenhuis, Geraardsbergen
- Zorgcentrum Ter hovingen, Gentbrugge
- School OLVP, Bornem
- Ziekenhuis Sint Augustinus, Veurne
- University College Hospital, Londen
- Queens Medical Centre, Nottingham
- Al Wakra Hospital, Qatar
- Royal Pilgrim Hospital, Boston

HC3 is verkrijgbaar
op al ons projectbeslag
Meer informatie:
www.artitec.com

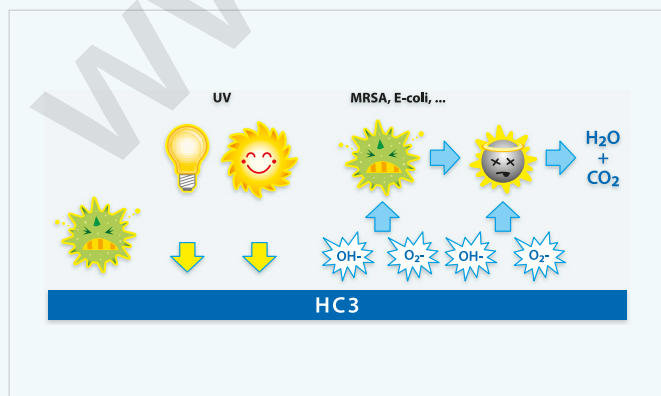

Le revêtement Antimicrobienne HC3



Un moyen de prevention supplementaire contre les bacteries nosocomiales



Caractéristiques principales du HC3

- Un effer antimicrobiel réel et rapide.
- Unique! Detruit aussi les restes des bactéries mortes.
- Autonettoyant (superhydrophile).
- Invisible. L'apparence d'acier inox reste.
- Utilisé dans divers établissements de soins depuis plus de 4 ans.
- Sans microban ou ions d'argent (technologies dépassées).

Referenties:

- Hôpital Jan Palfijn, Gand
- Hôpital, Geraardsbergen
- Centre de soins Ter Hovingen, Gand
- Ecole OLVP, Bornem
- Hôpital Saint Augustinus, Veurne
- University College Hospital, Londen
- Queens Medical Centre, Nottingham
- Al Wakra Hospital , Qatar
- Royal Pilgrim Hospital, Boston

Tous nos produits
Bâtiment utilitaire peuvent
être traités au HC3.
Plus d'informations:
www.artitec.com

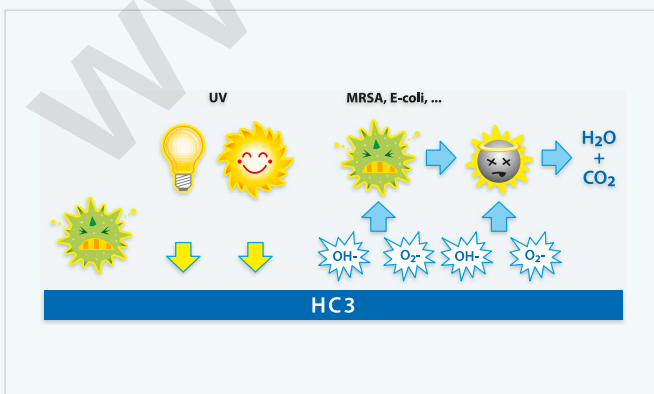

Antimikrobielle HC3-Beschichtung



Zusätzliches Mittel zur Vorbeugung gegen Krankenhausbakterien



2B

Wichtigste Eigenschaften von HC3

- Schnelle und effiziente antimikrobielle Wirkung.
- Einzigartig! Vernichtet auch die Rückstände von getöteten Bakterien.
- Selbstreinigend (Superhydrophil).
- Unsichtbar. ES-look bleibt.
- Wird bereits seit mehr als 4 Jahren in verschiedenen Gesundheitseinrichtungen verwendet.
- Enthält entweder Microban noch Silberionen (überholte Technologien).

Referenzen:

- Krankenhaus Jan Palfijn, Gent
- Krankenhaus Geraardsbergen
- Pflegezentrum Ter Hovingen, Gentbrugge
- Schule OLVP, Bornem
- Krankenhaus Sint Augustinus, Veurne
- University College Hospital, Londen
- Queens Medical Centre, Nottingham
- Al Wakra Hospital, Qatar
- Royal Pilgrim Hospital, Boston

HC3 ist verfügbar für das gesamte Objektbeschlagprogramm.
Weitere Information: www.artitec.com

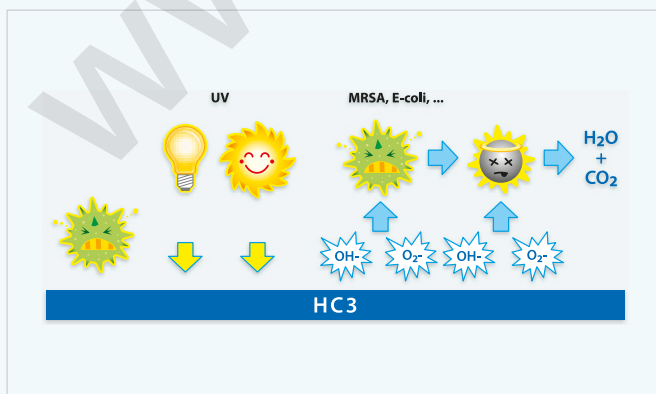

HC3 Anti-microbial coating

Additional prevention against hospital bacteria



Main HC3 properties

- Fast and effective anti-microbial effect.
- Unique! Also destroys the residue left behind by the killed bacteria.
- Self-cleaning (superhydrophilicity).
- Invisible. Stainless Steel looks stays.
- Used for more than 4 years in various care institutions.
- Does not contain Microban or silver ions (obsolete technologies).

References:

- Hospital Jan Palfijn, Gent
- Hospital, Geraardsbergen
- Care center Ter Hovingen, Gent
- School OLVP, Bornem
- Hospital Saint Augustinus, Veurne
- University College Hospital, Londen
- Queens Medical Centre, Nottingham
- Al Wakra Hospital , Qatar
- Royal Pilgrim Hospital, Boston

HC3 available for our complete commercial hardware program.
More Information:
www.artitec.com

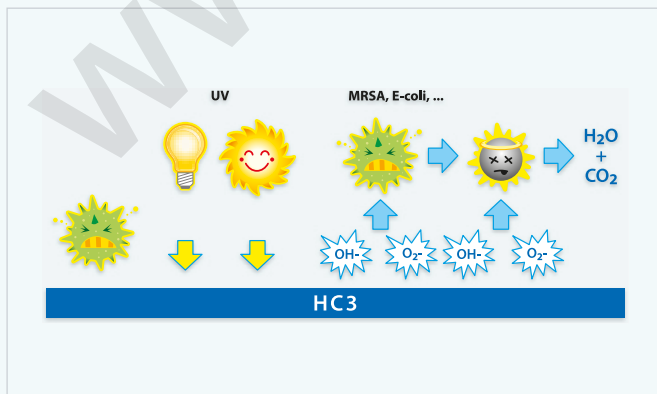

Suicide Preventie Beslag

Quincaillerie de prévention contre le suicide

2C



Oplossingen voor penitentiaire en psychiatrische instellingen

Ontworpen om opknooppunten aan het beslag te elimineren en daarmee het risico van zelftoegebracht letsel.

Maatwerk is veelvoorkomend en geen probleem. Wij gaan graag met u in gesprek om de beste oplossing voor uw project te kunnen aanbieden.

- A** De cilinder wordt bedekt door een massieve rozet. Onzichtbare bevestiging aan de bewonerzijde.
- B** Een draaibare knop is tevens anti-barricadeerbaar.
- C** Door de slipkoppeling is sleutelbediening altijd mogelijk. Ook wanneer de knop wordt vastgehouden.
- D** Aflopende en ronde vormen van grepen en krukken, waarop touw geen grip krijgt
- E** Het rvs of aluminium heeft een glad oppervlak door een speciale coating, waardoor een koord er afglijdt.
- F** Anti-suïcidaal in combinatie met HC3 is mogelijk.



Solutions pour les institutions pénitentiaires et psychiatriques.

Créer pour éliminer noeud à quincaillerie de porte et ainsi diminuer le risque de automutilation.

La personnalisation en mesure spéciale es commun et n'est pas un problème. Nous aimons engager la conversation pour offrir la meilleure solution pour votre projet.

Le cylindre est couvert par une rosette massive. Fixation invisible du côté du patient/habitant.

Un bouton (tournant) empêche toute barricade.

L'accouplement à glissement (anti-barricade) permet à tout moment la clé, même lorsque celle-ci est immobilisée intentionnellement.

Formes tombantes et arrondies des boutons et des Poignées sur lesquels les cordes n'ont pas de prise.

Un revêtement spécial fournit une surface lisse sur l'acier inoxydable et le matériel en aluminium, la prise d'une corde est réduite au minimum.

Anti-suicide en combinaison avec HC3 c'est possible.

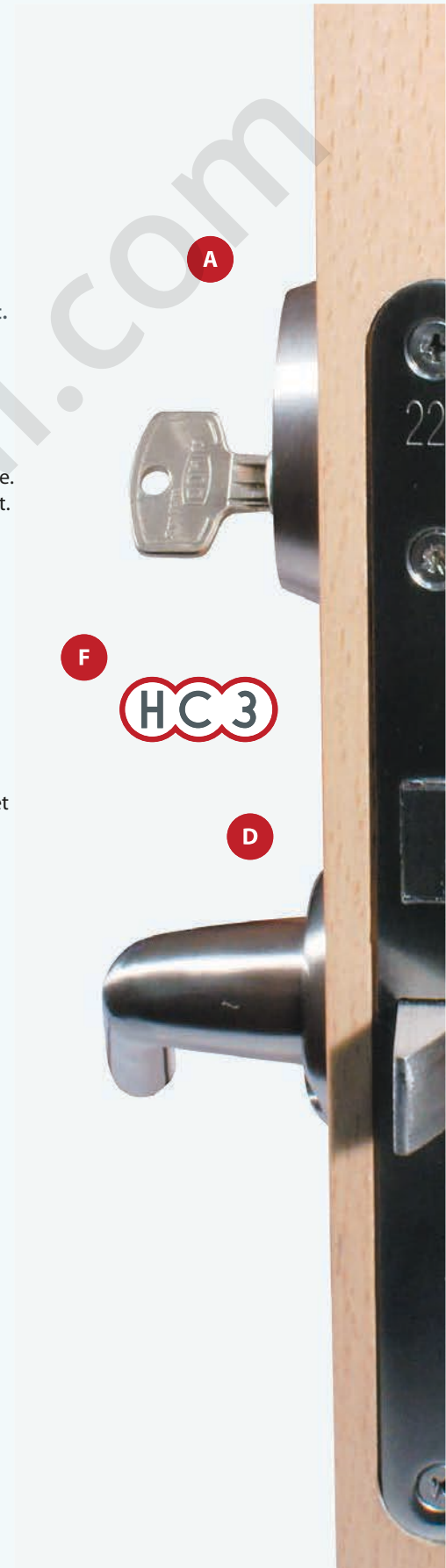

Suizid-hemmende Ausstattungen

Anti-Ligature Fittings



Lösungen für penitentiäre und psychiatrische Einrichtungen

Entworfen um Aufknüpfungspunkte an Beschläge zu eliminieren und damit das Risiko von Selbstverletzung.

Produktänderungen (Maßarbeit) sind möglich. Wir engagieren gerne mit Ihnen um die beste Lösung für Ihr Objekt anzubieten.

A

Der Zylinder wird durch eine massive Rosette abgedeckt. Unsichtbare Befestigung an der Innenseite des Patientenzimmers.

B

Ein drehbarer Knopf ist auch geeignet um Barrikaden zu vermeiden.

C

Durch die Rutschkopplung ist es immer möglich die Tür zu öffnen mit dem Schlüssel. Auch wenn man den Knopf festhält.

D

Drücker sind abfallend geformt, um das anbringen eines Seils zu vermeiden.

E

Das Edelstahl oder Aluminium hat eine glatte Oberfläche, wodurch ein Seil kein Griff hat.

F

Anti-Suizid in Kombination mit HC3 ist möglich.



Solutions for penitentiäre and psychiatric institutions.

Designed to eliminate suspension points in fittings and therefore the risk of self-injury.

Customization is common and not a problem. We like to engage ourselves in order to offer the best achievable solution for your project.

The cylinder is covered by a solid rosette. Invisible fixing on the occupants side.

The rotatable knob is also suited for anti-barrier.

The clutch has an anti-slip connection which makes it possible to turn the key even when the knob is held.

Lever and handles have special downwards bended and rounded shapes.

The Stainless steel or Aluminium has a special smooth coating, which causes ropes to slide off.

Anti-Suicide in combination with HC3 is possible.

Suicide Preventie Beslag

Quincaillerie de prévention contre le suicide

Suizid-hemmende Ausstattungen

Anti-Ligature Fittings

2A



Referenties:

- Forensisch Psychiatrisch Centrum, Gent
- Jellinek Kliniek, Amsterdam
- De Geldersche Roos, Wolfheeze
- Meander Ziekenhuis, Amersfoort
- Van der Hoevenkliniek, Amersfoort
- Diverse locaties GGZ



Références:

- Centre de psychiatrique Forensich, Gand
- Clinique Jellinek, Amsterdam
- De Geldersche Roos, Wolfheeze
- Hôpital Meander, Amersfoort
- Centre de psychiatrique Van der Hoeven, Amersfoort
- Divers endroits Soins de Santé Municipal



Referenzen:

- Forensich-Psychiatrischen Zentrum, Gent
- Jellinek Klinik, Amsterdam
- De Geldersche Roos, Wolfheeze
- Meander Krankenhaus, Amersfoort
- Van der Hoevenkliniek, Amersfoort
- Verschiedene Standorte GGZ NL



References:

- Forensic Psychiatric Centre, Gent
- Jellinek Clinic, Amsterdam
- De Geldersche Roos, Wolfheeze
- Meander Hospital, Amersfoort
- Van der Hoeven clinic, Amersfoort
- Various locations GGZ NL

Suicide preventie beslag / Quincaillerie de prévention contre le suicide Suizid-hemmende Beschlüge / Anti-ligature fittings

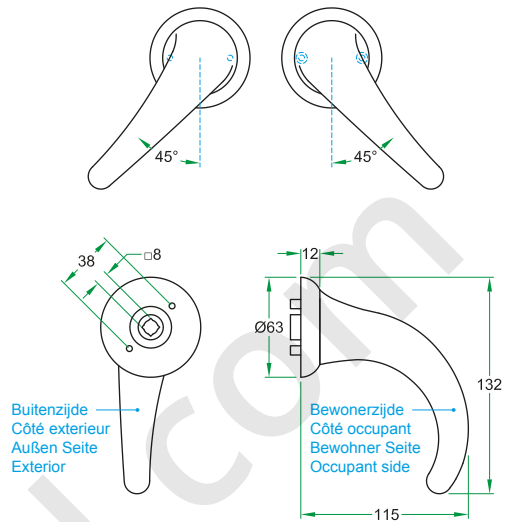

 Specificeren / Spécifier
Angeven / Specify



- Robuuste massief RVS deurkruk
- Door de vormgeving en 45° positie van de kruk is de grip van een koord tot een minimum beperkt.
- Bewonerzijde: kruk vastdraaibaar op rozet met vaste nokken M4
- Buitenzijde: kruk op rozet met doorgaande schroefbevestiging
- Leverbaar als:
Paar krukken (incl. krukstift en bevestigingsschroeven)
Als gatdeel vastdraaibaar op rozet met nokken M4
Als gatdeel op rozet met doorgaande schroefgaten



- Béquille robuste en inox massif
- La prise d'une corde est réduite au minimum par la conception e position de 45° de la béquille
- Côté occupant: béquille fixe sur rosace avec cames fixes M4
- Côté extérieur: béquille sur rosace avec fixation traversante
- Disponible en tant que:
Paire béquille (incl. tige carrée e vis de fixation)
Pièce béquille sur rosace avec cames M4
Pièce béquille sur rosace avec trous de vis



- Robuste massiv Edelstahl Türdrücker
- Durch die Form und die 45° Position der Drücker ist das Aufbringen einer Schnur begrenzt
- Bewohner Seite: Drücker festdrehbar auf Rosette mit festen Nocken M4.
- Außen Seite: Drücker auf Rosette mit durchgehender Schraubenbefestigung
- Lieferbar als:
Drückerpaar (inschl. Vierkantstift und Befestigungsschrauben)
Lochteil festdrehbar auf Rosette mit Nocken M4
Lochteil auf Rosette mit durchgehenden Schraubenlöchern



- Robust solid stainless steel lever
- The shape and 45° position of the lever limits the attachment of a ligature
- Occupant side: lever fixed on rose with lugs M4
- Exterior side: lever on rose with bolt-through screw holes
- Available as:
Pair levers (incl. square spindle and fixing material)
Single lever fixed on rose with lugs M4
Single lever on rose with bolt-through screw holes

Specificeren / Preciser / Angeven / Specify

	Bewoner zijde / Côté occupant Bewohner Seite / Occupant side			Bewoner zijde / Côté occupant Bewohner Seite / Occupant side			Buitenzijde / Côté extérieur Außen Seite / Exterior side	
		94100PL Links / Gauche Links / Left			94101 Links / Gauche Links / Left			94103 Links / Gauche Links / Left
		94100PR Rechts / Droit Rechts / Right			94102 Rechts / Droit Rechts / Right			94104 Rechts / Droit Rechts / Right

Informeer naar onze separate brochure 'Zorg & Welzijn' voor uitgebreider assortiment en verdere toepassingen.
Pour plus d'informations consultez notre brochure 'Soins & Bien-être' avec un assortiment plus détaillé et les applications plus avants.
Für weitere Informationen fordern Sie bitte unsere Broschüre 'Pflege & Wohl' an, die das gesamte Sortiment und weitere Anwendungen beinhaltet.
For more information request our separate brochure 'Care & Welfare' for a wider assortment and other applications.

Suicide preventie beslag / Quincaillerie de prévention contre le suicide Suizid-hemmende Beschlüge / Anti-ligature fittings

2C

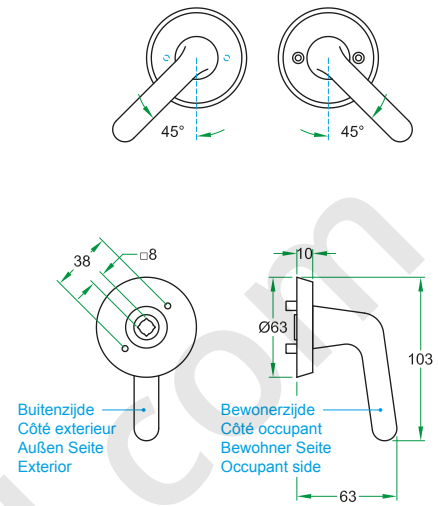

Specificeren / Spécifier
Angeben / Specify



- Massief RVS deurkruk op rozet Ø63 mm
- Door de vormgeving en 45° positie van de kruk is de grip van een koord tot een minimum beperkt.
- Bewonerzijde: kruk vastdraaibaar op rozet met vaste nokken M4
- Buitenzijde: kruk op rozet met doorgaande schroefbevestiging
- Leverbaar als:
Paar krukken (incl. krukstift en bevestigingsschroeven)
Als gatdeel vastdraaibaar op rozet met nokken M4
Als gatdeel op rozet met doorgaande schroefgaten
Ook leverbaar in massief aluminium



- Béquille en inox massif sur rosace Ø63 mm
- La prise d'une corde est réduite au minimum grâce à la conception et position de 45° de la béquille
- Côté occupant: béquille fixe sur rosace avec came fixes M4
- Côté extérieur: béquille sur rosace avec fixation traversante
- Disponible en tant que:
Paire béquille (incl. tige carrée et vis de fixation)
Pièce béquille sur rosace avec came M4
Pièce béquille sur rosace avec trous de vis
Aussi disponible en aluminium massif



- Massif Edelstahl Türdrücker auf Rosette Ø63 mm
- Durch die Form und die 45° Position der Drücker ist das Aufbringen einer Schnur begrenzt
- Bewohner Seite: Drücker festdrehbar auf Rosette mit festen Nocken M4.
- Außen Seite: Drücker auf Rosette mit durchgehender Schraubenbefestigung
- Lieferbar als:
Drückerpaar (einschl. Vierkantstift und Befestigungsschrauben)
Lochteil festdrehbar auf Rosette mit Nocken M4
Lochteil auf Rosette mit durchgehenden Schraubenlöchern
Auch lieferbar in massiv Aluminium



- Solid stainless steel lever on rose Ø63 mm
- The shape and 45° position of the lever limits the attachment of a ligature
- Occupant side: lever fixed on rose with lugs M4
- Exterior side: lever on rose with bolt-through screw holes
- Available as:
Pair levers (incl. square spindle and fixing material)
Single lever fixed on rose with lugs M4
Single lever on rose with bolt-through screw holes
Also available in solid aluminium

Specificeren / Preciser / Angeben / Specify

Bewoner zijde / Côté occupant Bewohner Seite / Occupant side		Bewoner zijde / Côté occupant Bewohner Seite / Occupant side		Buitenzijde / Côté extérieur Außen Seite / Exterior side	
	94120PL Links / Gauche Links / Left		94121 Links / Gauche Links / Left		94123 Links / Gauche Links / Left
	94120PR Rechts / Droit Rechts / Right		94122 Rechts / Droit Rechts / Right		94124 Rechts / Droit Rechts / Right

Informeer naar onze separate brochure 'Zorg & Welzijn' voor uitgebreider assortiment en verdere toepassingen.
Pour plus d'informations consultez notre brochure 'Soins & Bien-être' avec un assortiment plus détaillé et les applications plus avants.
Für weitere Informationen fordern Sie bitte unsere Broschüre 'Pflege & Wohl' an, die das gesamte Sortiment und weitere Anwendungen beinhaltet.
For more information request our separate brochure 'Care & Welfare' for a wider assortment and other applications.

Suicide preventie beslag / Quincaillerie de prévention contre le suicide Suizid-hemmende Beschlüge / Anti-ligature fittings

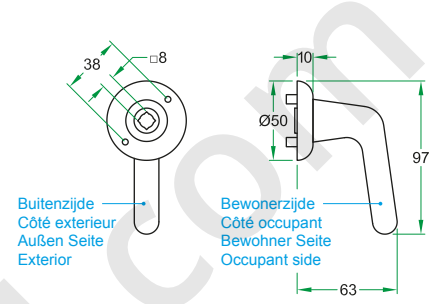
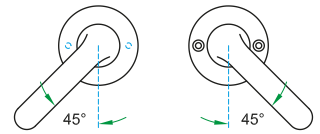

Specificeren / Spécifier
Angeven / Specify



- Massief RVS deurkruk op rozet Ø50 mm
- Door de vormgeving en 45° positie van de kruk is de grip van een koord tot een minimum beperkt.
- Bewonerzijde: kruk vastdraaibaar op rozet met vaste nokken M4
- Buitenzijde: kruk op rozet met doorgaande schroefbevestiging
- Leverbaar als:
Paar krukken (incl. krukstift en bevestigingsschroeven)
Als gatdeel vastdraaibaar op rozet met nokken M4
Als gatdeel op rozet met doorgaande schroefgaten
Ook leverbaar in massief aluminium



- Béquille en inox massif sur rosace Ø50 mm
- La prise d'une corde est réduite au minimum grâce à la conception et position de 45° de la béquille
- Côté occupant: béquille fixe sur rosace avec cames fixes M4
- Côté extérieur: béquille sur rosace avec fixation traversante
- Disponible en tant que:
Paire béquille (incl. tige carrée et vis de fixation)
Pièce béquille sur rosace avec cames M4
Pièce béquille sur rosace avec trous de vis
Aussi disponible en aluminium massif



- Massif Edelstahl Türdrücker auf Rosette Ø50 mm
- Durch die Form und die 45° Position der Drücker ist das Aufbringen einer Schnur begrenzt
- Bewohner Seite: Drücker festdrehbar auf Rosette mit festen Nocken M4.
- Außen Seite: Drücker auf Rosette mit durchgehender Schraubenbefestigung
- Lieferbar als:
Drückerpaar (einschl. Vierkantstift und Befestigungsschrauben)
Lochteil festdrehbar auf Rosette mit Nocken M4
Lochteil auf Rosette mit durchgehenden Schraubenlöchern
Auch lieferbar in massiv Aluminium



- Solid stainless steel lever on rose Ø50 mm
- The shape and 45° position of the lever limits the attachment of a ligature
- Occupant side: lever fixed on rose with lugs M4
- Exterior side: lever on rose with bolt-through screw holes
- Available as:
Pair levers (incl. square spindle and fixing material)
Single lever fixed on rose with lugs M4
Single lever on rose with bolt-through screw holes
Also available in solid aluminium

Specificeren / Preciser / Angeven / Specify

Bewoner zijde / Côté occupant Bewohner Seite / Occupant side		Bewoner zijde / Côté occupant Bewohner Seite / Occupant side		Buitenzijde / Côté extérieur Außen Seite / Exterior side	
	94110PL Links / Gauche Links / Left		94111 Links / Gauche Links / Left		94113 Links / Gauche Links / Left
	94110PR Rechts / Droit Rechts / Right		94112 Rechts / Droit Rechts / Right		94114 Rechts / Droit Rechts / Right

Informeer naar onze separate brochure 'Zorg & Welzijn' voor uitgebreider assortiment en verdere toepassingen.
Pour plus d'informations consultez notre brochure 'Soins & Bien-être' avec un assortiment plus détaillé et les applications plus avants.
Für weitere Informationen fordern Sie bitte unsere Broschüre 'Pflege & Wohl' an, die das gesamte Sortiment und weitere Anwendungen beinhaltet.
For more information request our separate brochure 'Care & Welfare' for a wider assortment and other applications.

Suicide preventie beslag / Quincaillerie de prévention contre le suicide Suizid-hemmende Beschlüge / Anti-ligature fittings

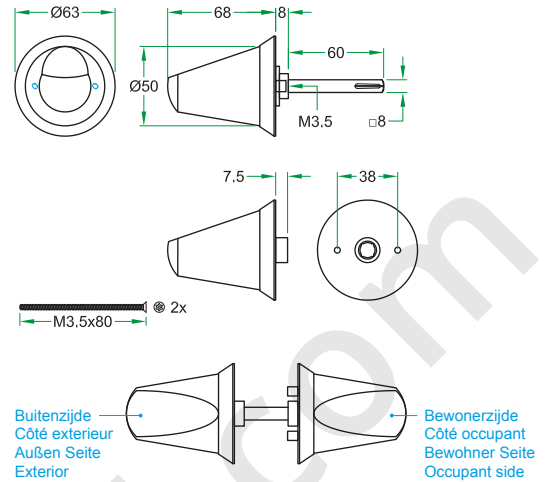

Specificeren / Spécifier
Angeven / Specify



- Massief RVS knop Ø50 mm op rozet Ø63 mm
- Door de schuine vormgeving van de knop is de grip van een koord tot een minimum beperkt
- Bewonerzijde: knop vastdraaibaar op rozet met vaste nokken M4
- Buitenzijde: knop op rozet met doorgaande schroefbevestiging
- Leverbaar als:
Paar knoppen (incl. krukstift en bevestigingsschroeven)
Per stuk vastdraaibaar op rozet met nokken M4
Per stuk op rozet met doorgaande schroefgaten
Ook leverbaar in massief aluminium



- Bouton en inox massif Ø50 mm sur rosace Ø63 mm
- La prise d'une corde est réduite au minimum grâce à la conception du bouton
- Côté occupant: bouton fixe sur rosace avec cames fixes M4
- Côté extérieur: bouton sur rosace avec fixation traversante
- Disponible en tant que:
Paire bouton (incl. tige carrée e vis de fixation)
Pièce bouton sur rosace avec cames M4
Pièce bouton sur rosace avec trous de vis
Aussi disponible en aluminium massif



- Massif Edelstahl Knopf Ø50 mm auf Rosette Ø63 mm
- Durch die schräge Form der Knopf ist das Aufbringen einer Schnur begrenzt
- Bewohner Seite: Knopf festdrehbar auf Rosette mit festen Nocken M4
- Außen Seite: Knopf auf Rosette mit durchgehender Schraubenbefestigung
- Lieferbar als:
Knopfpaar (einschl. Vierkantstift und Befestigungsschrauben)
Stück festdrehbar auf Rosette mit Nocken M4
Stück auf Rosette mit durchgehenden Schraubenlöchern
Auch lieferbar in massiv Aluminium



- Solid stainless steel knob Ø50 mm on rose Ø63 mm
- The oblique shape of the knob limits the attachment of a ligature
- Occupant side: knob fixed on rose with lugs M4
- Exterior side: knob on rose with bolt-through screw holes
- Available as:
Pair knobs (incl. square spindle and fixing material)
Single knob fixed on rose with lugs M4
Single knob on rose with bolt-through screw holes
Also available in solid aluminium

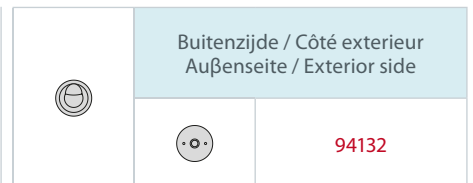

Informeer naar onze separate brochure 'Zorg & Welzijn' voor uitgebreider assortiment en verdere toepassingen.
Pour plus d'informations consultez notre brochure 'Soins & Bien-être' avec un assortiment plus détaillé et les applications plus avants.
Für weitere Informationen fordern Sie bitte unsere Broschüre 'Pflege & Wohl' an, die das gesamte Sortiment und weitere Anwendungen beinhaltet.
For more information request our separate brochure 'Care & Welfare' for a wider assortment and other applications.

Suicide preventie beslag / Quincaillerie de prévention contre le suicide Suizid-hemmende Beschlüge / Anti-ligature fittings

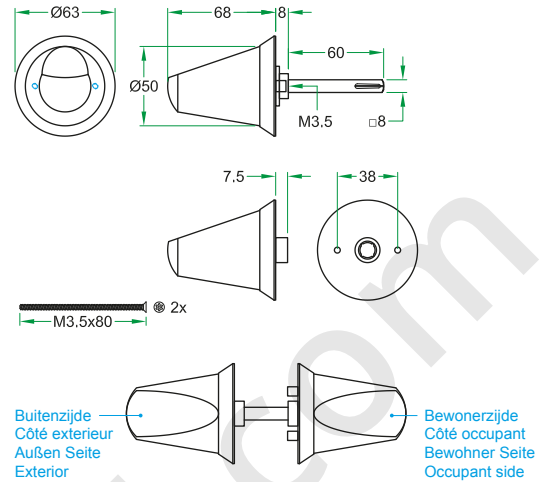

Specificeren / Spécifier
Angeven / Specify



- Massief RVS knop Ø50 mm op rozet Ø63 mm
- Door de schuine vormgeving van de knop is de grip van een koord tot een minimum beperkt
- Bewonerzijde: knop vastdraaibaar op rozet met vaste nokken M4
- Buitenzijde: knop op rozet met doorgaande schroefbevestiging
- Leverbaar als:
Paar knoppen (incl. krukstift en bevestigingsschroeven)
Per stuk vastdraaibaar op rozet met nokken M4
Per stuk op rozet met doorgaande schroefgaten
Ook leverbaar in massief aluminium



- Bouton en inox massif Ø50 mm sur rosace Ø63 mm
- La prise d'une corde est réduite au minimum grâce à la conception du bouton
- Côté occupant: bouton fixe sur rosace avec cames fixes M4
- Côté extérieur: bouton sur rosace avec fixation traversante
- Disponible en tant que:
Paire bouton (incl. tige carrée e vis de fixation)
Pièce bouton sur rosace avec cames M4
Pièce bouton sur rosace avec trous de vis
Aussi disponible en aluminium massif



- Massif Edelstahl Knopf Ø50 mm auf Rosette Ø63 mm
- Durch die schräge Form der Knopf ist das Aufbringen einer Schnur begrenzt
- Bewohner Seite: Knopf festdrehbar auf Rosette mit festen Nocken M4
- Außen Seite: Knopf auf Rosette mit durchgehender Schraubenbefestigung
- Lieferbar als:
Knopfpaar (einschl. Vierkantstift und Befestigungsschrauben)
Stück festdrehbar auf Rosette mit Nocken M4
Stück auf Rosette mit durchgehenden Schraubenlöchern
Auch lieferbar in massiv Aluminium



- Solid stainless steel knob Ø50 mm on rose Ø63 mm
- The oblique shape of the knob limits the attachment of a ligature
- Occupant side: knob fixed on rose with lugs M4
- Exterior side: knob on rose with bolt-through screw holes
- Available as:
Pair knobs (incl. square spindle and fixing material)
Single knob fixed on rose with lugs M4
Single knob on rose with bolt-through screw holes
Also available in solid aluminium

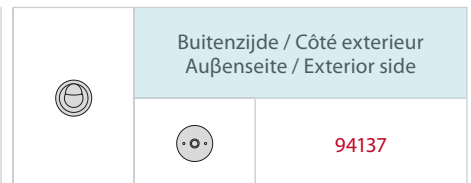

Informeer naar onze separate brochure 'Zorg & Welzijn' voor uitgebreider assortiment en verdere toepassingen.
Pour plus d'informations consultez notre brochure 'Soins & Bien-être' avec un assortiment plus détaillé et les applications plus avants.
Für weitere Informationen fordern Sie bitte unsere Broschüre 'Pflege & Wohl' an, die das gesamte Sortiment und weitere Anwendungen beinhaltet.
For more information request our separate brochure 'Care & Welfare' for a wider assortment and other applications.

Suicide preventie beslag / Quincaillerie de prévention contre le suicide Suizid-hemmende Beschlüge / Anti-ligature fittings

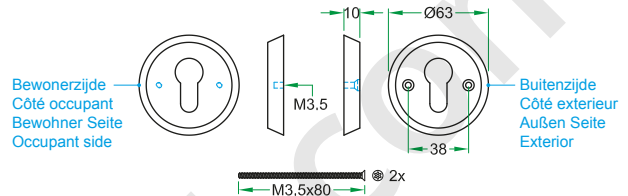
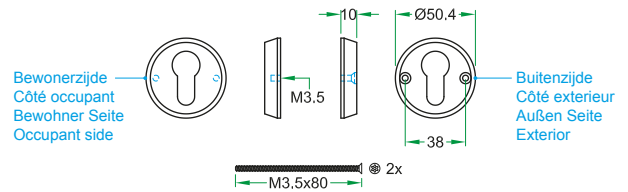

Specificeren / Spécifier
Angeben / Specify



- Massief RVS profiel cilinder rozetten
- Door de schuine rand van de rozet is de grip van een koord tot een minimum beperkt.
- Leverbaar als:
Paar rozetten (incl. bevestigingsschroeven)
Per stuk met ontvangende schroefgaten (bewonerzijde)
Per stuk met doorgaande schroefgaten (buitenzijde)



- Rosaces pour cylindre profil en inox massif
- La prise d'une corde est réduite au minimum grâce au bord incliné de la rosace
- Disponible en tant que:
Paire rosaces (incl. vis de fixation)
Pièce avec trous de réception (côté occupant)
Pièce avec trous traversants (côté extérieur)



- Massif Edelstahl Profilylinderrosetten
- Durch die absteigende Rand der Rosette ist das Aufbringen einer Schnur begrenzt
- Lieferbar als:
Paar Rosetten (einschl. Befestigungsschrauben)
Stück mit Aufnahmelöcher (Bewohnerseite)
Stück mit durchgehende Löcher (Außenseite)



- Solid stainless steel profile cylinder roses
- The sloping design of the rose limits the attachment of a ligature
- Available as:
Pair roses (incl. fixing screws)
Piece with receiving holes (occupant side)
Piece with bolt-through holes (exterior side)

Rozet / Rosace / Rosette / Rose Ø 50 mm

		94160
		Bewoner zijde / Côté occupant Bewohner Seite / Occupant side
		94162PS
		94163PS
		Buitenzijde / Côté extérieur Außenseite / Exterior side
		94162ES
		94163ES

Rozet / Rosace / Rosette / Rose Ø 63 mm

		94165
		Bewoner zijde / Côté occupant Bewohner Seite / Occupant side
		94167PS
		94168PS
		Buitenzijde / Côté extérieur Außenseite / Exterior side
		94172ES
		94183ES

Informeer naar onze separate brochure 'Zorg & Welzijn' voor uitgebreider assortiment en verdere toepassingen.

Pour plus d'informations consultez notre brochure 'Soins & Bien-être' avec un assortiment plus détaillé et les applications plus avants.

Für weitere Informationen fordern Sie bitte unsere Broschüre 'Pflege & Wohl' an, die das gesamte Sortiment und weitere Anwendungen beinhaltet.

For more information request our separate brochure 'Care & Welfare' for a wider assortment and other applications.

Suicide preventie beslag / Quincaillerie de prévention contre le suicide Suizid-hemmende Beschlüge / Anti-ligature fittings

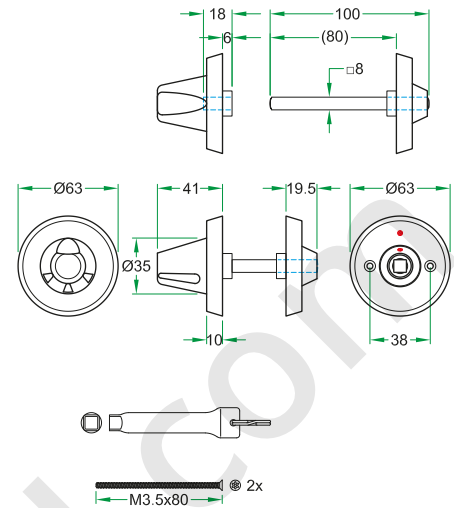

Specificeren / Spécifier
Angeven / Specify



- Massief RVS toiletsluiting met noodontgrendeling en slipkoppeling t.b.v. anti-barricade, incl. sleutel.
- Door de schuine vormgeving van de WC knop en rozet is de grip van een koord tot een minimum beperkt.
- Wordt als paar geleverd, incl. bevestigingsschroeven
- Knoprozet met ontvangende schroefgaten (bewonerzijde)
- Rozet met noodontgrendeling met doorgaande schroefgaten (buitenzijde)



- Fermeture de toilette en inox massif avec déverrouillage d'urgence e accouplement mécanique de sécurité
- Comprend la clé pour ouvrir
- La prise d'une corde est réduite au minimum grâce à la conception du bouton e du bord incliné de la rosace
- Comme paire, incl. vis de fixation
- Rosace avec bouton avec trous de réception (côté occupant)
- Rosace avec déverrouillage d'urgence avec trous traversantes (côté extérieur)



- Massif Edelstahl Badrosetten mit Notentriegelung und Rutsch-Kupplung gegen Verbarrikadierung
- Einschl. Schlüssel für Notentriegelung.
- Durch den Knopfform und die absteigende Rand der Rosette ist das Aufbringen einer Schnur begrenzt
- Wird geliefert als Paar, einschl. Befestigungsschrauben
- Paar Rosetten (einschl. Befestigungsschrauben)
- Knopfrosette mit Aufnahmelöcher (Bewohnerseite)
- Rosette mit Notentriegelung mit durchgehende Löcher (Außenseite)



- Solid stainless steel bathroom set with emergency release and clutch to prevent barricading.
- Incl. key for emergency release.
- The knob design and the sloping design of the rose limits the attachment of a ligature
- Supplied as pair, incl. fixing screws
- Knob rose with receiving holes (occupant side)
- Rose with emergency release with bolt-through holes (exterior side)

	94175
	94171

Informeer naar onze separate brochure 'Zorg & Welzijn' voor uitgebreider assortiment en verdere toepassingen.
Pour plus d'informations consultez notre brochure 'Soins & Bien-être' avec un assortiment plus détaillé et les applications plus avants.
Für weitere Informationen fordern Sie bitte unsere Broschüre 'Pflege & Wohl' an, die das gesamte Sortiment und weitere Anwendungen beinhaltet.
For more information request our separate brochure 'Care & Welfare' for a wider assortment and other applications.

Suicide preventie beslag / Quincaillerie de prévention contre le suicide Suizid-hemmende Beschlüge / Anti-ligature fittings

2C



- Massief rvs deurgreep
- met voldoende grip om grotere deuren, voorzien van deurdrangers, te openen
- Door de vormgeving is de grip van een koord of touw tot een minimum beperkt
- Voorzien van speciale veiligheidsschroeven
- Per stuk met enkelzijdige schroefbevestiging
- Per paar met doorgaande schroefbevestiging
- Ook leverbaar in aluminium



- Le tirant en inox massif a été conçu afin d'offrir assez de prise pour ouvrir de grandes portes équipées de ferme-porte
- Grâce à la conception aucune possibilité d'y attacher une corde
- Livré avec des vis spéciales de sécurité
- Pièce avec fixation sur un côté
- Paire avec fixation traversante
- Aussi disponible en aluminium



- Massiv Edelstahl Türgriff mit ausreichender Griff-Fläche um schwere Türen mit einem Türschließer öffnen zu können
- Durch die Form ist das Aufbringen einer Schnur begrenzt
- Ausgestattet mit Sicherheits-Schrauben
- Stück mit einseitiger Befestigung
- Paar mit durchgehender Befestigung
- Auch lieferbar in Aluminium



- Solid stainless steel pull handle with sufficient grip to open larger doors with doorcloser
- The shape limits the attachment of a ligature
- Fitted with security screws
- Piece with face-fixed screws
- Pair with bolt through fixing screws
- Also available in aluminium

St. / Pc.	94220
Paar / Pair	94221

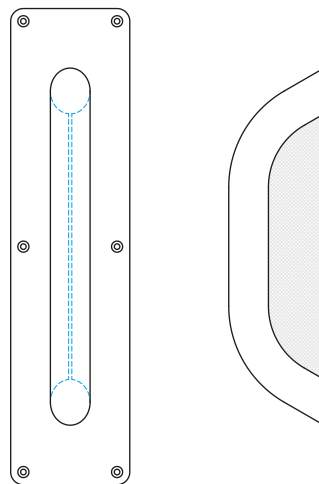
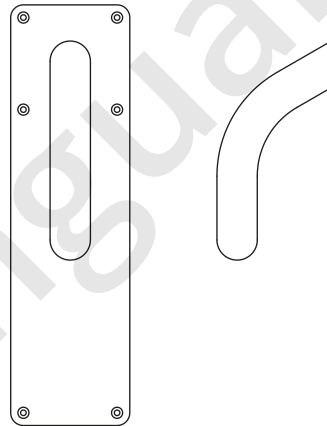

Afwijkende schildlengte mogelijk
Adaption de la plaque possible
Abweichende Schildlänge möglich
Different plate lengths possible

St. / Pc.	94215
Paar / Pair	94216

Informeer naar onze separate brochure 'Zorg & Welzijn' voor uitgebreider assortiment en verdere toepassingen.
Pour plus d'informations consultez notre brochure 'Soins & Bien-être' avec un assortiment plus détaillé et les applications plus avants.
Für weitere Informationen fordern Sie bitte unsere Broschüre 'Pflege & Wohl' an, die das gesamte Sortiment und weitere Anwendungen beinhaltet.
For more information request our separate brochure 'Care & Welfare' for a wider assortment and other applications.

Suicide preventie beslag / Quincaillerie de prévention contre le suicide Suizid-hemmende Beschlüge / Anti-ligature fittings



- Massief RVS deurgreep
- met voldoende grip om grotere deuren, voorzien van deurdrangers, te openen
- Door de vormgeving is de grip van een koord of touw tot een minimum beperkt
- Incl. speciale veiligheidsschroeven
- Ook leverbaar in aluminium



- Le tirant en inox massif a été conçue afin d'offrir assez de prise pour ouvrir de grandes portes équipées de ferme-porte
- Grâce à la conception aucune possibilité d'y attacher une corde
- Incl. vis spéciales de sécurité
- Aussi disponible en aluminium



- Massiv Edelstahl Türgriff mit ausreichender Griff-Fläche um schwere Türen mit einem Türschließer öffnen zu können
- Durch die Form ist das Aufbringen einer Schnur begrenzt
- Ausgestattet mit einseitiger Sicherheits-Schrauben
- Auch lieferbar in Aluminium



- Solid stainless steel pull handle with sufficient grip to open larger doors with doorcloser
- The shape limits the attachment of a ligature
- Included face-fixed security screws
- Also available in aluminium

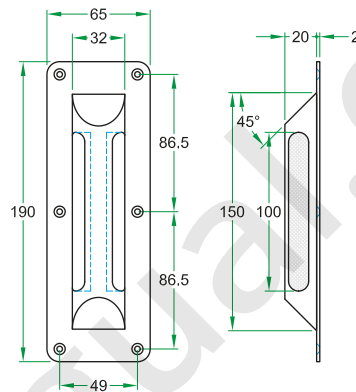

St. / Pc.

94225



- Massief aluminium deurgreep
- met voldoende grip om grotere deuren, voorzien van deurdrangers, te openen
- Door de vormgeving is de grip van een koord of touw tot een minimum beperkt
- Incl. speciale veiligheidsschroeven



- Le tirant en aluminium massif a été conçue afin d'offrir assez de prise pour ouvrir de grandes portes équipées de ferme-porte
- Grâce à la conception aucune possibilité d'y attacher une corde
- Livré avec des vis spéciales de sécurité.



- Massiv Aluminium Türgriff mit ausreichender Griff-Fläche um schwere Türen mit einem Türschließer öffnen zu können
- Durch die Form ist das Aufbringen einer Schnur begrenzt
- Ausgestattet mit Sicherheits-Schrauben



- Solid aluminium pull handle with sufficient grip to open larger doors with doorcloser
- The shape limits the attachment of a ligature
- Fitted with face-fixed security screws

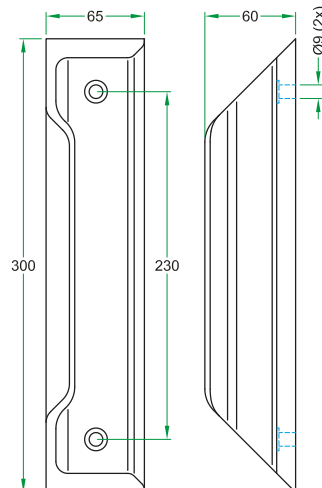

St. / Pc.

94205

Informeer naar onze separate brochure 'Zorg & Welzijn' voor uitgebreider assortiment en verdere toepassingen.
Pour plus d'informations consultez notre brochure 'Soins & Bien-être' avec un assortiment plus détaillé et les applications plus avants.
Für weitere Informationen fordern Sie bitte unsere Broschüre 'Pflege & Wohl' an, die das gesamte Sortiment und weitere Anwendungen beinhaltet.
For more information request our separate brochure 'Care & Welfare' for a wider assortment and other applications.

Suicide preventie beslag / Quincaillerie de prévention contre le suicide Suizid-hemmende Beschlage / Anti-ligature fittings

2C



St. / Pc. 94230



- Massief RVS ovale deurgreep vastgemonteerd op ovaal schild
- Door de vormgeving is de grip van een koord of touw tot een minimum beperkt
- Incl. speciale enkelzijdige veiligheidsschroeven



- Tirant ovale en inox massif monté sur plaque ovale
- Grâce à la conception aucune possibilité d'y attacher une corde
- Livré avec des vis spéciales de sécurité



- Massiv Edelstahl ovaler Türgriff festmontiert auf ovalen Schild
- Durch die Form ist das Aufbringen einer Schnur begrenzt
- Ausgestattet mit einseitiger Sicherheits-Schrauben



- Solid stainless oval pull handle on oval plate
- The shape limits the attachment of a ligature
- Fitted with face-fixed security screws

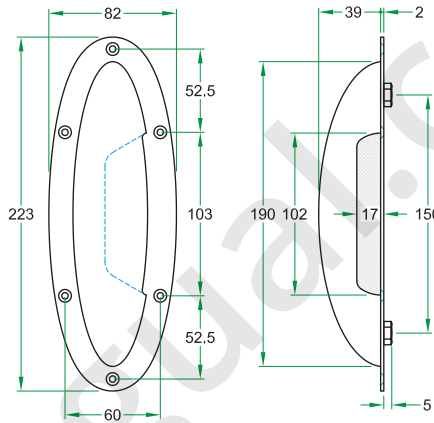

- Massief RVS komgreep, binnenzijde afgerond.
- Montage horizontaal of verticaal
- Door de vormgeving is de grip van een koord of touw tot een minimum beperkt
- Incl. speciale veiligheidsschroeven
- Ook leverbaar in aluminium (komgreep is dan echter a-gecentreerd)



- Cuvette en inox massif, la partie intérieure est arrondie
- Montage horizontal ou vertical
- Grâce à la conception, aucune possibilité d'y attacher une corde
- Livré avec des vis spéciales de sécurité
- Aussi disponible en aluminium (la partie intérieure sera cependant a-centrée)



- Massiv Edelstahl Muschelgriff, Innenseite ist abgerundet
- Montage horizontal oder vertikal
- Durch die Form ist das Aufbringen einer Schnur begrenzt
- Ausgestattet mit Sicherheits-Schrauben
- Auch lieferbar in Aluminium (in diesem Fall ist der Griff a-zentriert)



- Solid stainless pull, rounded interior
- Horizontal or vertical mounting
- The shape limits the attachment of a ligature
- Fitted with face-fixed security screws
- Also available in aluminium (in this case the handle grip is off-centered)



St. / Pc. 94235

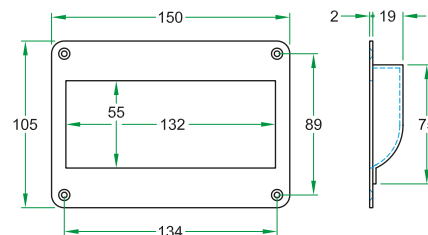

Informeer naar onze separate brochure 'Zorg & Welzijn' voor uitgebreider assortiment en verdere toepassingen.
Pour plus d'informations consultez notre brochure 'Soins & Bien-être' avec un assortiment plus détaillé et les applications plus avants.
Für weitere Informationen fordern Sie bitte unsere Broschüre 'Pflege & Wohl' an, die das gesamte Sortiment und weitere Anwendungen beinhaltet.
For more information request our separate brochure 'Care & Welfare' for a wider assortment and other applications.

Suicide preventie beslag / Quincaillerie de prévention contre le suicide Suizid-hemmende Beschlüge / Anti-ligature fittings

2C



- Massief RVS knop Ø50 mm op schild
- De vormgeving van de knop beperkt de grip van een koord tot een minimum
- Per paar incl. speciale veiligheidsschroeven
- Optioneel met profiel cylinder gat



- Bouton en inox massif Ø50 mm sur plaque
- La prise d'une corde est réduite au minimum grâce à la conception du bouton
- Paire, livré avec des vis spéciales de sécurité
- Optionnel avec trou de cylindre profil



- Massiv Edelstahl Knopf Ø50 mm auf Schild
- Durch die Form ist das Aufbringen einer Schnur begrenzt
- Paarweise einschl. Sicherheits-Schrauben
- Mit Profil Zylinder Lochung möglich



- Solid stainless steel knob Ø50 mm on plate
- The shape limits the attachment of a ligature
- Paire with back-to-back security fixing
- Profile cylinder hole optional

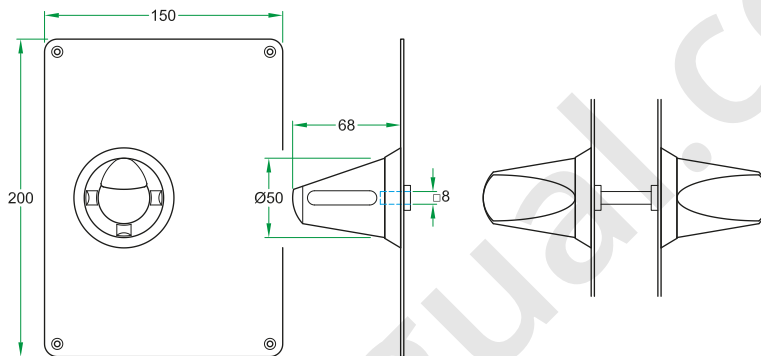

Afwijkende schildlengte mogelijk
Adaption de la plaque possible
Abweichende Schildlänge möglich
Different plate lengths possible

Paar / Pair **94140**



- Massief RVS kogelscharnier
- Speciaal afgevlakt anti-afbind scharnier met afgeschermd scharnierbevestiging voor extra veiligheid
- Beperkt de grip van een koord of touw tot een minimum



- Charnière en inox massif
- Charnière spéciale biseautée avec fixation protégée pour une sécurité supplémentaire
- Grâce à cette conception, aucune possibilité d'y attacher une corde



- Massiv Edelstahl kugelgelagertes Band
- Speziell abgeflachtes Band mit Schutzbefestigung für zusätzliche Sicherheit
- Das Aufbringen einer Schnur ist begrenzt



- Solid stainless steel ball bearing hinge
- Special chamfered anti-ligature hinge with covered hinge fastener for extra security ,
- Limits the attachment of a ligature

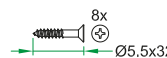
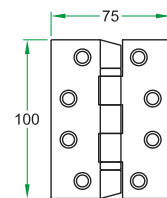

St. / Pc. **94280**

Informeer naar onze separate brochure 'Zorg & Welzijn' voor uitgebreider assortiment en verdere toepassingen.
Pour plus d'informations consultez notre brochure 'Soins & Bien-être' avec un assortiment plus détaillé et les applications plus avants.
Für weitere Informationen fordern Sie bitte unsere Broschüre 'Pflege & Wohl' an, die das gesamte Sortiment und weitere Anwendungen beinhaltet.
For more information request our separate brochure 'Care & Welfare' for a wider assortment and other applications.

Suicide preventie beslag / Quincaillerie de prévention contre le suicide Suizid-hemmende Beschlüge / Anti-ligature fittings

2C



- Massief aluminium raamgreep
- Door de vormgeving is de grip van een koord tot een minimum beperkt
- Incl. speciale veiligheidsschroeven



- Poignée de fenêtre en aluminium massif
- Grâce à la conception, aucune possibilité d'y attacher une corde
- Livré avec des vis spéciales de sécurité



- Massiv Aluminium Fenstergriff
- Durch die Form ist das Aufbringen einer Schnur begrenzt
- Ausgestattet mit Sicherheits-Schrauben



- Solid aluminium window pull
- The shape limits the attachment of a ligature
- Fitted with special security screws

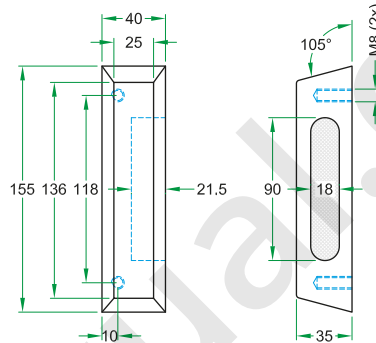

St. / Pc.

94250



- Massief rvs raamkruk met afneembare greep
- Geen mogelijkheid voor bevestiging van koord
- Incl. speciale veiligheidsschroeven



- Béquille de fenêtre en inox massif avec poignée amovible
- Aucune possibilité d'y attacher une corde
- Livré avec des vis spéciales de sécurité



- Massiv Edelstahl Fenstergriff; Griff läßt sich entfernen
- Keine Möglichkeit eine Schnur zu befestigen
- Ausgestattet mit Sicherheits-Schrauben



- Solid stainless steel window lever; lever can be removed
- No possibility to attach a cord
- Fitted with special security screws

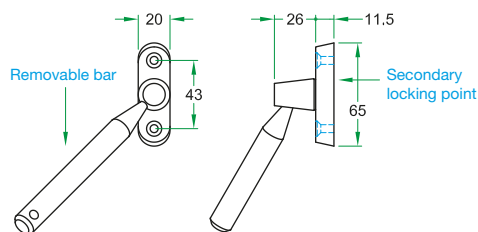

St. / Pc.

94260

Informeer naar onze separate brochure 'Zorg & Welzijn' voor uitgebreider assortiment en verdere toepassingen.
Pour plus d'informations consultez notre brochure 'Soins & Bien-être' avec un assortiment plus détaillé et les applications plus avants.
Für weitere Informationen fordern Sie bitte unsere Broschüre 'Pflege & Wohl' an, die das gesamte Sortiment und weitere Anwendungen beinhaltet.
For more information request our separate brochure 'Care & Welfare' for a wider assortment and other applications.

Suicide preventie beslag / Quincaillerie de prévention contre le suicide Suizid-hemmende Beschlüge / Anti-ligature fittings



- Massief RVS jashaak geschikt voor lichte kledingstukken
- Bij grotere belasting zakt haakje weg
- Maximum gewicht is instelbaar
- Geen mogelijkheid voor bevestiging van koord of touw



- Crochet en inox massif pour vêtements légers
- En cas de une plus grande charge, le crochet tombe
- Le poids maximum est réglable
- Grâce à cette conception, aucune possibilité d'y attacher une corde



- Massiv Edelstahl Mantelhaken geeignet für leichte Kleider
- Bei größerer Belastung, fällt der Haken nach unten
- Maximales Gewicht ist verstellbar
- Keine Möglichkeit eine Schnur zu befestigen



- Solid stainless steel coat hook for light-weight garments
- The ball joint hook will collapse under higher weight pressure
- Maximum weight is adjustable
- No possibility to attach a rope or wire

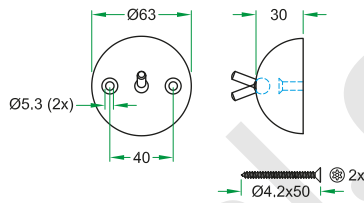

94270



- Flexibele kunststof jashaak
- Buigt onder groter gewicht
- Geschikt voor laag-risico situaties



- Patère souple en plastique
- Se plie sous le poids plus haut
- Apte pour situations peu risquées



- Flexibeler Kunststoff Mantelhaken
- Biegt unten größerer Belastung
- Geeignet für Niedrig-Risiko-Situationen



- Flexible plastic coat hook
- Bents under heavier weight
- Suitable for low-risk situations



94272

Informeer naar onze separate brochure 'Zorg & Welzijn' voor uitgebreider assortiment en verdere toepassingen.
Pour plus d'informations consultez notre brochure 'Soins & Bien-être' avec un assortiment plus détaillé et les applications plus avants.
Für weitere Informationen fordern Sie bitte unsere Broschüre 'Pflege & Wohl' an, die das gesamte Sortiment und weitere Anwendungen beinhaltet.
For more information request our separate brochure 'Care & Welfare' for a wider assortment and other applications.



Project: La Défense Offices
Architect: Unstudio

  Woningbouw - binnendeuren

  Quincaillerie résidentielle - portes intérieures

 Wohnbereich - Innentüren

 Residential door furniture - Interior doors

3A



Luxuria Design Collectie
Collection de design
Design Kollektion
Design Collection

3B 151



Collectie RVS deurkrukken
Collection béquilles en inox
Kollektion Edelstahl Türdrücker
Collection stainless steel levers

3D 181



Vastdraaibaar op rozet zonder nokken
Fixe sur rosace sans comes
Festdrehbar auf Rosette ohne Nocken
Fixed with spring on rose without lugs

3E 237



Vastdraaibaar op schroefrozet
Fixe sur rosace spirale
Festdrehbar auf Überschraubrossette
Fixed with spring on threaded rose

3F 245



Langschilden
Plaques longues
Langschilder
Long plates

3G 255



Collectie Jaren-30 ('Ton' model)
Collection années-30 (modèle 'Ton')
Kollektion Jahre-30 (Modell 'Ton')
Collection 1930th ('Ton' model)

3H 265



Collection Interior Accents
Kollektion Interior Accents

3I 273



Collection 'Black is beautiful'
Kollektion 'Black is beautiful'

3J 289



Profieldeur
Porte à chasis profile
Schmallrahmen
Profile door

3K 293



LUXURIA

Design Collection



LUXURIA

Design Collectie • Collection de design • Design Kollektion • Design Collection

3B



Livanto 157



Tiffany 166



5th Avenue 154



Soho 164



Tiffany 165



Condotti 155



Tivoli 167



Urban 170



Condotti 156



Prado 161



Vola 176



Manhattan 158



Serrano 163



Manhattan 159



Manhattan 160

LUXURIA

Design Collectie • Collection de design • Design Kollektion • Design Collection

3B



Tirza 168



Urban 171



Vola 177



Tirza 169



Urban 172



Vola 178



Versa 174



Urban 173



Vola 179



Versa 175



Rivamonte 162

5th Avenue

Luxuria Design

LUXURIA

3B

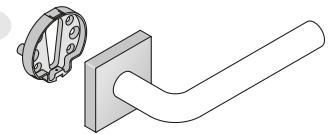
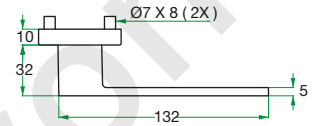
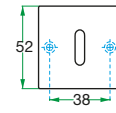
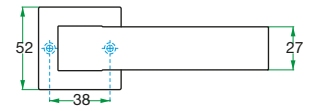
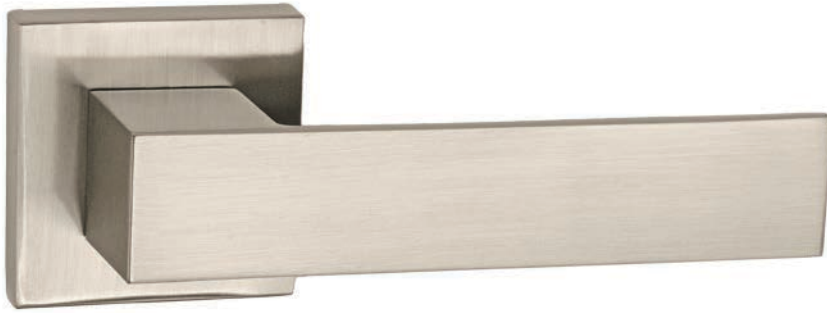

- Nikkel mat geborsteld
- Luxuria Design Collectie
- Deurkruk vastdraaibaar met veer
- Zamac onderconstructie



- Nickel mat brossé
- Luxuria Collection de design
- Béquille fixe avec ressort de retenue
- Sous-construction en zamac



- Nickel matt gebürstet
- Luxuria Design Kollektion
- Drücker festdrehbar mit Hochhaltefeder
- Zink Druckguß Unterkonstruktion



- Satin nickel
- Luxuria Design Collection
- Lever sprungloaded
- Zinc diecast understructure



		L5031
		L5032

		8 mm	L5033



L0501	



L0502	



	8 mm
--	------



L0503-T3

Condotti

Luxuria Design

LUXURIA

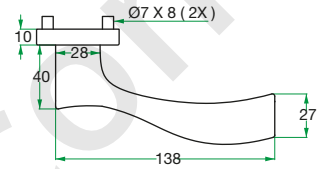
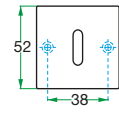
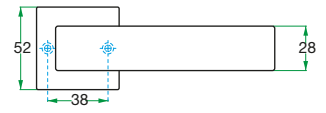

3B

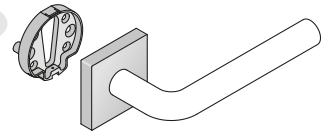

- Nikkel mat geborsteld
- Luxuria Design Collectie
- Deurkruk vastdraaibaar met veer
- Zamac onderconstructie



- Nickel mat brossé
- Luxuria Collection de design
- Béquille fixe avec ressort de retenue
- Sous-construction en zamac



- Nickel matt gebürstet
- Luxuria Design Kollektion
- Drücker festdrehbar mit Hochhaltefeder
- Zink Druckguß Unterkonstruktion



- Satin nickel
- Luxuria Design Collection
- Lever sprungloaded
- Zinc diecast understructure

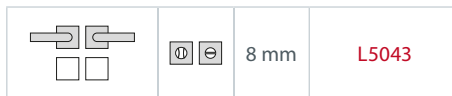
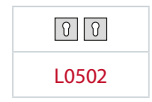
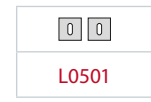

Condotti

Luxuria Design

LUXURIA

3B

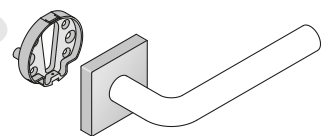
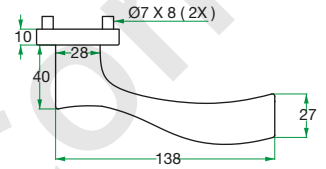
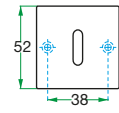
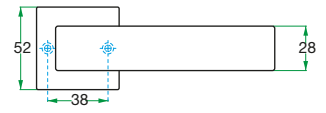

- Antiek zilver
- Luxuria Design Collectie
- Deurkruk vastdraaibaar met veer
- Zamac onderconstructie



- Argenté antique
- Luxuria Collection de design
- Béquille fixe avec ressort de retenue
- Sous-construction en zamac



- Antik Silber
- Luxuria Design Kollektion
- Drücker festdrehbar mit Hochhaltefeder
- Zink Druckguß Unterkonstruktion



- Antique silver
- Luxuria Design Collection
- Lever sprungloaded
- Zinc diecast understructure



		L5051
		L5052

		8 mm	L5053
--	--	------	-------



	L0511
--	-------



	L0512
--	-------



	8 mm
--	------



	L0513-T3
--	----------

Livanto

Luxuria Design

LUXURIA

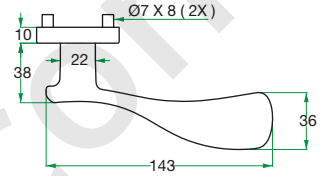
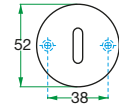
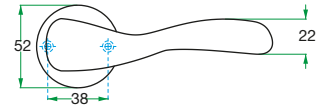

3B

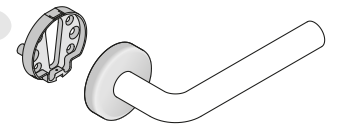

- Nikkel mat geborsteld
- Luxuria Design Collectie
- Deurkruk vastdraaibaar met veer
- Zamac onderconstructie



- Nickel mat brossé
- Luxuria Collection de design
- Béquille fixe avec ressort de retenue
- Sous-construction en zamac



- Nickel matt gebürstet
- Luxuria Design Kollektion
- Drücker festdrehbar mit Hochhaltefeder
- Zink Druckguß Unterkonstruktion



- Satin nickel
- Luxuria Design Collection
- Lever sprungloaded
- Zinc diecast understructure

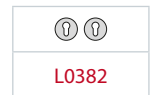
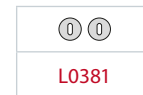

		L3981
		L3982

			8 mm	L3983
--	--	--	------	-------

Manhattan

Luxuria Design

LUXURIA

3B

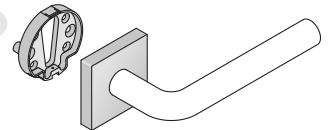
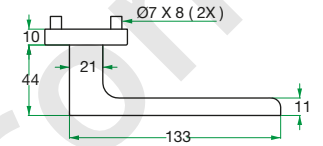
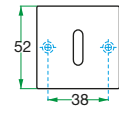
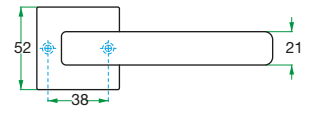
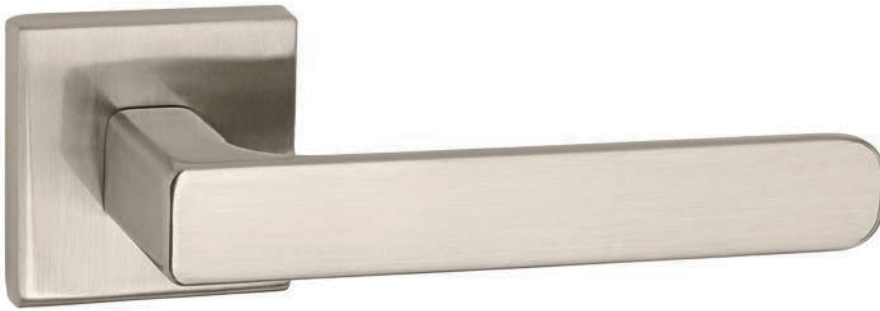

- Nikkel mat geborsteld
- Luxuria Design Collectie
- Deurkruk vastdraaibaar met veer
- Zamac onderconstructie



- Nickel mat brossé
- Luxuria Collection de design
- Béquille fixe avec ressort de retenue
- Sous-construction en zamac



- Nickel matt gebürstet
- Luxuria Design Kollektion
- Drücker festdrehbar mit Hochhaltefeder
- Zink Druckguß Unterkonstruktion



- Satin nickel
- Luxuria Design Collection
- Lever sprungloaded
- Zinc diecast understructure

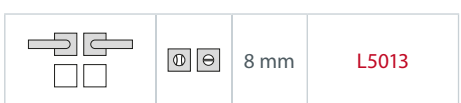
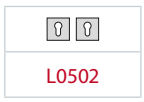
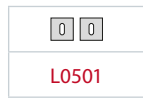

Manhattan

Luxuria Design

LUXURIA

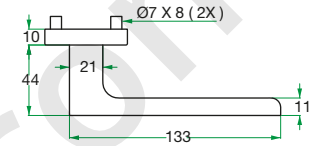
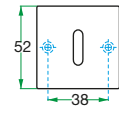
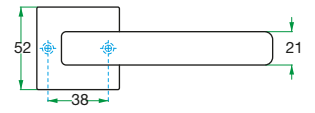
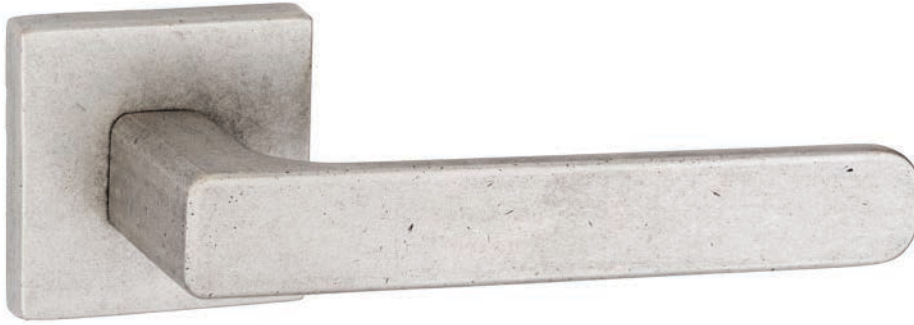

3B

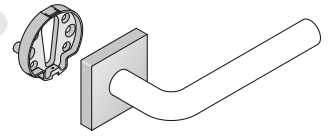

- Antiek zilver
- Luxuria Design Collectie
- Deurkruk vastdraaibaar met veer
- Zamac onderconstructie

- Argenté antique
- Luxuria Collection de design
- Béquille fixe avec ressort de retenue
- Sous-construction en zamac

- Antik Silber
- Luxuria Design Kollektion
- Drücker festdrehbar mit Hochhaltefeder
- Zink Druckguß Unterkonstruktion

- Antique silver
- Luxuria Design Collection
- Lever sprungloaded
- Zinc diecast understructure

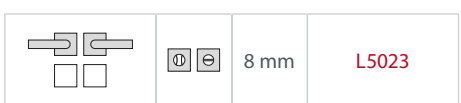
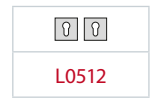
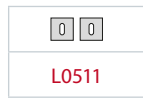

Manhattan

Luxuria Design

LUXURIA

3B

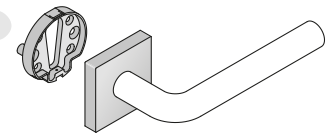
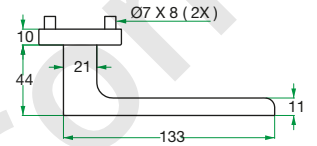
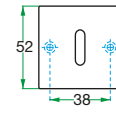
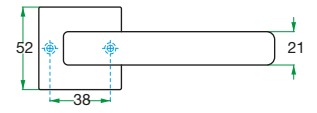

- Mat zwart
- Luxuria Design Collectie
- Deurkruk vastdraaibaar met veer
- Zamac onderconstructie



- Noir mate
- Luxuria Collection de design
- Béquille fixe avec ressort de retenue
- Sous-construction en zamac



- Schwarz matt
- Luxuria Design Kollektion
- Drücker festdrehbar mit Hochhaltefeder
- Zink Druckguß Unterkonstruktion



- Satin black
- Luxuria Design Collection
- Lever sprungloaded
- Zinc diecast understructure

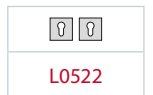
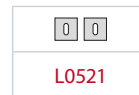

		L5061
		L5062

		8 mm	L5063
--	--	------	-------



Prado

Luxuria Design

LUXURIA

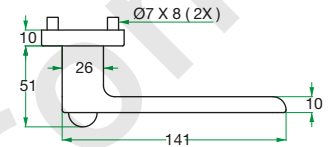
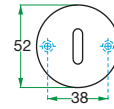
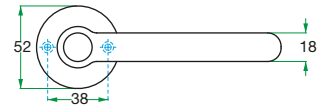

3B

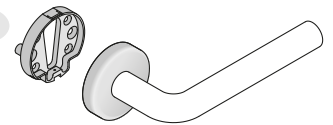
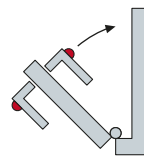

- Met geïntegreerde deurbuffer
- Nikkel mat geborsteld
- Luxuria Design Collectie
- Deurkruk vastdraaibaar met veer
- Zamac onderconstructie



- Avec arrêt de porte intégré
- Nickel mat brossé
- Luxuria Collection de design
- Béquille fixe avec ressort de retenue
- Sous-constructie en zamac



- Mit integriertem Türstopper
- Nickel matt gebürstet
- Luxuria Design Kollektion
- Drücker festdrehbar mit Hochhaltefeder
- Zink Druckguß Unterkonstruktion



- With integrated doorstop
- Satin nickel
- Luxuria Design Collection
- Lever sprungloaded
- Zinc diecast understructure

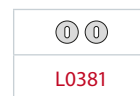

L0381

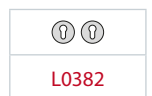

L0382



8 mm



L0383-T3

		L3861
		L3862

		8 mm	L3863
--	--	------	-------

Rivamonte

Luxuria Design

LUXURIA

3B

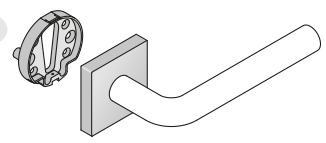
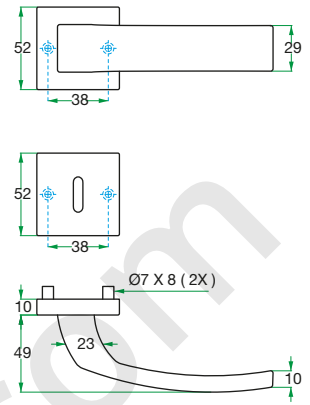

- Mat zwart
- Luxuria Design Collectie
- Deurkruk vastdraaibaar met veer
- Zamac onderconstructie

- Noir mate
- Luxuria Collection de design
- Béquille fixe avec ressort de retenue
- Sous-construction en zamac

- Schwarz matt
- Luxuria Design Kollektion
- Drücker festdrehbar mit Hochhaltefeder
- Zink Druckguß Unterkonstruktion

- Satin black
- Luxuria Design Collection
- Lever sprungloaded
- Zinc diecast understructure

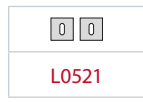

		L5071
		L5072

		8 mm	L5073



Serrano

Luxuria Design

LUXURIA

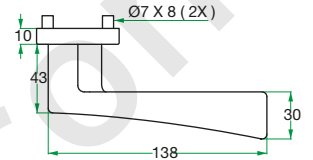
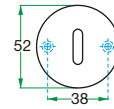

3B

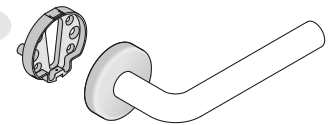

- Nikkel mat geborsteld
- Luxuria Design Collectie
- Deurkruk vastdraaibaar met veer
- Zamac onderconstructie



- Nickel mat brossé
- Luxuria Collection de design
- Béquille fixe avec ressort de retenue
- Sous-constructie en zamac



- Nickel matt gebürstet
- Luxuria Design Kollektion
- Drücker festdrehbar mit Hochhaltefeder
- Zink Druckguß Unterkonstruktion



- Satin nickel
- Luxuria Design Collection
- Lever sprungloaded
- Zinc diecast understructure

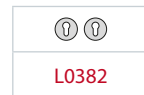
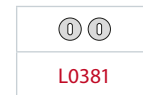

		L3871
		L3872

		8 mm	L3873
--	--	------	-------

Soho

Luxuria Design

LUXURIA

3B

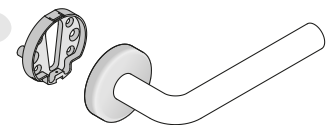
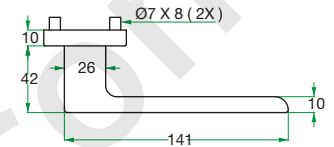
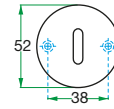
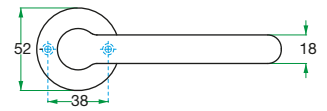

- Nikkel mat geborsteld
- Luxuria Design Collectie
- Deurkruk vastdraaibaar met veer
- Zamac onderconstructie



- Nickel mat brossé
- Luxuria Collection de design
- Béquille fixe avec ressort de retenue
- Sous-constructie en zamac



- Nickel matt gebürstet
- Luxuria Design Kollektion
- Drücker festdrehbar mit Hochhaltefeder
- Zink Druckguß Unterkonstruktion



- Satin nickel
- Luxuria Design Collection
- Lever sprungloaded
- Zinc diecast understructure



		L3851
		L3852

		8 mm	L3853
--	--	------	-------

L0381	L0382

8 mm	L0383-T3

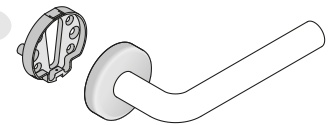
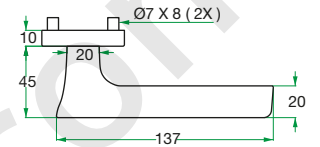
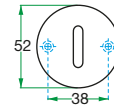
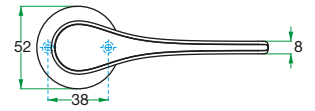

- Nikkel mat geborsteld
- Luxuria Design Collectie
- Deurkruk vastdraaibaar met veer
- Zamac onderconstructie



- Nickel mat brossé
- Luxuria Collection de design
- Béquille fixe avec ressort de retenue
- Sous-constructie en zamac



- Nickel matt gebürstet
- Luxuria Design Kollektion
- Drücker festdrehbar mit Hochhaltefeder
- Zink Druckguß Unterkonstruktion



- Satin nickel
- Luxuria Design Collection
- Lever sprungloaded
- Zinc diecast understructure

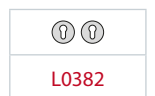
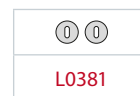

		L3821
		L3822

		8 mm	L3823
--	--	------	-------

3B

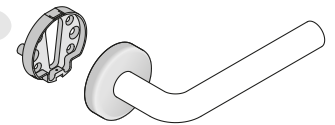
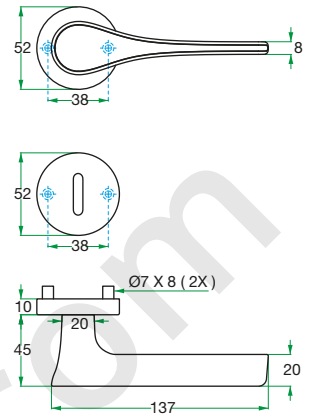

- Nikkel mat geborsteld
- Luxuria Design Collectie
- Deurkruk vastdraaibaar met veer
- Zamac onderconstructie



- Nickel mat brossé
- Luxuria Collection de design
- Béquille fixe avec ressort de retenue
- Sous-construction en zamac



- Nickel matt gebürstet
- Luxuria Design Kollektion
- Drücker festdrehbar mit Hochhaltefeder
- Zink Druckguß Unterkonstruktion



- Satin nickel
- Luxuria Design Collection
- Lever sprungloaded
- Zinc diecast understructure



		L3831
		L3832

		8 mm	L3833

	8 mm	L0383-T3
--	------	----------

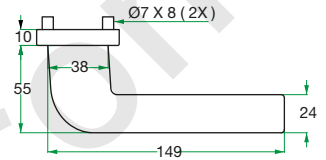
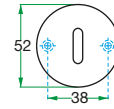
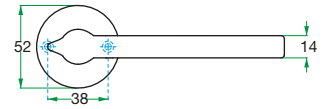

3B

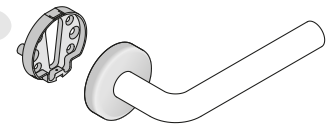

- Nikkel mat geborsteld
- Luxuria Design Collectie
- Deurkruk vastdraaibaar met veer
- Zamac onderconstructie



- Nickel mat brossé
- Luxuria Collection de design
- Béquille fixe avec ressort de retenue
- Sous-constructie en zamac



- Nickel matt gebürstet
- Luxuria Design Kollektion
- Drücker festdrehbar mit Hochhaltefeder
- Zink Druckguß Unterkonstruktion



- Satin nickel
- Luxuria Design Collection
- Lever sprungloaded
- Zinc diecast understructure



		L3841
		L3842

		8 mm	L3843
--	--	------	-------

Tirza

Luxuria Design

LUXURIA

3B

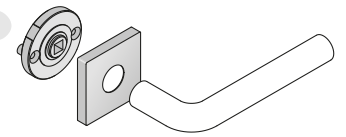
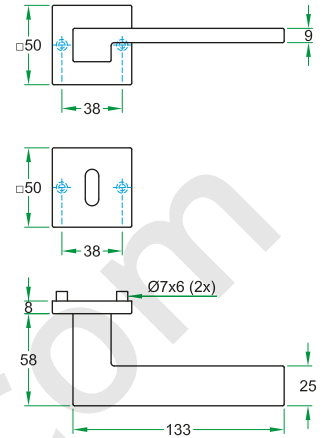

- PVD Nikkel mat geborsteld
- Luxuria Design Collectie
- Zamac onderconstructie met geïntegreerde veer



- PVD Nickel mat brossé
- Luxuria Collection de design
- Sous-construction en zamac avec ressort de retenue



- PVD Nickel mat gebürstet
- Luxuria Design Kollektion
- Zink Druckguß Unterkonstruktion mit integrierter Hochhaltefeder



- PVD Satin nickel
- Luxuria Design Collection
- Zinc diecast understructure with integrated spring

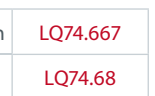
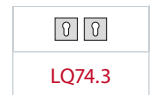
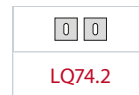

		L81440Q74.28
		L81440Q74.38

		8 mm	L81440Q74.688
--	--	------	---------------

Tirza

Luxuria Design

LUXURIA

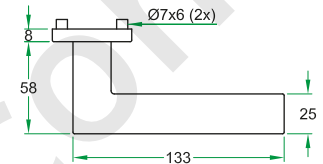
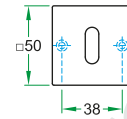
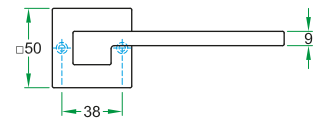

3B

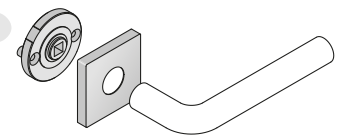

- Glans chroom
- Luxuria Design Collectie
- Zamac onderconstructie met geïntegreerde veer



- Chromé poli
- Luxuria Collection de design
- Sous-construction en zamac avec ressort de retenue



- Chrom poliert
- Luxuria Design Kollektion
- Zink Druckguß Unterkonstruktion mit integrierter Hochhaltefeder



- Polished chrome
- Luxuria Design Collection
- Zinc diecast understructure with integrated spring

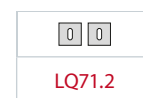

LQ71.2

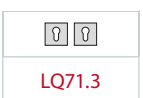

LQ71.3

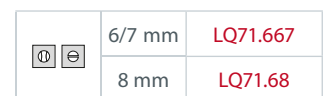

6/7 mm

LQ71.667

8 mm

LQ71.68



L81450Q71.28

L81450Q71.38

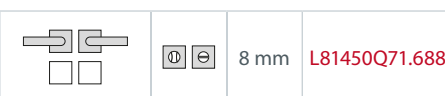

8 mm

L81450Q71.688

Urban

Luxuria Design

LUXURIA

3B

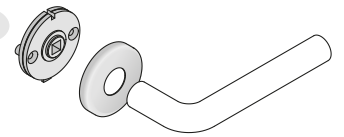
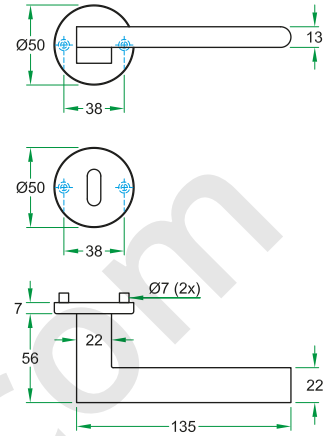

- PVD Nikkel mat geborsteld
- Luxuria Design Collectie
- Zamac onderconstructie met geïntegreerde veer



- PVD Nickel mat brossé
- Luxuria Collection de design
- Sous-construction en zamac avec ressort de retenue



- PVD Nickel mat gebürstet
- Luxuria Design Kollektion
- Zink Druckguß Unterkonstruktion mit integrierter Hochhaltefeder



- PVD Satin nickel
- Luxuria Design Collection
- Zinc diecast understructure with integrated spring



		L81610R74.28
		L81610R74.38

		8 mm	L81610R74.688
--	--	------	---------------



	6 mm	LR74.66
	7 mm	LR74.67
	8 mm	LR74.68

Urban

Luxuria Design

LUXURIA

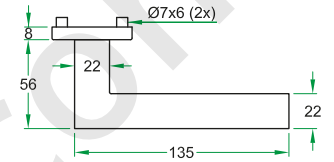
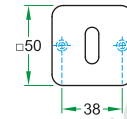
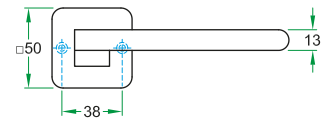

3B

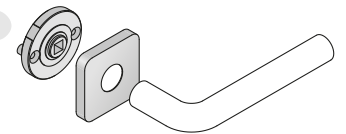

- PVD Nikkel mat geborsteld
- Luxuria Design Collectie
- Zamac onderconstructie met geïntegreerde veer



- PVD Nickel mat brossé
- Luxuria Collection de design
- Sous-construction en zamac avec ressort de retenue



- PVD Nickel mat gebürstet
- Luxuria Design Kollektion
- Zink Druckguß Unterkonstruktion mit integrierter Hochhaltefeder



- PVD Satin nickel
- Luxuria Design Collection
- Zinc diecast understructure with integrated spring



		L81610E74.28
		L81610E74.38

		8 mm	L81610E74.688

	6 mm	LE74.66
	7 mm	LE74.67
	8 mm	LE74.68

Urban

Luxuria Design

LUXURIA

3B

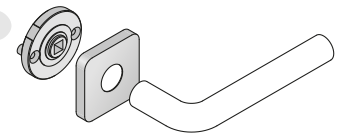
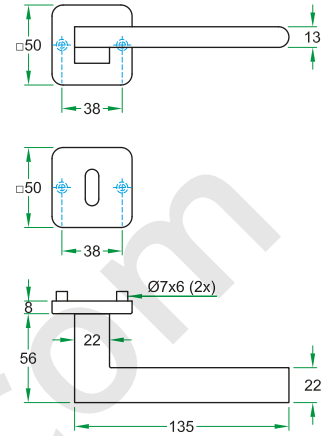

- Parel mat chroom
- Luxuria Design Collectie
- Zamac onderconstructie met geïntegreerde veer



- Chromé mat perlé
- Luxuria Collection de design
- Sous-constructie en zamac avec ressort de retenue



- Chrom matt perle
- Luxuria Design Kollektion
- Zink Druckguß Unterkonstruktion mit integrierter Hochhaltefeder



- Pearl satin chrome
- Luxuria Design Collection
- Zinc diecast understructure with integrated spring

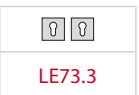

		L81620E73.28
		L81620E73.38

		8 mm	L81620E73.688
--	--	------	---------------



	6/7 mm	LE73.667
	8 mm	LE73.68

Urban

Luxuria Design

LUXURIA

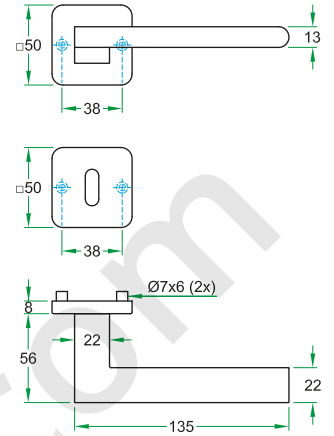

3B

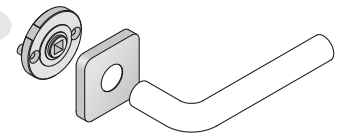

- Glans chroom
- Luxuria Design Collectie
- Zamac onderconstructie met geïntegreerde veer
- Rozet 50 x 50 x 8 mm



- Chromé poli
- Luxuria Collection de design
- Sous-constructie en zamac avec ressort de retenue
- Rosace 50 x 50 x 8 mm



- Chrom poliert
- Luxuria Design Kollektion
- Zink Druckguß Unterkonstruktion mit integrierter Hochhaltefeder
- Rosette 50 x 50 x 8 mm



- Polished chrome
- Luxuria Design Collection
- Zinc diecast understructure with integrated spring
- Rose 50 x 50 x 8 mm



		L81650E71.28
		L81650E71.38

		8 mm	L81650E71.688

3B

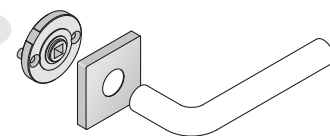
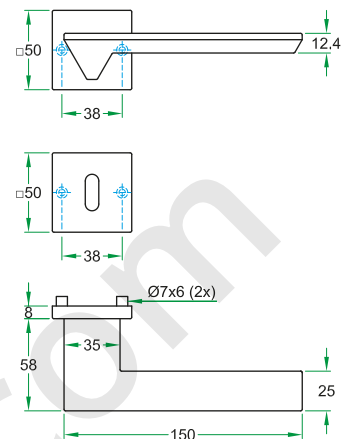

- PVD Nikkel mat geborsteld
- Luxuria Design Collectie
- Zamac onderconstructie met geïntegreerde veer



- PVD Nickel mat brossé
- Luxuria Collection de design
- Sous-construction en zamac avec ressort de retenue



- PVD Nickel mat gebürstet
- Luxuria Design Kollektion
- Zink Druckguß Unterkonstruktion mit integrierter Hochhaltefeder



- PVD Satin nickel
- Luxuria Design Collection
- Zinc diecast understructure with integrated spring



		L81430Q74.28
		L81430Q74.38



		8 mm	L81430Q74.688



LQ74.2	LQ74.3



	6/7 mm	LQ74.667
	8 mm	LQ74.68

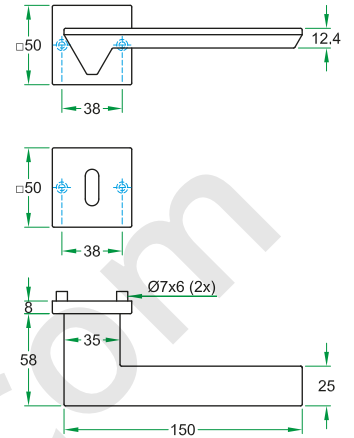

3B

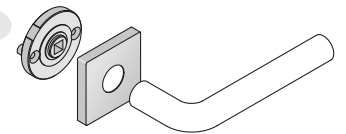

- Glans chroom
- Luxuria Design Collectie
- Zamac onderconstructie met geïntegreerde veer



- Chromé poli
- Luxuria Collection de design
- Sous-construction en zamac avec ressort de retenue



- Chrom poliert
- Luxuria Design Kollektion
- Zink Druckguß Unterkonstruktion mit integrierter Hochhaltefeder



- Polished chrome
- Luxuria Design Collection
- Zinc diecast understructure with integrated spring



		L81500Q71.28
		L81500Q71.38



		8 mm	L81500Q71.688



LQ71.2	LQ71.3



	6/7 mm	LQ71.667
	8 mm	LQ71.68



Vola

Luxuria Design

LUXURIA

3B

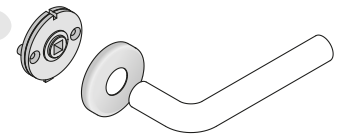
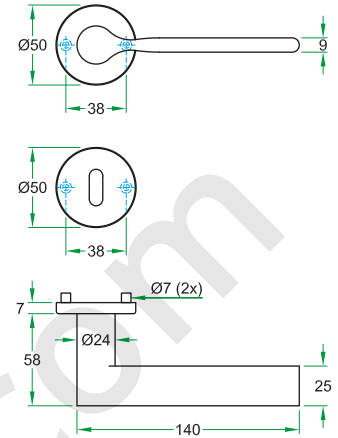

- PVD Nikkel mat geborsteld
- Luxuria Design Collectie
- Zamac onderconstructie met geïntegreerde veer



- PVD Nickel mat brossé
- Luxuria Collection de design
- Sous-construction en zamac avec ressort de retenue



- PVD Nickel mat gebürstet
- Luxuria Design Kollektion
- Zink Druckguß Unterkonstruktion mit integrierter Hochhaltefeder



- PVD Satin nickel
- Luxuria Design Collection
- Zinc diecast understructure with integrated spring

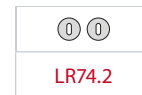

		L81520R74.28
		L81520R74.38

		8 mm	L81520R74.688

	6 mm	LR74.66
	7 mm	LR74.67
	8 mm	LR74.68

Vola

Luxuria Design

LUXURIA

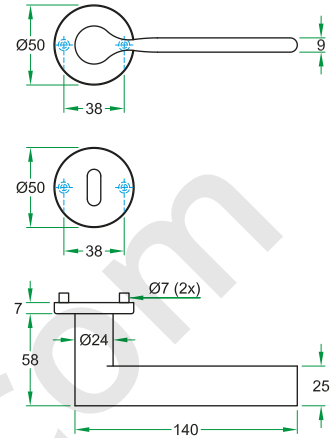

3B

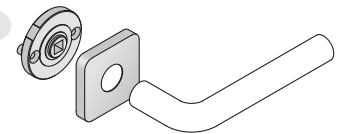

- PVD Nikkel mat geborsteld
- Luxuria Design Collectie
- Zamac onderconstructie met geïntegreerde veer



- PVD Nickel mat brossé
- Luxuria Collection de design
- Sous-construction en zamac avec ressort de retenue



- PVD Nickel mat gebürstet
- Luxuria Design Kollektion
- Zink Druckguß Unterkonstruktion mit integrierter Hochhaltefeder



- PVD Satin nickel
- Luxuria Design Collection
- Zinc diecast understructure with integrated spring

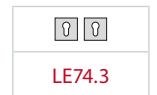

		L81520E74.28
		L81520E74.38

		8 mm	L81520E74.688

	6 mm	LE74.66
	7 mm	LE74.67
	8 mm	LE74.68

Vola

Luxuria Design

LUXURIA

3B

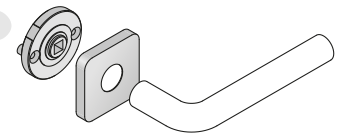
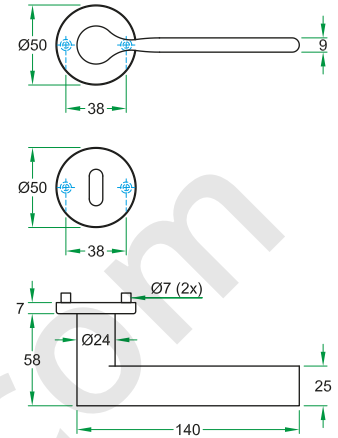
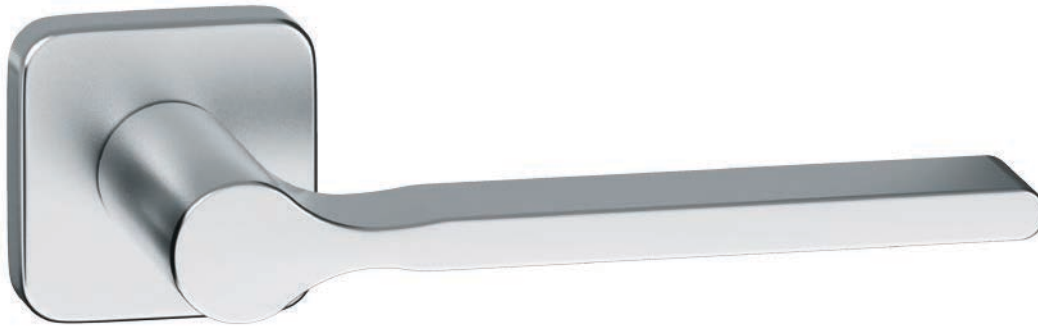

- Parel mat chroom
- Luxuria Design Collectie
- Zamac onderconstructie met geïntegreerde veer



- Chromé mat perlé
- Luxuria Collection de design
- Sous-construction en zamac avec ressort de retenue



- Chrom matt perle
- Luxuria Design Kollektion
- Zink Druckguß Unterkonstruktion mit integrierter Hochhaltefeder



- Pearl satin chrome
- Luxuria Design Collection
- Zinc diecast understructure with integrated spring



		L81530E73.28
		L81530E73.38

		8 mm	L81530E73.688

	6/7 mm	L81530E73.667
	8 mm	L81530E73.68

Vola

Luxuria Design

LUXURIA

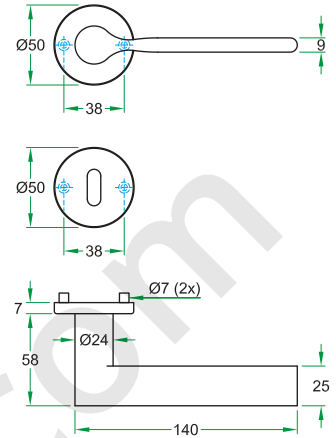

3B

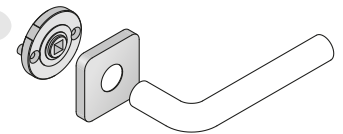

- Glans chroom
- Luxuria Design Collectie
- Zamac onderconstructie met geïntegreerde veer



- Chromé poli
- Luxuria Collection de design
- Sous-construction en zamac avec ressort de retenue



- Chrom poliert
- Luxuria Design Kollektion
- Zink Druckguß Unterkonstruktion mit integrierter Hochhaltefeder



- Polished chrome
- Luxuria Design Collection
- Zinc diecast understructure with integrated spring



		L81510E71.28
		L81510E71.38

		8 mm	L81510E71.688



  Collectie RVS deurkrukken

  Collection béquilles en inox

 Kollektion Edelstahl Türdrücker

 Collection stainless steel levers

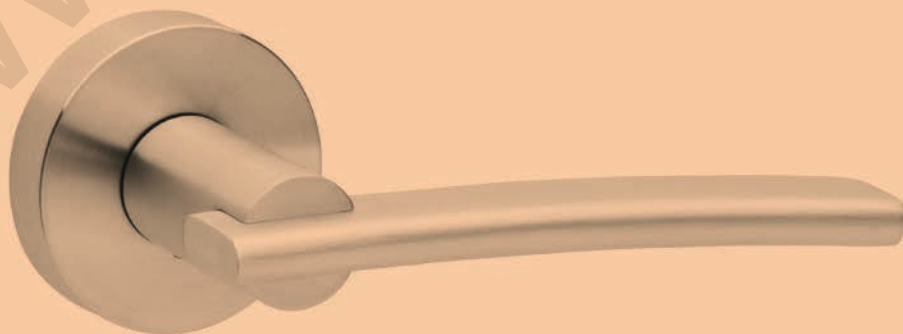

SE Rozet
 SE Rosace
 SE Rosette
 SE Rose

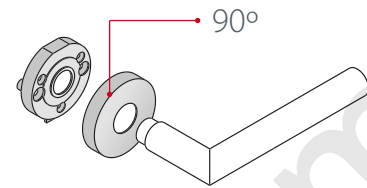

Ronde rozet
 Rosace ronde
 Runde Rosette
 Round rose

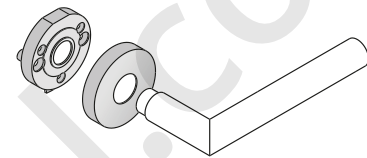

Vlakrozet 2 mm
 Rosace plate 2 mm
 Flachrosette 2 mm
 Flat rose 2 mm

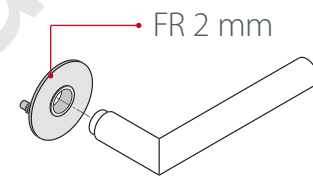
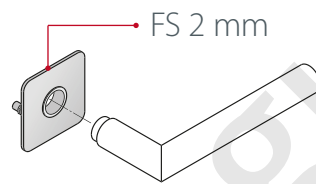

Vierkante rozet
 Rosace carrée
 Eckige Rosette
 Square Rose

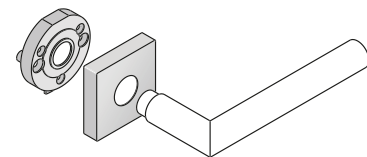

Vastdraaibaar op schroefrozet
 Fixe sur rosace spirale
 Festschraubbar auf Überschraubrosette
 Fixed with spring on threaded rose

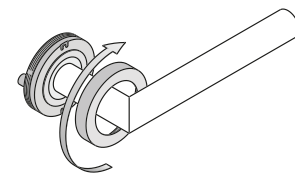

Vastdraaibaar op rozet zonder nokken
 Fixe sur rosace sans comes
 Festschraubbar auf Rosette ohne Nocken
 Fixed with spring on rose without lugs

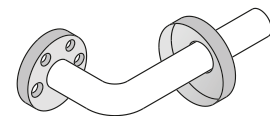

Profieldeur
 Porte à chassis profile
 Schmalrahmen
 Profile door

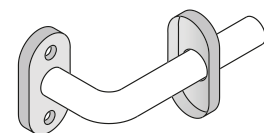



Tipo 225



Uno 231



Lido 210



Tipo FR - FS 227



Tipo SQ 226



Tipo SC 252



Uno SC 253



Trio 243



Donna 239



Lita 241



Tipo PD 297



Clara PD 295



Lido PD 296

Ronde rozet
Rosace ronde
Runde Rosette
Round rose

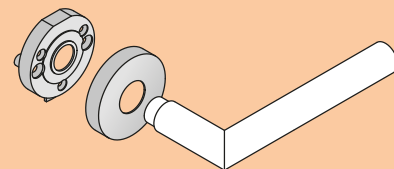

3C



Cino 189



Dorina 190



Fiona 193



Gino 194



Gisela 195



Hala 198



Ilsa 199



Jade 200



Lana 203



Lido 210



Pipo 212



Polo 213



Primo 217



Saba 218



Sipo 223



Tipo 225



Uno 231



Wing 233

Componenten / Composants / Zubehör / Components 234

SE Rozet
 SE Rosace
 SE Rosette
 SE Rose

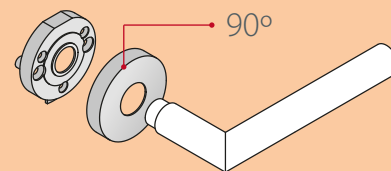

Dorina SE 191



Polo SE 214



Laura SE 208



Gisela SE 196



Saba SE 219



Lana SE 204

Componenten / Composants / Zubehör / Components 234

3C

FR Vlakrozet 2 mm
 FR Rosace plate 2 mm
 FR Flachrosette 2 mm
 FR Flat rose 2 mm

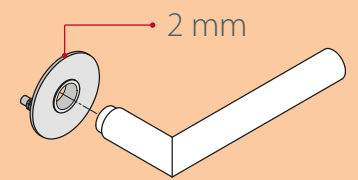

3C



Dorina FR 192



Polo FR 215



Tipo FR 227



Gisela FR 197



Saba FR 220



Tipo FRP 228



Lana FR 205

Componenten / Composants / Zubehör / Components 234

Vierkante rozet
Rosace carrée
Eckige Rosette
Square Rose

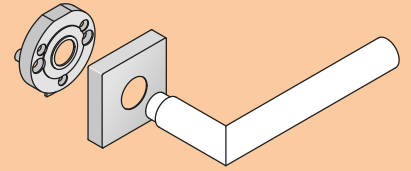

Karina 201



Sabrina 221

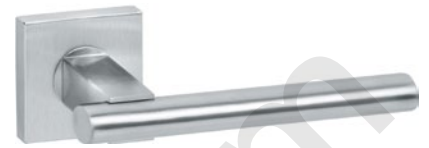

Vogue 232



Laura 207



Tec 224

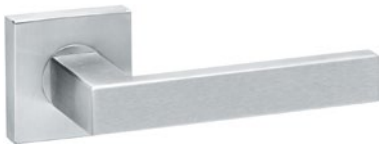

Metro 211

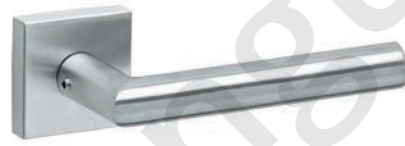

Tipo SQ 226

Componenten / Composants / Zubehör / Components 234

FS Vlakrozet 2 mm
 FS Rosace plate 2 mm
 FS Flachrosette 2 mm
 FS Flat rose 2 mm

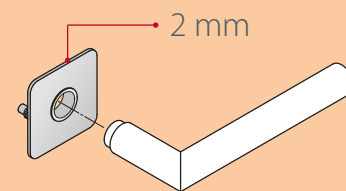

3C



Karina FS 202

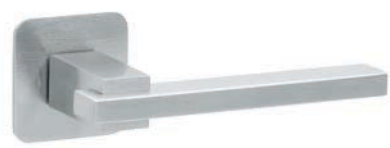

Sabrina FS 222



Tipo FS 229



Laura FS 30



Polo FS 30



Tipo FSP 230



Lana FS 206

Componenten / Composants / Zubehör / Components 234

Cino

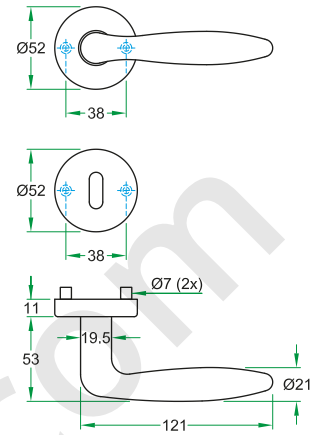

3D



- RVS mat geborsteld
- Kunststof onderconstructie met geïntegreerde veer



- Inox mat brossé
- Sous-structure nylon avec ressort de retenue



- Edelstahl matt gebürstet
- Kunststoff Unterkonstruktion mit integrierter Hochhaltefeder



- Satin stainless steel
- Nylon understructure with integrated spring



		00191-WCX
		00192-WCX



		8 mm	00193-WCX



	2R10.WCX
--	----------



	2R11.WCX
--	----------



	2R12.WCX
--	----------



	6/7 mm	2R10.T67.WCX
	8 mm	2R10.T8.WCX

	Paar / Paire Paar / Pair	00190
--	-----------------------------	-------

Combineerbaar met / A combiner avec
Kombinierbar mit / Combine with

	Schild / Plaque / Schild / Plate	255
--	----------------------------------	-----

Dorina

3D

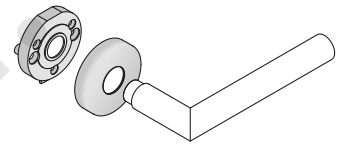
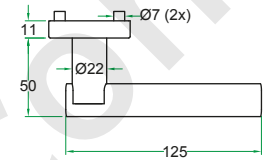
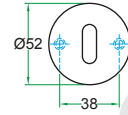
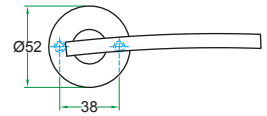

- RVS mat geborsteld
- Kunststof onderconstructie met geïntegreerde veer



- Inox mat brossé
- Sous-structure nylon avec ressort de retenue



- Edelstahl matt gebürstet
- Kunststoff Unterkonstruktion mit integrierter Hochhaltefeder



- Satin stainless steel
- Nylon understructure with integrated spring

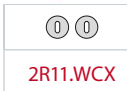

		00521
		00522

		8 mm	00523
--	--	------	-------

	6/7 mm	2R10.T67.WCX
	8 mm	2R10.T8.WCX

	Paar / Paire Paar / Pair	00520
--	-----------------------------	-------

Combineerbaar met / A combiner avec
Kombinierbar mit / Combine with

	Schild / Plaque / Schild / Plate	255
--	----------------------------------	-----

Dorina SE

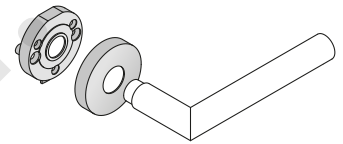
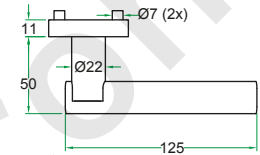
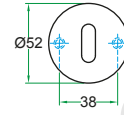
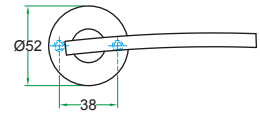

3D



- SE = Rozet met 90° rand
- RVS cirkel geborsteld
- Kunststof onderconstructie met geïntegreerde veer



- SE = Rosace avec 90° bord
- Inox brossé circulaire
- Sous-construction nylon avec ressort de retenue



- SE = Rosette mit 90° Rand
- Edelstahl kreisförmig gebürstet
- Kunststoff Unterkonstruktion mit integrierter Hochhaltefeder



- SE = Rose with 90° edge
- Circle brushed stainless steel
- Nylon understructure with integrated spring



		00531
		00532



		8 mm	00533



	2R30.SE
--	---------



	2R31.SE
--	---------



	2R32.SE
--	---------



	6/7 mm	2R30.T67.SE
	8 mm	2R30.T8.SE



	8 mm	2R30.T8.SE
--	------	------------

	Paar / Paire Paar / Pair	00520
--	-----------------------------	-------

Combineerbaar met / A combiner avec
Kombinierbar mit / Combine with

	Schild / Plaque / Schild / Plate	255
--	----------------------------------	-----

Dorina FR

3D

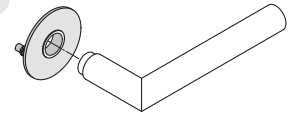
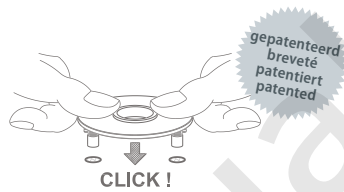
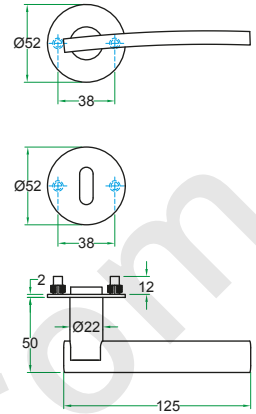

- FR = 2 mm vlakrozet
- Rozetmontage zonder schroeven
- Minimalistische uitstraling
- Zonder veer



- FR = Rosace plate 2 mm
- Montage de la rosace sans vis
- Radiation minimaliste
- Sans ressort de retenue



- FR = 2 mm Flachrosette
- Montage der Rosette ohne Schrauben
- Minimalistische Ausstrahlung
- Ohne Hochhaltefeder



- FR = 2 mm flat rose
- Assembly without screws
- Minimalistic look
- Unsprung



		00541
		00542



		8 mm	00543
--	--	------	-------



	04101
--	-------



	04106
--	-------



	04107
--	-------



	6/7 mm	04112/T67
	8 mm	04112/T8



	8 mm	04112/T8
--	------	----------

	Paar / Paire Paar / Pair	00520
--	-----------------------------	-------

Combineerbaar met / A combiner avec
Kombinierbar mit / Combine with

	Schild / Plaque / Schild / Plate	255
--	----------------------------------	-----

Fiona

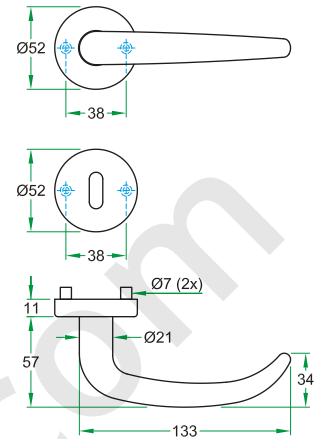

3D

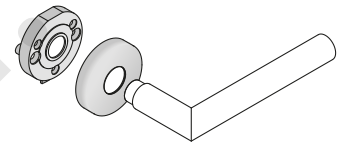

- RVS mat geborsteld
- Kunststof onderconstructie met geïntegreerde veer



- Inox mat brossé
- Sous-construction nylon avec ressort de retenue



- Edelstahl matt gebürstet
- Kunststoff Unterkonstruktion mit integrierter Hochhaltefeder



- Satin stainless steel
- Nylon understructure with integrated spring



2R10.WCX

2R11.WCX

2R12.WCX

		00881-WCX
		00882-WCX

		8 mm	00883-WCX
--	--	------	-----------

	6/7 mm	2R10.T67.WCX
	8 mm	2R10.T8.WCX

Gino

3D

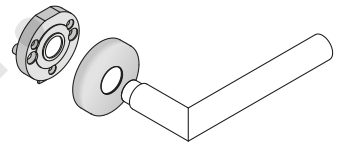
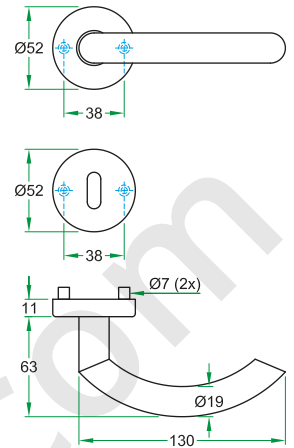

- RVS mat geborsteld
- Kunststof onderconstructie met geïntegreerde veer



- Inox mat brossé
- Sous-structure nylon avec ressort de retenue



- Edelstahl matt gebürstet
- Kunststoff Unterkonstruktion mit integrierter Hochhaltefeder



- Satin stainless steel
- Nylon understructure with integrated spring



	⓪ ⓪	00181-WCX
	⓪ ⓪	00182-WCX



	⓪ ⊖	8 mm	00183-WCX
	⓪ ⊖		



⓪ ⊖	2R10.WCX
-----	----------



⓪ ⊖	2R11.WCX
-----	----------



⓪ ⊖	2R12.WCX
-----	----------



	6/7 mm	2R10.T67.WCX
	8 mm	2R10.T8.WCX

	Paar / Paire Paar / Pair	00180-WCX
--	-----------------------------	-----------

Combineerbaar met / A combiner avec
Kombinierbar mit / Combine with

	Schild / Plaque / Schild / Plate		255
--	----------------------------------	--	-----

Gisela

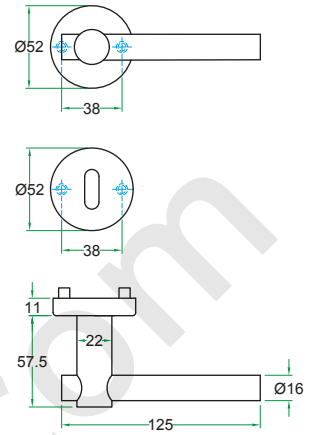

3D



- RVS mat geborsteld
- Kunststof onderconstructie met geïntegreerde veer



- Inox mat brossé
- Sous-structure nylon avec ressort de retenue



- Edelstahl matt gebürstet
- Kunststoff Unterkonstruktion mit integrierter Hochhaltefeder



- Satin stainless steel
- Nylon understructure with integrated spring



	⓪ ⓪	00821-WCX
	⓪ ⓪	00822-WCX

	⓪ ⊖	8 mm	00823-WCX
--	-----	------	-----------

	⓪ ⊖	6/7 mm	2R10.T67.WCX
	⓪ ⊖	8 mm	2R10.T8.WCX

	Paar / Paire Paar / Pair	00820
--	-----------------------------	-------

Combineerbaar met / A combiner avec
Kombinierbar mit / Combine with

	Schild / Plaque / Schild / Plate	255
--	----------------------------------	-----

Gisela SE

3D

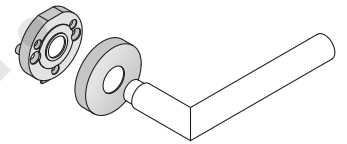
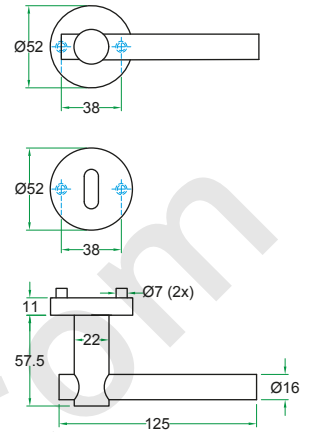

- SE = Rozet met 90° rand
- RVS cirkel geborsteld
- Kunststof onderconstructie met geïntegreerde veer



- SE = Rosace avec 90° bord
- Inox brossé circulaire
- Sous-construction nylon avec ressort de retenue



- SE = Rosette mit 90° Rand
- Edelstahl kreisförmig gebürstet
- Kunststoff Unterkonstruktion mit integrierter Hochhaltefeder



- SE = Rose with 90° edge
- Circle brushed stainless steel
- Nylon understructure with integrated spring



		01211
		01212



		8 mm	01213
--	--	------	-------



	2R30.SE
--	---------



	2R31.SE
--	---------



	2R32.SE
--	---------



	6/7 mm	2R30.T67.SE
	8 mm	2R30.T8.SE



	8 mm	2R30.T8.SE
--	------	------------

	Paar / Paire Paar / Pair	00820
--	-----------------------------	-------

Combineerbaar met / A combiner avec
Kombinierbar mit / Combine with

	Schild / Plaque / Schild / Plate	255
--	----------------------------------	-----

Gisela FR

3D

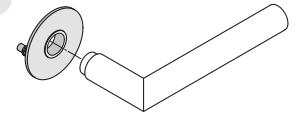
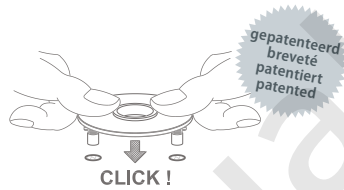
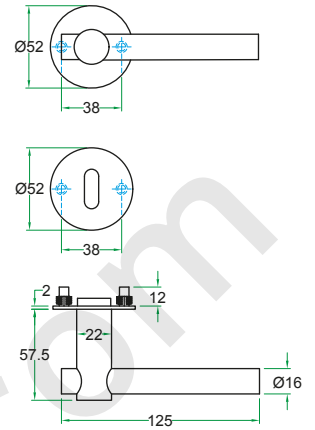
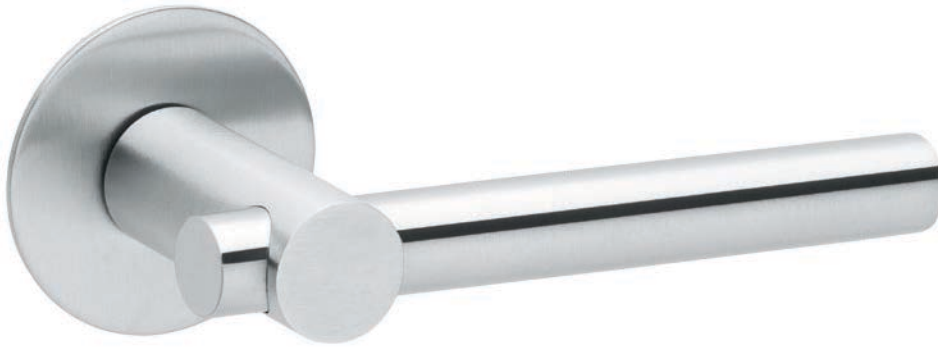

- FR = 2 mm vlakrozet
- Rozetmontage zonder schroeven
- Minimalistische uitstraling
- Zonder veer



- FR = Rosace plate 2 mm
- Montage de la rosace sans vis
- Radiation minimaliste
- Sans ressort de retenue



- FR = 2 mm Flachrosette
- Montage der Rosette ohne Schrauben
- Minimalistische Ausstrahlung
- Ohne Hochhaltefeder



- FR = 2 mm flat rose
- Assembly without screws
- Minimalistic look
- Unsprung



		01221
		01222

		8 mm	01223
--	--	------	-------

	6/7 mm	04112/T67
	8 mm	04112/T8

	Paar / Paire Paar / Pair	00820
--	-----------------------------	-------

Combineerbaar met / A combiner avec
Kombinierbar mit / Combine with

	Schild / Plaque / Schild / Plate	255
--	----------------------------------	-----

Hala

3D

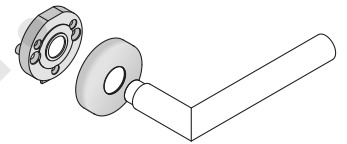
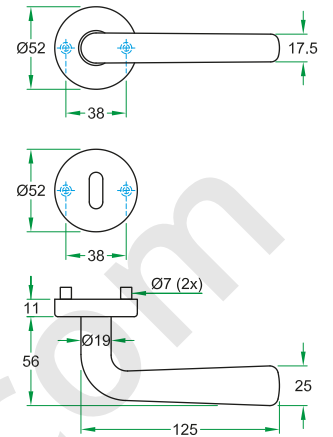

- RVS mat geborsteld
- Kunststof onderconstructie met geïntegreerde veer



- Inox mat brossé
- Sous-construction nylon avec ressort de retenue



- Edelstahl matt gebürstet
- Kunststoff Unterkonstruktion mit integrierter Hochhaltefeder



- Satin stainless steel
- Nylon understructure with integrated spring



2R10.WCX

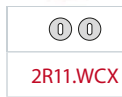

2R11.WCX



2R12.WCX



Ⓜ ⊖	6/7 mm	2R10.T67.WCX
	8 mm	2R10.T8.WCX

Ⓜ ⊖	Ⓜ ⊕	00861-WCX
	Ⓜ ⊖	00862-WCX

Ⓜ ⊖	Ⓜ ⊕	8 mm	00863-WCX
-----	-----	------	-----------

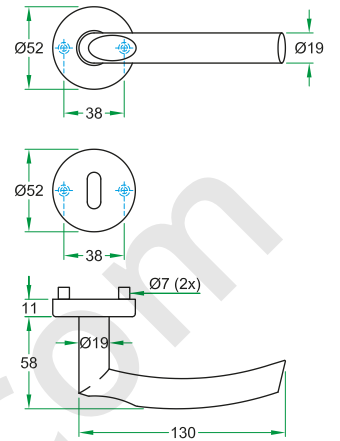

3D



- RVS mat geborsteld
- Kunststof onderconstructie met geïntegreerde veer



- Inox mat brossé
- Sous-structure nylon avec ressort de retenue



- Edelstahl matt gebürstet
- Kunststoff Unterkonstruktion mit integrierter Hochhaltefeder



- Satin stainless steel
- Nylon understructure with integrated spring



	⓪ ⓪	00841-WCX
	⓪ ⓪	00842-WCX

	⓪ ⊖	8 mm	00843-WCX
--	-----	------	-----------

⓪ ⊖	⓪ ⓪	⓪ ⓪
2R10.WCX	2R11.WCX	2R12.WCX
⓪ ⊖	6/7 mm	2R10.T67.WCX
	8 mm	2R10.T8.WCX

	Paar / Paire Paar / Pair	00840-WCX
--	-----------------------------	-----------

Combineerbaar met / A combiner avec
Kombinierbar mit / Combine with

	Schild / Plaque / Schild / Plate		255
--	----------------------------------	--	-----

Jade

3D

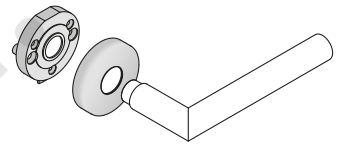
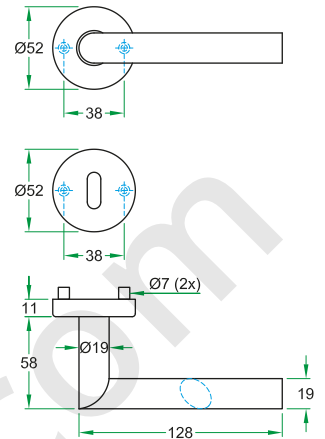

- RVS mat geborsteld
- Kunststof onderconstructie met geïntegreerde veer



- Inox mat brossé
- Sous-structure nylon avec ressort de retenue



- Edelstahl matt gebürstet
- Kunststoff Unterkonstruktion mit integrierter Hochhaltefeder



- Satin stainless steel
- Nylon understructure with integrated spring

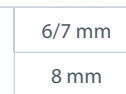

6/7 mm

2R10.T67.WCX

8 mm

2R10.T8.WCX

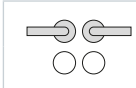

① ①

00801-WCX

② ②

00802-WCX

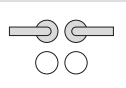

④ ⑤

8 mm

00803-WCX



Paar / Paire
Paar / Pair

00800-WCX

Combineerbaar met / A combiner avec
Kombinierbar mit / Combine with



Schild / Plaque / Schild / Plate

255

Karina

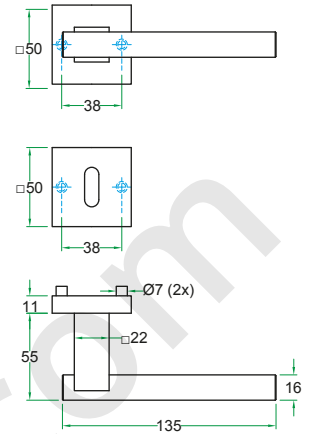
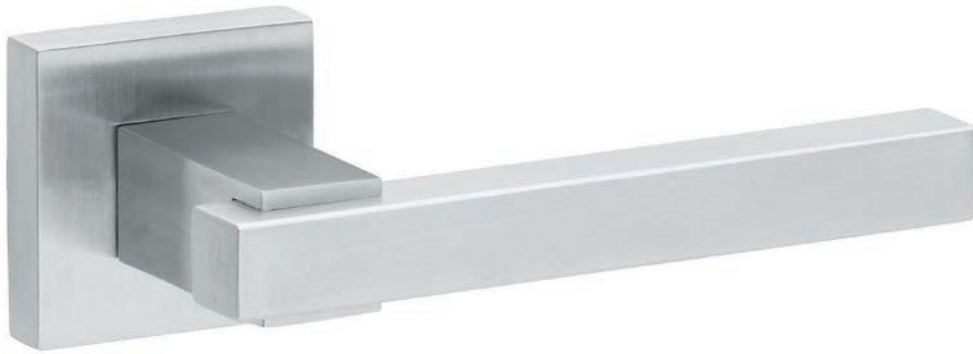

3D

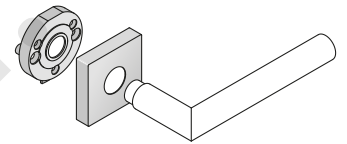

- RVS mat geborsteld
- Kunststof onderconstructie met geïntegreerde veer



- Inox mat brossé
- Sous-structure nylon avec ressort de retenue



- Edelstahl matt gebürstet
- Kunststoff Unterkonstruktion mit integrierter Hochhaltefeder



- Satin stainless steel
- Nylon understructure with integrated spring

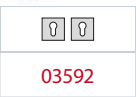
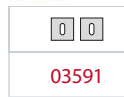
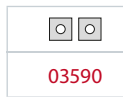
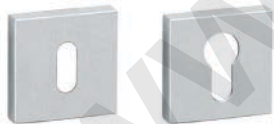

		00501
		00502

		8 mm	00503
--	--	------	-------

	6/7 mm	03596
	8 mm	03594

	Paar / Paire Paar / Pair	00500
--	-----------------------------	-------

Combineerbaar met / A combiner avec
Kombinierbar mit / Combine with

	Schild / Plaque / Schild / Plate		255
--	----------------------------------	--	-----

Karina FS

3D

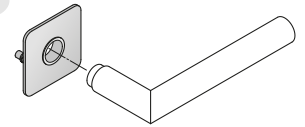
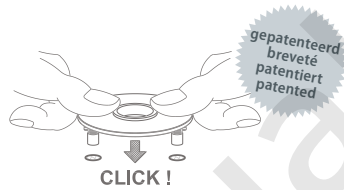
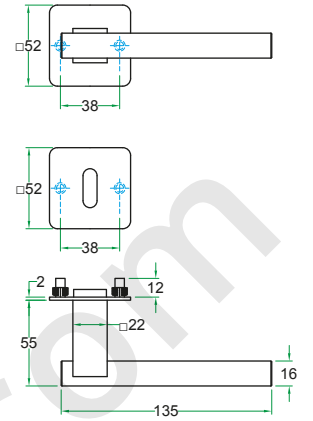
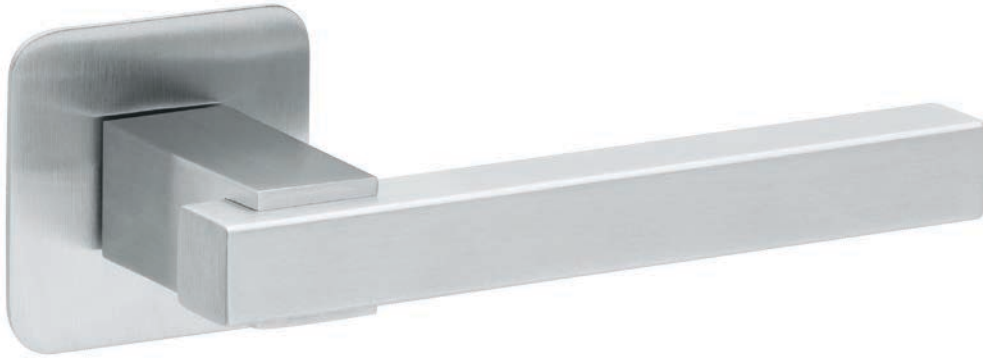

- FS = 2 mm vlakrozet
- Rozetmontage zonder schroeven
- Minimalistische uitstraling
- Zonder veer



- FS = Rosace plate 2 mm
- Montage de la rosace sans vis
- Radiation minimaliste
- Sans ressort de retenue



- FS = 2 mm Flachrosette
- Montage der Rosette ohne Schrauben
- Minimalistische Ausstrahlung
- Ohne Hochhaltefeder



- FS = 2 mm flat rose
- Assembly without screws
- Minimalistic look
- Unsprung

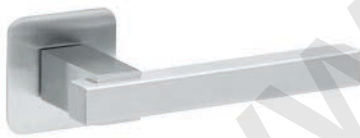

		00551
		00552



		8 mm	00553



	04201
--	-------



	04206
--	-------



	04207
--	-------



	6/7 mm	04212/T67
	8 mm	04212/T8



	6/7 mm	04212/T67
	8 mm	04212/T8

	Paar / Paire Paar / Pair	00500
--	-----------------------------	-------

Combineerbaar met / A combiner avec
Kombinierbar mit / Combine with

	Schild / Plaque / Schild / Plate	255
--	----------------------------------	-----

Lana

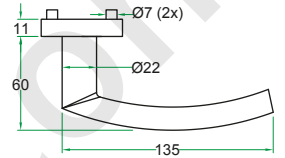
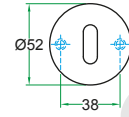
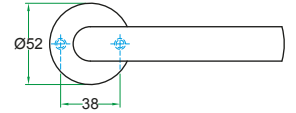

3D

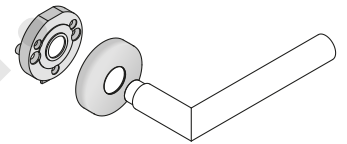

- RVS mat geborsteld
- Kunststof onderconstructie met geïntegreerde veer



- Inox mat brossé
- Sous-structure nylon avec ressort de retenue



- Edelstahl matt gebürstet
- Kunststoff Unterkonstruktion mit integrierter Hochhaltefeder



- Satin stainless steel
- Nylon understructure with integrated spring



	① ①	00971
	② ②	00972

	① ②	8 mm	00973
--	-----	------	-------

	6/7 mm	2R10.T67.WCX
	8 mm	2R10.T8.WCX

	Paar / Paire Paar / Pair	00970
--	-----------------------------	-------

Combineerbaar met / A combiner avec
Kombinierbar mit / Combine with

	Schild / Plaque / Schild / Plate	255
--	----------------------------------	-----

Lana SE

3D

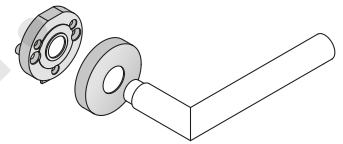
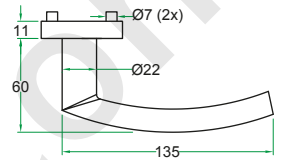
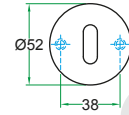
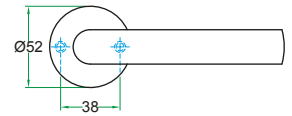

- SE = Rozet met 90° rand
- RVS cirkel geborsteld
- Kunststof onderconstructie met geïntegreerde veer



- SE = Rosace avec 90° bord
- Inox brossé circulaire
- Sous-construction nylon avec ressort de retenue



- SE = Rosette mit 90° Rand
- Edelstahl kreisförmig gebürstet
- Kunststoff Unterkonstruktion mit integrierter Hochhaltefeder



- SE = Rose with 90° edge
- Circle brushed stainless steel
- Nylon understructure with integrated spring



		00981
		00982



		8 mm	00983



	2R30.SE
--	---------



	2R31.SE
--	---------



	2R32.SE
--	---------



	6/7 mm	2R30.T67.SE
	8 mm	2R30.T8.SE



	Paar / Paire Paar / Pair	00970
--	-----------------------------	-------

Combineerbaar met / A combiner avec
Kombinierbar mit / Combine with

	Schild / Plaque / Schild / Plate	255
--	----------------------------------	-----

Lana FR

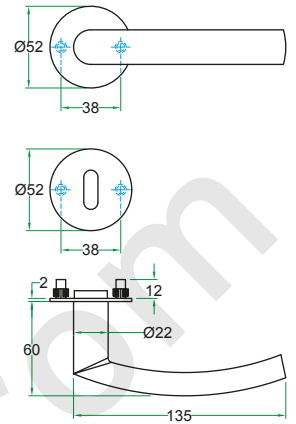

3D

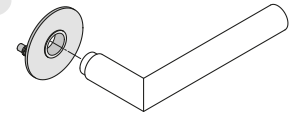
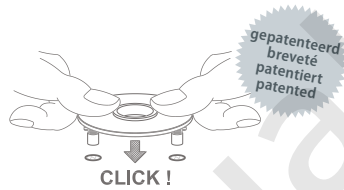

- FR = 2 mm vlakrozet
- Rozetmontage zonder schroeven
- Minimalistische uitstraling
- Zonder veer



- FR = Rosace plate 2 mm
- Montage de la rosace sans vis
- Radiation minimaliste
- Sans ressort de retenue



- FR = 2 mm Flachrosette
- Montage der Rosette ohne Schrauben
- Minimalistische Ausstrahlung
- Ohne Hochhaltefeder



- FR = 2 mm flat rose
- Assembly without screws
- Minimalistic look
- Unsprung



		00991
		00992



			8 mm	00993
--	--	--	------	-------

04101	04106	04107

	6/7 mm	04112/T67
	8 mm	04112/T8

	Paar / Paire Paar / Pair	00970
--	-----------------------------	-------

→ Combineerbaar met / A combiner avec
Kombinierbar mit / Combine with →

	Schild / Plaque / Schild / Plate	255
--	----------------------------------	-----

Lana FS

3D

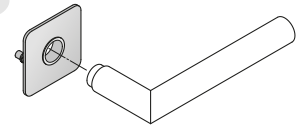
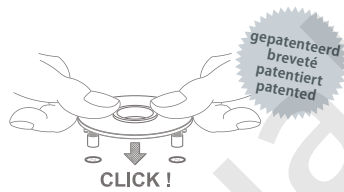
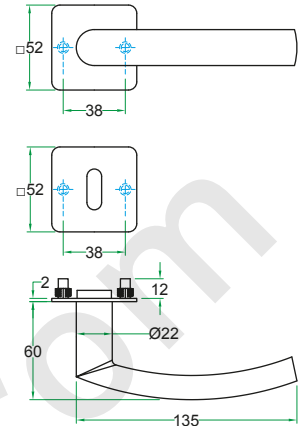

- FS = 2 mm vlakrozet
- Rozetmontage zonder schroeven
- Minimalistische uitstraling
- Zonder veer



- FS = Rosace plate 2 mm
- Montage de la rosace sans vis
- Radiation minimaliste
- Sans ressort de retenue



- FS = 2 mm Flachrosette
- Montage der Rosette ohne Schrauben
- Minimalistische Ausstrahlung
- Ohne Hochhaltefeder



- FS = 2 mm flat rose
- Assembly without screws
- Minimalistic look
- Unsprung



		01111
		01112



		8 mm	01113



	04201
--	-------



	04206
--	-------



	04207
--	-------



	6/7 mm	04212/T67
	8 mm	04212/T8

	Paar / Paire Paar / Pair	00970
--	-----------------------------	-------

Combineerbaar met / A combiner avec
Kombinierbar mit / Combine with

	Schild / Plaque / Schild / Plate	255
--	----------------------------------	-----

Laura

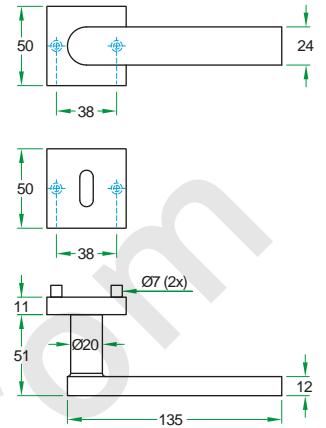

3D

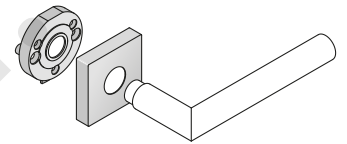

- RVS mat geborsteld
- Kunststof onderconstructie met geïntegreerde veer



- Inox mat brossé
- Sous-structure nylon avec ressort de retenue



- Edelstahl matt gebürstet
- Kunststoff Unterkonstruktion mit integrierter Hochhaltefeder



- Satin stainless steel
- Nylon understructure with integrated spring

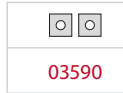
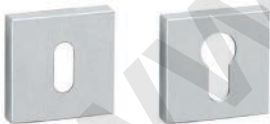

03590

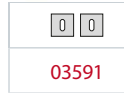

03591

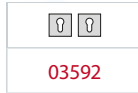

03592



6/7 mm

03596

8 mm

03594

		00921
		00922

		8 mm	00923
--	--	------	-------

	6/7 mm	03596
	8 mm	03594

	Paar / Paire Paar / Pair	00900
--	-----------------------------	-------

Combineerbaar met / A combiner avec
Kombinierbar mit / Combine with

	Schild / Plaque / Schild / Plate		255
--	----------------------------------	--	-----

Laura SE

3D

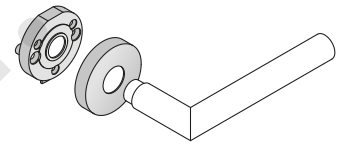
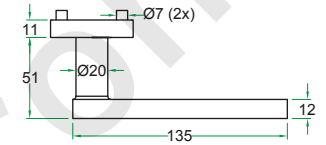
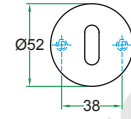
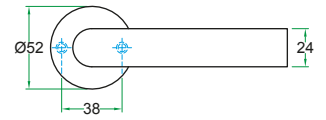
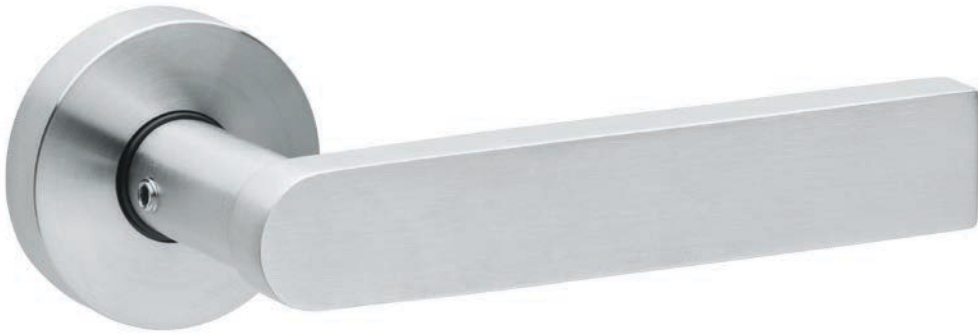

- SE = Rozet met 90° rand
- RVS cirkel geborsteld
- Kunststof onderconstructie met geïntegreerde veer



- SE = Rosace avec 90° bord
- Inox brossé circulaire
- Sous-construction nylon avec ressort de retenue



- SE = Rosette mit 90° Rand
- Edelstahl kreisförmig gebürstet
- Kunststoff Unterkonstruktion mit integrierter Hochhaltefeder



- SE = Rose with 90° edge
- Circle brushed stainless steel
- Nylon understructure with integrated spring

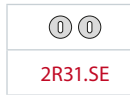

		01251
		01252

		8 mm	01253
--	--	------	-------

	6/7 mm	2R30.T67.SE
	8 mm	2R30.T8.SE

	Paar / Paire Paar / Pair	00900
--	-----------------------------	-------

Combineerbaar met / A combiner avec
Kombinierbar mit / Combine with

	Schild / Plaque / Schild / Plate	255
--	----------------------------------	-----

Laura FS

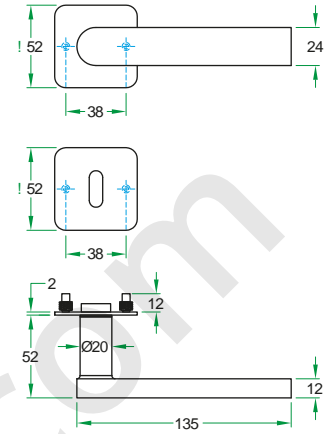

3D

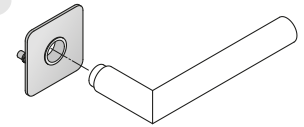
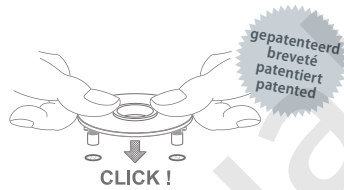

- FS = 2 mm vlakrozet
- Rozetmontage zonder schroeven
- Minimalistische uitstraling
- Zonder veer



- FS = Rosace plate 2 mm
- Montage de la rosace sans vis
- Radiation minimaliste
- Sans ressort de retenue



- FS = 2 mm Flachrosette
- Montage der Rosette ohne Schrauben
- Minimalistische Ausstrahlung
- Ohne Hochhaltefeder



- FS = 2 mm flat rose
- Assembly without screws
- Minimalistic look
- Unsprung



04201	04206	04207

		00901
		00902

		8 mm	00903
--	--	------	-------

	6/7 mm	04212/T67
	8 mm	04212/T8

	Paar / Paire Paar / Pair	00900
--	-----------------------------	-------

Combineerbaar met / A combiner avec
Kombinierbar mit / Combine with

	Schild / Plaque / Schild / Plate		255
--	----------------------------------	--	-----

Lido

3D

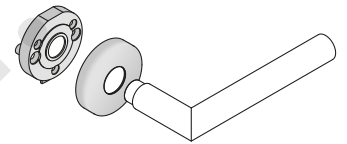
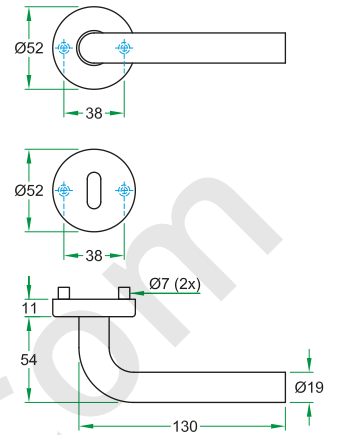

- RVS mat geborsteld
- Kunststof onderconstructie met geïntegreerde veer



- Inox mat brossé
- Sous-structure nylon avec ressort de retenue



- Edelstahl matt gebürstet
- Kunststoff Unterkonstruktion mit integrierter Hochhaltefeder



- Satin stainless steel
- Nylon understructure with integrated spring



	⓪ ⓪	00101-WCX
	⓪ ⓪	00102-WCX



	⓪ ⊖	8 mm	00103-WCX
--	-----	------	-----------



⓪ ⊖	2R10.WCX
-----	----------



⓪ ⓪	2R11.WCX
-----	----------



⓪ ⓪	2R12.WCX
-----	----------



⓪ ⊖	6/7 mm	2R10.T67.WCX
	8 mm	2R10.T8.WCX

	Paar / Paire Paar / Pair	00100-WCX
--	-----------------------------	-----------

Combineerbaar met / A combiner avec
Kombinierbar mit / Combine with

	Schild / Plaque / Schild / Plate	255
--	----------------------------------	-----

Metro

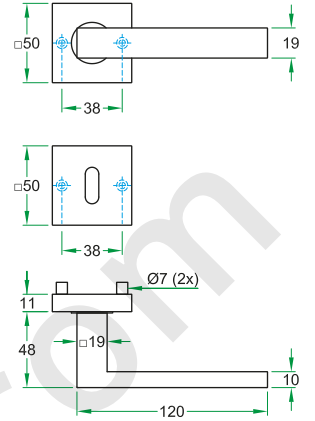
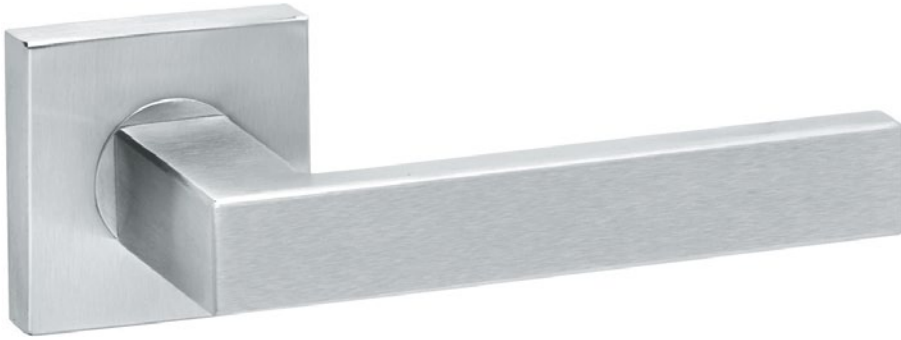

3D

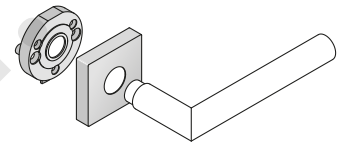

- RVS mat geborsteld
- Kunststof onderconstructie met geïntegreerde veer



- Inox mat brossé
- Sous-structure nylon avec ressort de retenue



- Edelstahl matt gebürstet
- Kunststoff Unterkonstruktion mit integrierter Hochhaltefeder



- Satin stainless steel
- Nylon understructure with integrated spring

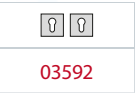
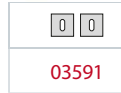
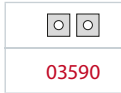
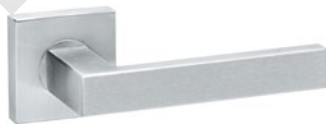
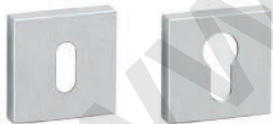
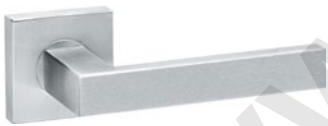

		03241
		03242

		8 mm	03243
--	--	------	-------

	6/7 mm	03596
	8 mm	03594

Pipo

3D

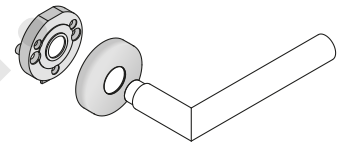
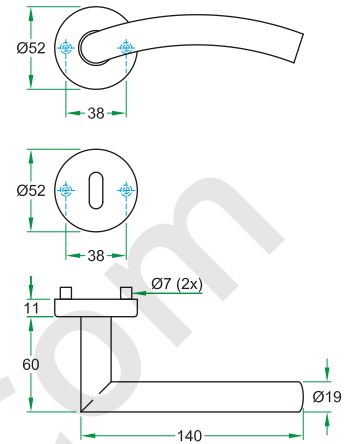

- RVS mat geborsteld
- Kunststof onderconstructie met geïntegreerde veer



- Inox mat brossé
- Sous-structure nylon avec ressort de retenue



- Edelstahl matt gebürstet
- Kunststoff Unterkonstruktion mit integrierter Hochhaltefeder



- Satin stainless steel
- Nylon understructure with integrated spring

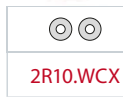

2R10.WCX

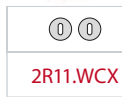

2R11.WCX

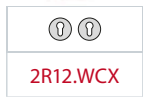

2R12.WCX

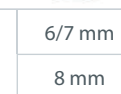

6/7 mm

8 mm

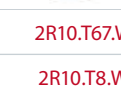

2R10.T67.WCX

2R10.T8.WCX



⓪ ⓪

00141-WCX

⓪ ⓪

00142-WCX

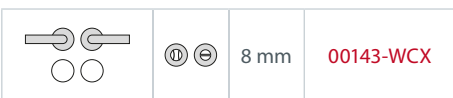

⓪ ⊖

8 mm

00143-WCX

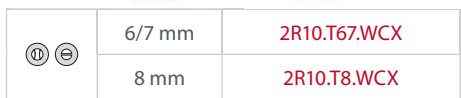

⓪ ⊖

6/7 mm

8 mm

2R10.T67.WCX

2R10.T8.WCX



Paar / Paire
Paar / Pair

00140-WCX

Combineerbaar met / A combiner avec
Kombinierbar mit / Combine with



Schild / Plaque / Schild / Plate

255

Polo

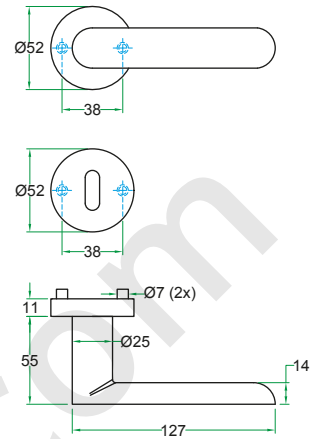
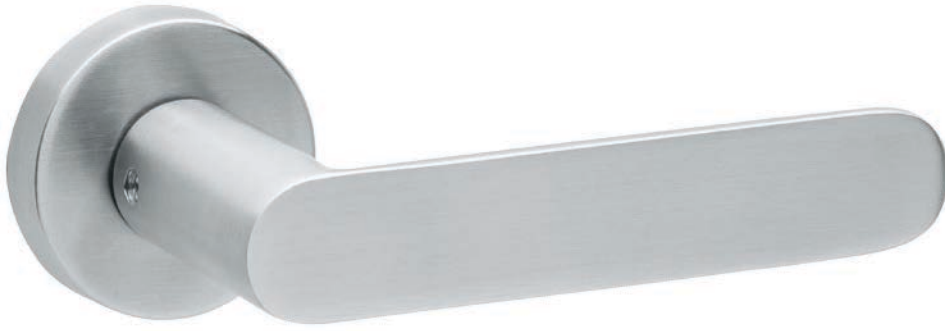

3D



- RVS mat geborsteld
- Kunststof onderconstructie met geïntegreerde veer



- Inox mat brossé
- Sous-structure nylon avec ressort de retenue



- Edelstahl matt gebürstet
- Kunststoff Unterkonstruktion mit integrierter Hochhaltefeder



- Satin stainless steel
- Nylon understructure with integrated spring



2R10.WCX

2R11.WCX

2R12.WCX



Ⓜ Ⓜ

6/7 mm

2R10.T67.WCX

8 mm

2R10.T8.WCX

	Ⓜ Ⓜ	00941
	Ⓜ Ⓜ	00942

	Ⓜ Ⓜ	8 mm	00943
--	-----	------	-------

	Paar / Paire Paar / Pair	00940
--	-----------------------------	-------

Combineerbaar met / A combiner avec
Kombinierbar mit / Combine with

	Schild / Plaque / Schild / Plate	255
--	----------------------------------	-----

Polo SE

3D

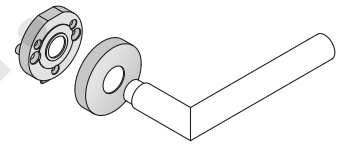
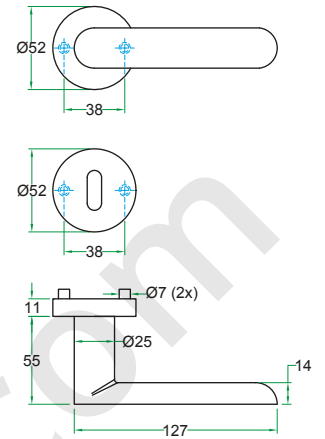

- SE = Rozet met 90° rand
- RVS cirkel geborsteld
- Kunststof onderconstructie met geïntegreerde veer



- SE = Rosace avec 90° bord
- Inox brossé circulaire
- Sous-construction nylon avec ressort de retenue



- SE = Rosette mit 90° Rand
- Edelstahl kreisförmig gebürstet
- Kunststoff Unterkonstruktion mit integrierter Hochhaltefeder



- SE = Rose with 90° edge
- Circle brushed stainless steel
- Nylon understructure with integrated spring

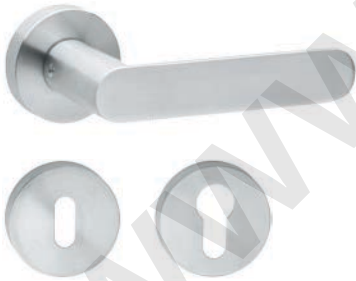

	⓪ ⓪	00951
	⓪ ⓪	00952

	⓪ ⊖	8 mm	00953
--	-----	------	-------

	6/7 mm	2R30.T67.SE
	8 mm	2R30.T8.SE

	Paar / Paire Paar / Pair	00940
--	-----------------------------	-------

Combineerbaar met / A combiner avec
Kombinierbar mit / Combine with

	Schild / Plaque / Schild / Plate		255
--	----------------------------------	--	-----

Polo FR

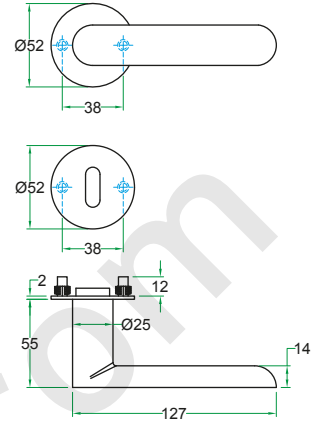
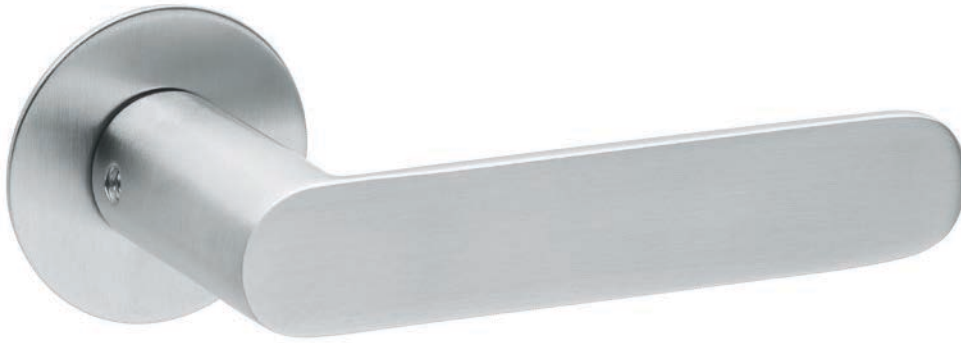

3D

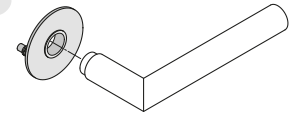
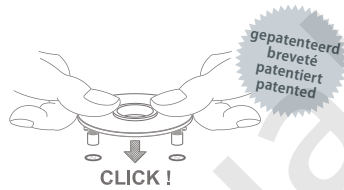

- FR = 2 mm vlakrozet
- Rozetmontage zonder schroeven
- Minimalistische uitstraling
- Zonder veer



- FR = Rosace plate 2 mm
- Montage de la rosace sans vis
- Radiation minimaliste
- Sans ressort de retenue



- FR = 2 mm Flachrosette
- Montage der Rosette ohne Schrauben
- Minimalistische Ausstrahlung
- Ohne Hochhaltefeder



- FR = 2 mm flat rose
- Assembly without screws
- Minimalistic look
- Unsprung



			00961
			00962

			8 mm	00963
--	--	--	------	-------

	6/7 mm	04112/T67
	8 mm	04112/T8

	Paar / Paire Paar / Pair	00940
--	-----------------------------	-------

→ Combineerbaar met / A combiner avec
Kombinierbar mit / Combine with →

	Schild / Plaque / Schild / Plate		255
--	----------------------------------	--	-----

Polo FS

3D

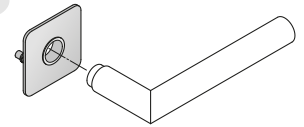
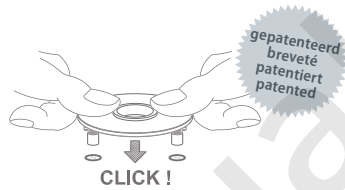
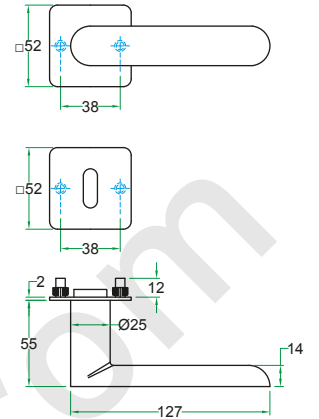
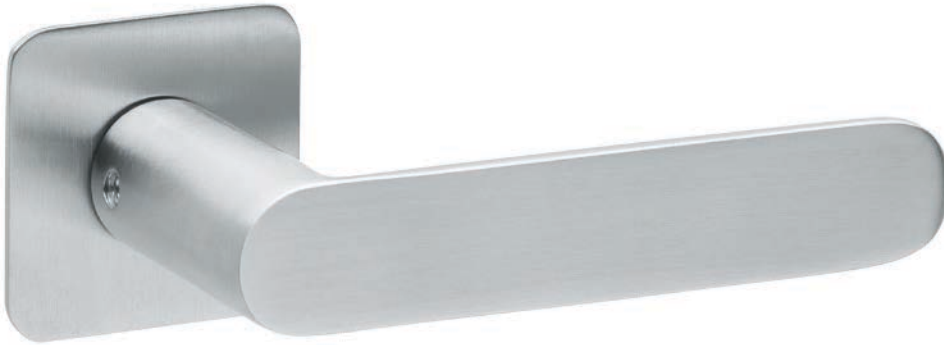

- FS = 2 mm vlakrozet
- Rozetmontage zonder schroeven
- Minimalistische uitstraling
- Zonder veer



- FS = Rosace plate 2 mm
- Montage de la rosace sans vis
- Radiation minimaliste
- Sans ressort de retenue



- FS = 2 mm Flachrosette
- Montage der Rosette ohne Schrauben
- Minimalistische Ausstrahlung
- Ohne Hochhaltefeder



- FS = 2 mm flat rose
- Assembly without screws
- Minimalistic look
- Unsprung



		01231
		01232



		8 mm	01233
--	--	------	-------



	04201
--	-------



	04206
--	-------



	04207
--	-------



	6/7 mm	04212/T67
	8 mm	04212/T8

	Paar / Paire Paar / Pair	00940
--	-----------------------------	-------

Combineerbaar met / A combiner avec
Kombinierbar mit / Combine with

	Schild / Plaque / Schild / Plate	255
--	----------------------------------	-----

Primo

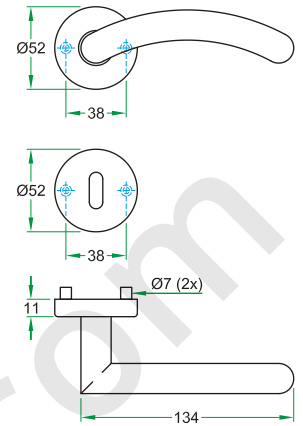

3D



- RVS mat geborsteld
- Kunststof onderconstructie met geïntegreerde veer



- Inox mat brossé
- Sous-structure nylon avec ressort de retenue



- Edelstahl matt gebürstet
- Kunststoff Unterkonstruktion mit integrierter Hochhaltefeder



- Satin stainless steel
- Nylon understructure with integrated spring



		00891-WCX
		00892-WCX

		8 mm	00893-WCX
--	--	------	-----------

	6/7 mm	2R10.T67.WCX
	8 mm	2R10.T8.WCX

	Paar / Paire Paar / Pair	00890-WCX
--	-----------------------------	-----------

Combineerbaar met / A combiner avec
Kombinierbar mit / Combine with

	Schild / Plaque / Schild / Plate	255
--	----------------------------------	-----

Saba

3D

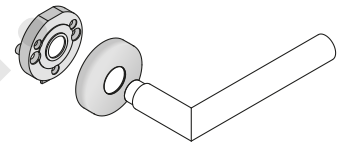
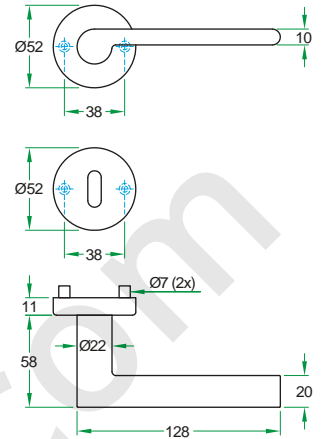

- RVS mat geborsteld
- Kunststof onderconstructie met geïntegreerde veer



- Inox mat brossé
- Sous-structure nylon avec ressort de retenue



- Edelstahl matt gebürstet
- Kunststoff Unterkonstruktion mit integrierter Hochhaltefeder



- Satin stainless steel
- Nylon understructure with integrated spring



2R10.WCX



2R11.WCX



2R12.WCX



⓪ ⓪

00931

⓪ ⓪

00932



⓪ ⊖

8 mm

00933

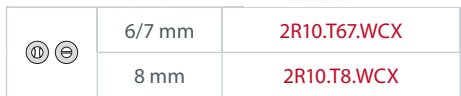

⓪ ⊖

6/7 mm

2R10.T67.WCX

8 mm

2R10.T8.WCX



Paar / Paire
Paar / Pair

00910

→ Combineerbaar met / A combiner avec
Kombinierbar mit / Combine with →

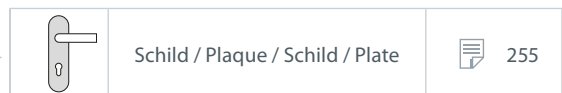

Schild / Plaque / Schild / Plate

255

Saba SE

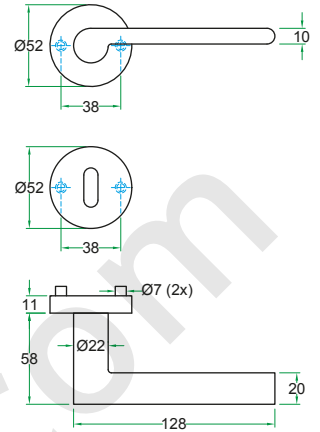

3D

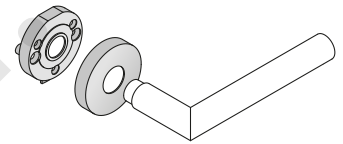

- SE = Rozet met 90° rand
- RVS cirkel geborsteld
- Kunststof onderconstructie met geïntegreerde veer



- SE = Rosace avec 90° bord
- Inox brossé circulaire
- Sous-construction nylon avec ressort de retenue



- SE = Rosette mit 90° Rand
- Edelstahl kreisförmig gebürstet
- Kunststoff Unterkonstruktion mit integrierter Hochhaltefeder



- SE = Rose with 90° edge
- Circle brushed stainless steel
- Nylon understructure with integrated spring



	⓪ ⓪	01241
	⓪ ⓪	01242

	⓪ ⊖	8 mm	01243
--	-----	------	-------

	6/7 mm	2R30.T67.SE
	8 mm	2R30.T8.SE

	Paar / Paire Paar / Pair	00910
--	-----------------------------	-------

Combineerbaar met / A combiner avec
Kombinierbar mit / Combine with

	Schild / Plaque / Schild / Plate	255
--	----------------------------------	-----

Saba FR

3D

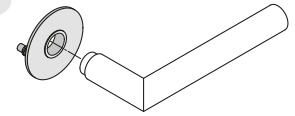
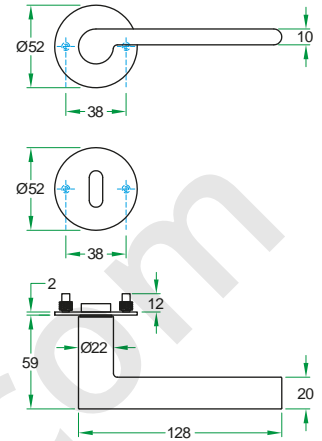

- FR = 2 mm vlakrozet
- Rozetmontage zonder schroeven
- Minimalistische uitstraling
- Zonder veer



- FR = Rosace plate 2 mm
- Montage de la rosace sans vis
- Radiation minimaliste
- Sans ressort de retenue



- FR = 2 mm Flachrosette
- Montage der Rosette ohne Schrauben
- Minimalistische Ausstrahlung
- Ohne Hochhaltefeder



- FR = 2 mm flat rose
- Assembly without screws
- Minimalistic look
- Unsprung



		00911
		00912



		8 mm	00913
--	--	------	-------

04101	04106	04107

	6/7 mm	04112/T67
	8 mm	04112/T8

	Paar / Paire Paar / Pair	00910
--	-----------------------------	-------

Combineerbaar met / A combiner avec
Kombinierbar mit / Combine with

	Schild / Plaque / Schild / Plate	255
--	----------------------------------	-----

Sabrina

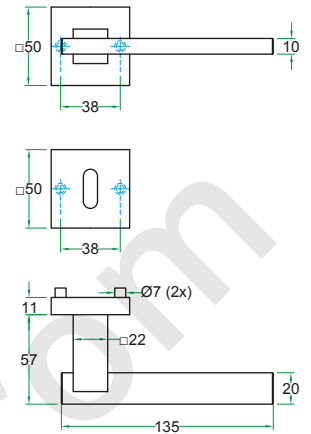
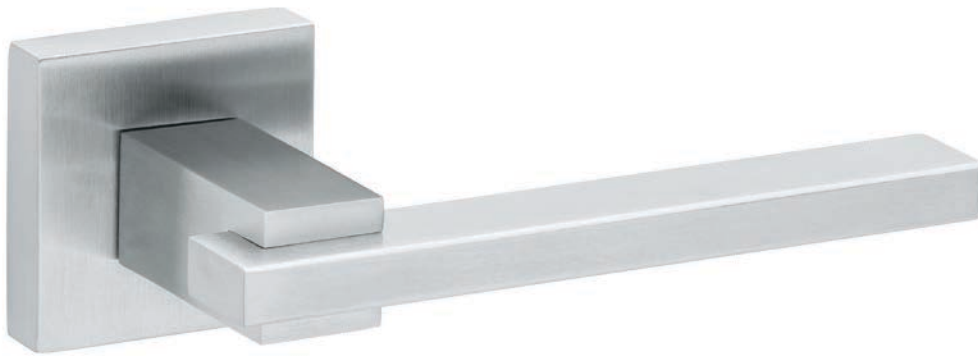

3D

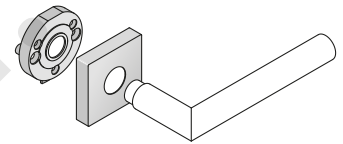

- RVS mat geborsteld
- Kunststof onderconstructie met geïntegreerde veer



- Inox mat brossé
- Sous-structure nylon avec ressort de retenue



- Edelstahl matt gebürstet
- Kunststoff Unterkonstruktion mit integrierter Hochhaltefeder



- Satin stainless steel
- Nylon understructure with integrated spring

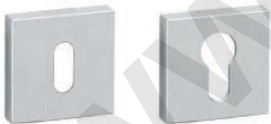
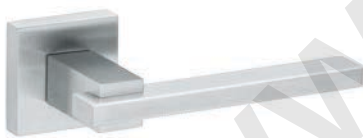

		00511
		00512



		8 mm	00513
--	--	------	-------



	03590
--	-------



	03591
--	-------



	03592
--	-------



	6/7 mm	03596
	8 mm	03594



	03596
	03594

	Paar / Paire Paar / Pair	00510
--	-----------------------------	-------

Combineerbaar met / A combiner avec
Kombinierbar mit / Combine with

	Schild / Plaque / Schild / Plate	255
--	----------------------------------	-----

Sabrina FS

3D

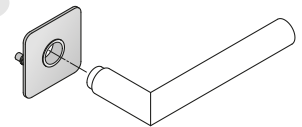
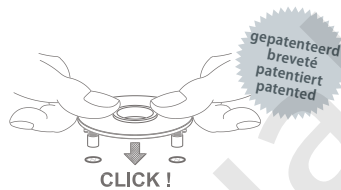
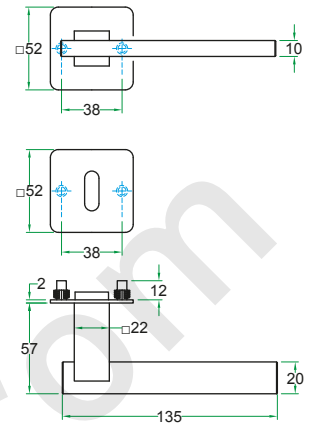
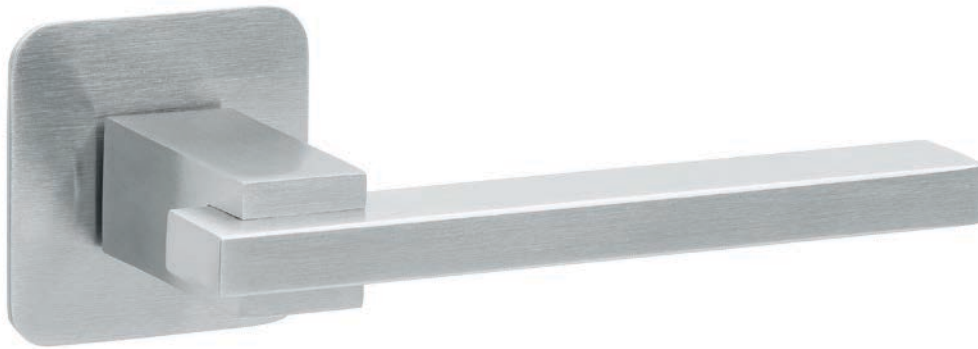

- FS = 2 mm vlakrozet
- Rozetmontage zonder schroeven
- Minimalistische uitstraling
- Zonder veer



- FS = Rosace plate 2 mm
- Montage de la rosace sans vis
- Radiation minimaliste
- Sans ressort de retenue



- FS = 2 mm Flachrosette
- Montage der Rosette ohne Schrauben
- Minimalistische Ausstrahlung
- Ohne Hochhaltefeder



- FS = 2 mm flat rose
- Assembly without screws
- Minimalistic look
- Unsprung

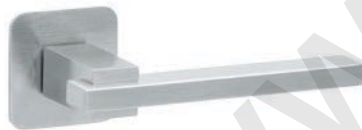

		00561
		00562

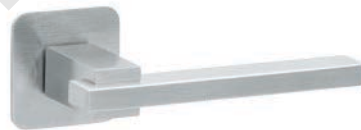

		8 mm	00563



	04201
--	-------



	04206
--	-------



	04207
--	-------



	6/7 mm	04212/T67
	8 mm	04212/T8

	Paar / Paire Paar / Pair	00510
--	-----------------------------	-------

Combineerbaar met / A combiner avec
Kombinierbar mit / Combine with

	Schild / Plaque / Schild / Plate		255
--	----------------------------------	--	-----

Sipo

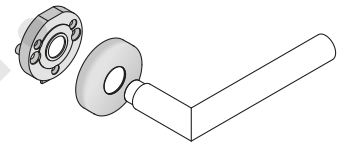
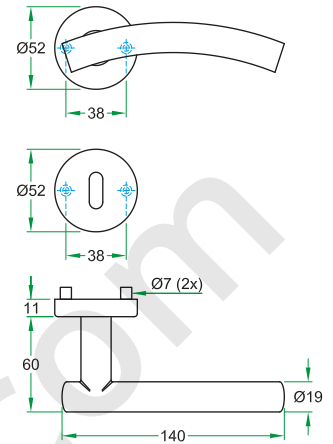

3D



- RVS mat geborsteld
- Kunststof onderconstructie met geïntegreerde veer



- Inox mat brossé
- Sous-construction nylon avec ressort de retenue



- Edelstahl matt gebürstet
- Kunststoff Unterkonstruktion mit integrierter Hochhaltefeder



- Satin stainless steel
- Nylon understructure with integrated spring



		00151-WCX
		00152-WCX

		8 mm	00153-WCX
--	--	------	-----------

	6/7 mm	2R10.T67.WCX
	8 mm	2R10.T8.WCX

Tec

3D

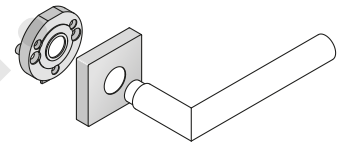
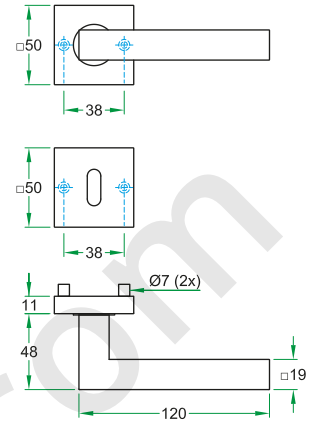
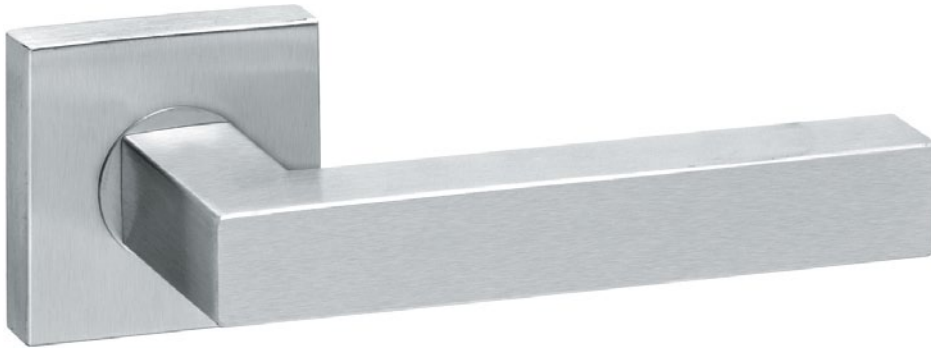

- RVS mat geborsteld
- Kunststof onderconstructie met geïntegreerde veer



- Inox mat brossé
- Sous-construction nylon avec ressort de retenue



- Edelstahl matt gebürstet
- Kunststoff Unterkonstruktion mit integrierter Hochhaltefeder



- Satin stainless steel
- Nylon understructure with integrated spring

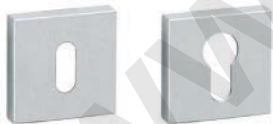

6/7 mm

03596

8 mm

03594

		03221
		03222

		8 mm	03223
--	--	------	-------

Tipo

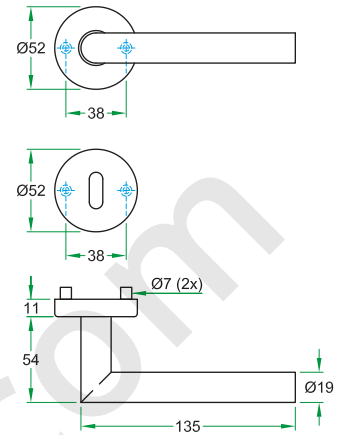

3D



- RVS mat geborsteld
- Kunststof onderconstructie met geïntegreerde veer



- Inox mat brossé
- Sous-structure nylon avec ressort de retenue



- Edelstahl matt gebürstet
- Kunststoff Unterkonstruktion mit integrierter Hochhaltefeder



- Satin stainless steel
- Nylon understructure with integrated spring



	① ①	00121-WCX
	② ②	00122-WCX

	③ ④	8 mm	00123-WCX
--	-----	------	-----------

	6/7 mm	2R10.T67.WCX
	8 mm	2R10.T8.WCX

	Paar / Paire Paar / Pair	00120-WCX
--	-----------------------------	-----------

Combineerbaar met / A combiner avec
Kombinierbar mit / Combine with

	Schild / Plaque / Schild / Plate	255
--	----------------------------------	-----

Tipo SQ

3D

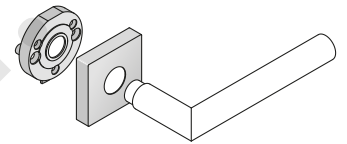
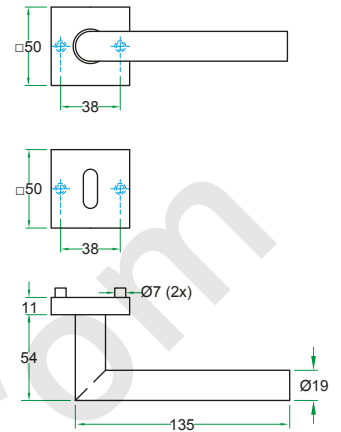

- RVS mat geborsteld
- Kunststof onderconstructie met geïntegreerde veer



- Inox mat brossé
- Sous-structure nylon avec ressort de retenue



- Edelstahl matt gebürstet
- Kunststoff Unterkonstruktion mit integrierter Hochhaltefeder



- Satin stainless steel
- Nylon understructure with integrated spring

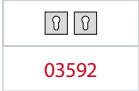
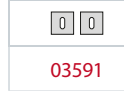
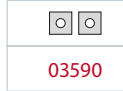
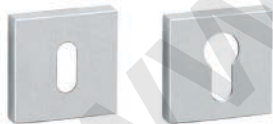

		00121-SQ
		00122-SQ

		8 mm	00123-SQ
--	--	------	----------

	6/7 mm	03596
	8 mm	03594

	Paar / Paire Paar / Pair	00120-WCX
--	-----------------------------	-----------

Combineerbaar met / A combiner avec
Kombinierbar mit / Combine with

	Schild / Plaque / Schild / Plate		255
--	----------------------------------	--	-----

Tipo FR

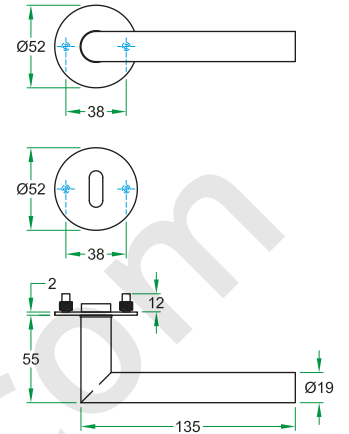

3D

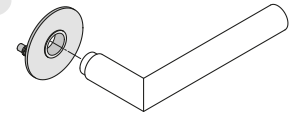
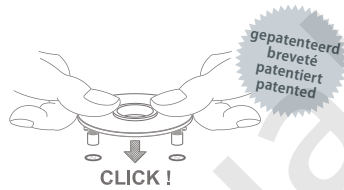

- FR = 2 mm vlakrozet
- RVS mat geborsteld
- Rozetmontage zonder schroeven
- Minimalistische uitstraling
- Zonder veer



- FR = Rosace plate 2 mm
- Inox mat brossé
- Montage de la rosace sans vis
- Radiation minimaliste
- Sans ressort de retenue



- FR = 2 mm Flachrosette
- Edelstahl matt gebürstet
- Montage der Rosette ohne Schrauben
- Minimalistische Ausstrahlung
- Ohne Hochhaltefeder



- FR = 2 mm flat rose
- Satin stainless steel
- Assembly without screws
- Minimalistic look
- Unsprung



		04051
		04052

		8 mm	04053
--	--	------	-------

	6/7 mm	04112/T67
	8 mm	04112/T8

Tipo FRP

3D

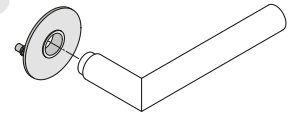
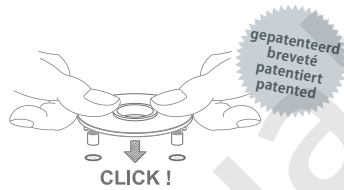
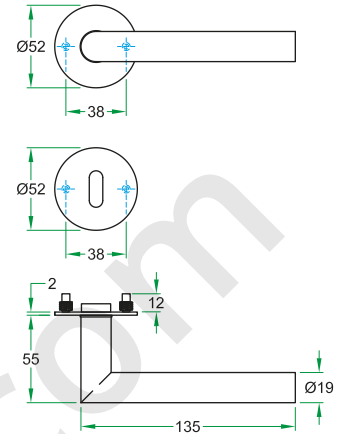

- FRP = 2 mm vlakrozet
- RVS gepolijst
- Rozetmontage zonder schroeven
- Minimalistische uitstraling
- Zonder veer



- FRP = Rosace plate 2 mm
- Inox poli
- Montage de la rosace sans vis
- Radiation minimaliste
- Sans ressort de retenue



- FRP = 2 mm Flachrosette
- Edelstahl poliert
- Montage der Rosette ohne Schrauben
- Minimalistische Ausstrahlung
- Ohne Hochhaltefeder



- FRP = 2 mm flat rose
- Polished stainless steel
- Assembly without screws
- Minimalistic look
- Unsprung

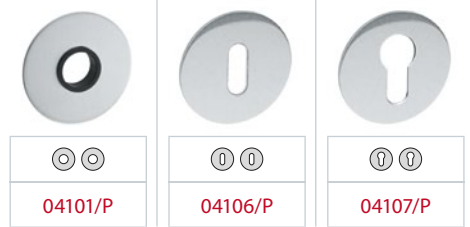

	⓪ ⓪	04051/P
	⓪ ⓪	04052/P

	⓪ ⊕	8 mm	04053/P
--	-----	------	---------

	6/7 mm	04112P/T67
	8 mm	04112P/T8

Tipo FS

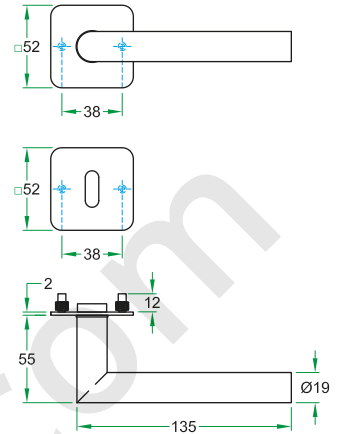

3D

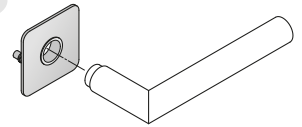
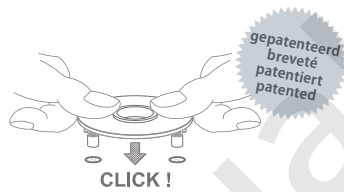

- FS = 2 mm vlakrozet
- RVS mat geborsteld
- Rozetmontage zonder schroeven
- Minimalistische uitstraling
- Zonder veer



- FS = Rosace plate 2 mm
- Inox mat brossé
- Montage de la rosace sans vis
- Radiation minimaliste
- Sans ressort de retenue



- FS = 2 mm Flachrosette
- Edelstahl matt gebürstet
- Montage der Rosette ohne Schrauben
- Minimalistische Ausstrahlung
- Ohne Hochhaltefeder



- FS = 2 mm flat rose
- Satin stainless steel
- Assembly without screws
- Minimalistic look
- Unsprung

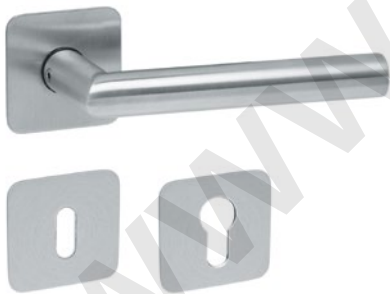

		04061
		04062

		8 mm	04063

	6/7 mm	04212/T67
	8 mm	04212/T8

Tipo FSP

3D

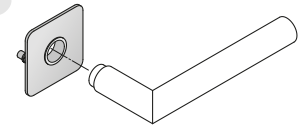
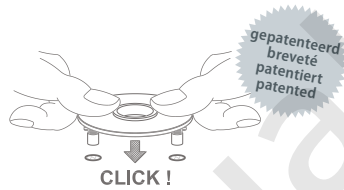
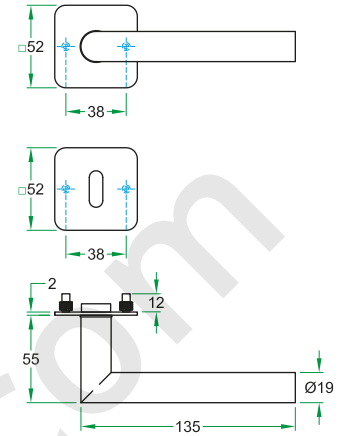

- FSP = 2 mm vlakrozet
- RVS gepolijst
- Rozetmontage zonder schroeven
- Minimalistische uitstraling
- Zonder veer



- FSP = Rosace plate 2 mm
- Inox poli
- Montage de la rosace sans vis
- Radiation minimaliste
- Sans ressort de retenue



- FSP = 2 mm Flachrosette
- Edelstahl poliert
- Montage der Rosette ohne Schrauben
- Minimalistische Ausstrahlung
- Ohne Hochhaltefeder



- FSP = 2 mm flat rose
- Polished stainless steel
- Assembly without screws
- Minimalistic look
- Unsprung



04201/P



04206/P



04207/P

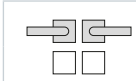

04061/P



04062/P

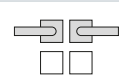

8 mm

04063/P



6/7 mm

04212P/T67

8 mm

04212P/T8

Uno

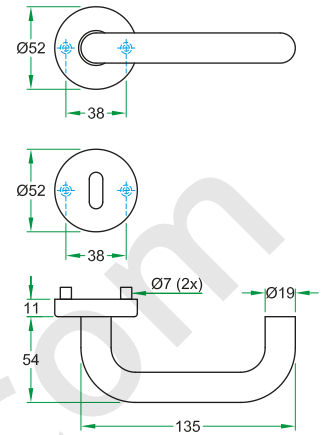
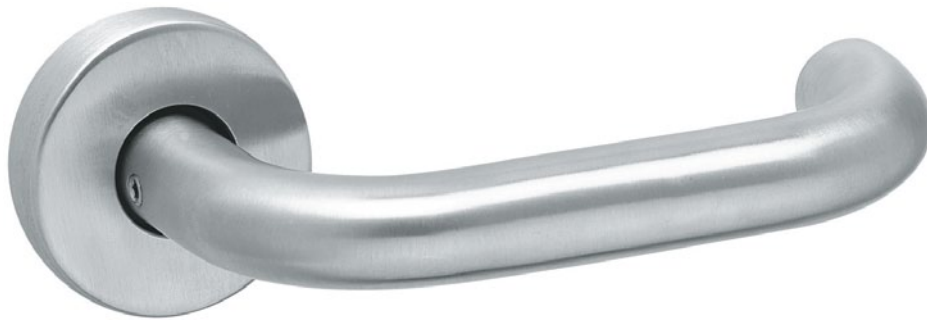

3D

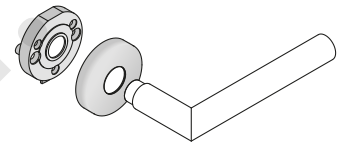

- RVS mat geborsteld
- Kunststof onderconstructie met geïntegreerde veer



- Inox mat brossé
- Sous-structure nylon avec ressort de retenue



- Edelstahl matt gebürstet
- Kunststoff Unterkonstruktion mit integrierter Hochhaltefeder



- Satin stainless steel
- Nylon understructure with integrated spring



		00111-WCX
		00112-WCX

		8 mm	00113-WCX
--	--	------	-----------

	6/7 mm	2R10.T67.WCX
	8 mm	2R10.T8.WCX

	Paar / Paire Paar / Pair	00110-WCX
--	-----------------------------	-----------

Combineerbaar met / A combiner avec
Kombinierbar mit / Combine with

	Schild / Plaque / Schild / Plate	255
--	----------------------------------	-----

Vogue

3D

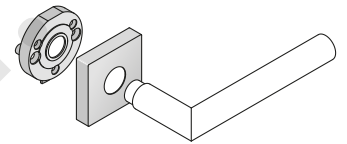
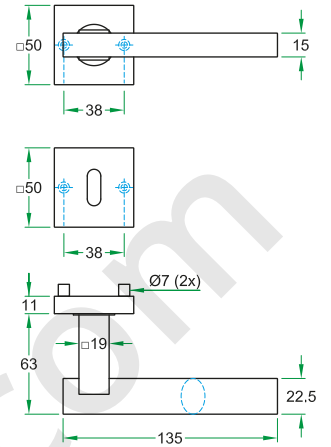
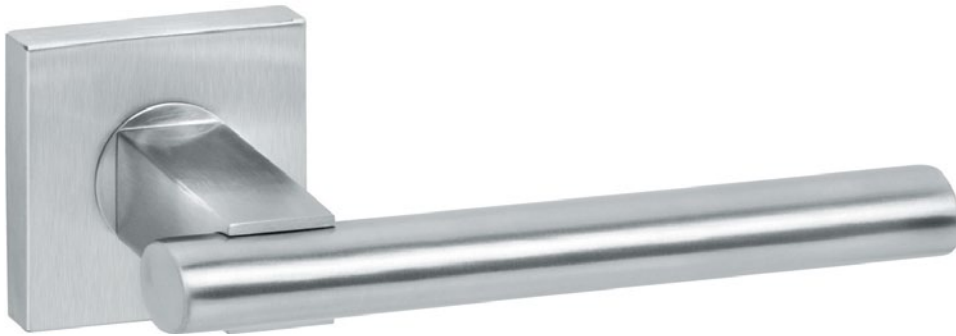

- RVS mat geborsteld
- Kunststof onderconstructie met geïntegreerde veer



- Inox mat brossé
- Sous-structure nylon avec ressort de retenue



- Edelstahl matt gebürstet
- Kunststoff Unterkonstruktion mit integrierter Hochhaltefeder



- Satin stainless steel
- Nylon understructure with integrated spring

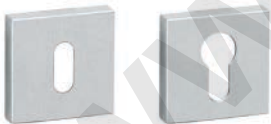

03590



03591



03592



6/7 mm

03596

8 mm

03594

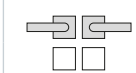

03341



03342

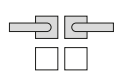

8 mm

03343

Wing

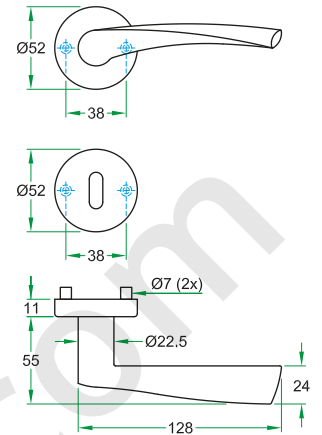

3D

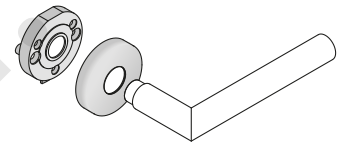

- RVS mat geborsteld
- Kunststof onderconstructie met geïntegreerde veer



- Inox mat brossé
- Sous-structure nylon avec ressort de retenue



- Edelstahl matt gebürstet
- Kunststoff Unterkonstruktion mit integrierter Hochhaltefeder



- Satin stainless steel
- Nylon understructure with integrated spring



2R10.WCX	2R11.WCX	2R12.WCX

		00851-WCX
		00852-WCX

		8 mm	00853-WCX
--	--	------	-----------

	6/7 mm	2R10.T67.WCX
	8 mm	2R10.T8.WCX

	Paar / Paire Paar / Pair	00850-WCX
--	-----------------------------	-----------

Combineerbaar met / A combiner avec
Kombinierbar mit / Combine with

	Schild / Plaque / Schild / Plate		255
--	----------------------------------	--	-----

COMPONENTEN / COMPOSANTS / ZUBEHÖR / COMPONENTS

Knop / Bouton / Knopf / Knob

3D

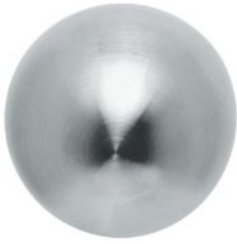

96181/R



- Draaibaar
- RVS mat geborsteld



- Tournant
- Inox mat brossé



- Drehbar
- Edelstahl matt gebürstet



- Turnable
- Brushed satin stainless steel

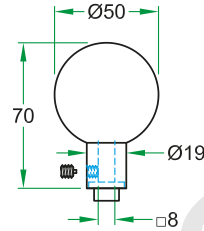

- Draaibaar
- RVS mat geborsteld



- Tournant
- Inox mat brossé



- Drehbar
- Edelstahl matt gebürstet



- Turnable
- Brushed satin stainless steel



96183/R

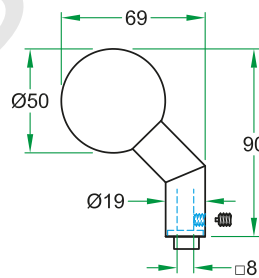

- Draaibaar
- RVS mat geborsteld



- Tournant
- Inox mat brossé



- Drehbar
- Edelstahl matt gebürstet



- Turnable
- Brushed satin stainless steel



67102/R

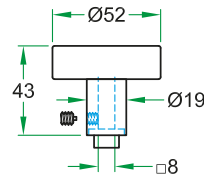

COMPONENTEN / COMPOSANTS / ZUBEHÖR / COMPONENTS

Knop / Bouton / Knopf / Knob



000KU



- Wisselknop op rozet
- RVS mat geborsteld
- Wisselstift M12/□8 x 80 mm



- Bouton fixe sur rosace
- Inox mat brossé
- Tige carrée M12/□8 x 80 mm



- Wechselknopf auf Rosette
- Edelstahl matt gebürstet
- Wechselstift M12/□8 x 80 mm



- Knob fixed on rose
- Brushed satin stainless steel
- Spindle M12/□8 x 80 mm

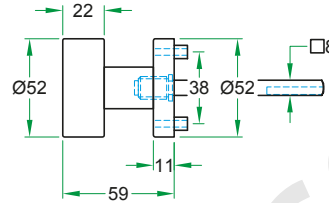

- Demontage sleutel voor 2 mm vlakrozet FR en FS



- Clef de demontage pour rosace plate 2 mm FR et FS



- Demontierschlüssel für 2 mm Flachrosette FR und FS



- Removal tool for 2 mm flat rose FR and FS



93108

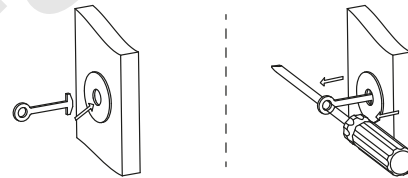

4 x 55 mm

Verlengde schroef / Vis allongée / Verlängerte Schraube / Extended screw

93235



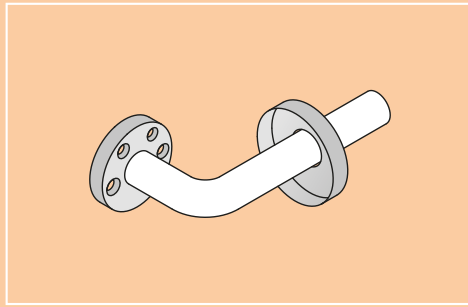

  Vastdraaibaar op rozet zonder nokken

  Fixe sur rosace sans cames

 Festdrehbar auf Rosette ohne Nocken

 Fixed with spring on rose without lugs



Vastdraaibaar op rozet zonder nokken
Fixe sur rosace sans cames
Festdrehbar auf Rosette ohne Nocken
Fixed with spring on rose without lugs

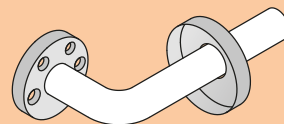

3E



Donna 239



Lima Ø 16 mm 240



Tria Ø 16 mm 242



Lita 241



Trio 243

Lima Ø 16 mm

3E

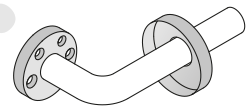
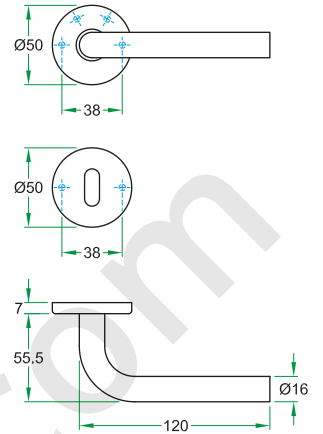

- RVS mat geborsteld
- Deurkruk Ø 16 mm vastdraaibaar met veer
- Stalen onderconstructie zonder nokken



- Inox mat brossé
- Béquille Ø 16 mm fixe avec ressort de retenue
- Sous-construction en acier sans cames



- Edelstahl matt gebürstet
- Drücker Ø 16 mm festdrehbar mit Hochhaltefeder
- Stahl Unterkonstruktion ohne Nocken



- Satin stainless steel
- Lever Ø 16 mm sprungloaded on rose
- Steel understructure without lugs



		W1031
		W1032

		8 mm	W1033
--	--	------	-------

W01	W02

8 mm	W03-T8
6/7 mm	W03-T67

8 mm	W03-T8RG

Lita

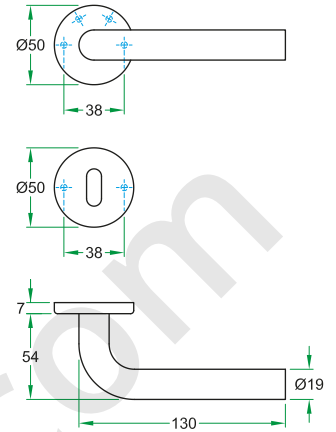

3E

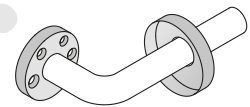

- RVS mat geborsteld
- Deurkruk vastdraaibaar met veer
- Stalen onderconstructie zonder nokken



- Inox mat brossé
- Béquille fixe avec ressort de retenue
- Sous-construction en acier sans cames



- Edelstahl matt gebürstet
- Drücker festdrehbar mit Hochhaltefeder
- Stahl Unterkonstruktion ohne Nocken



- Satin stainless steel
- Lever sprungloaded on rose
- Steel understructure without lugs



		W0901
		W0902

		8 mm	W0903
--	--	------	-------

W01	W02

8 mm	W03-T8
6/7 mm	W03-T67

8 mm	W03-T8RG

Tria Ø 16 mm

3E

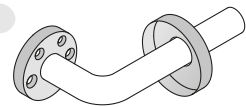
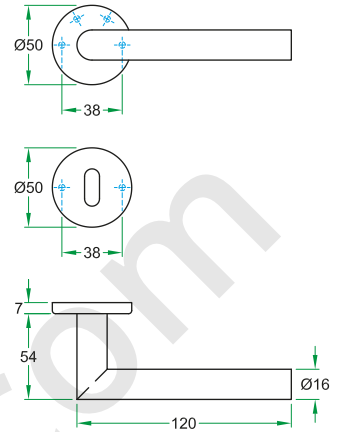

- RVS mat geborsteld
- Deurkruk Ø 16 mm vastdraaibaar met veer
- Stalen onderconstructie zonder nokken



- Inox mat brossé
- Béquille Ø 16 mm fixe avec ressort de retenue
- Sous-construction en acier sans cames



- Edelstahl matt gebürstet
- Drücker Ø 16 mm festdrehbar mit Hochhaltefeder
- Stahl Unterkonstruktion ohne Nocken



- Satin stainless steel
- Lever Ø 16 mm sprungloaded on rose
- Steel understructure without lugs



		W1051
		W1052

		8 mm	W1053
--	--	------	-------

W01	W02

8 mm	W03-T8
6/7 mm	W03-T67

8 mm	W03-T8RG

Trio

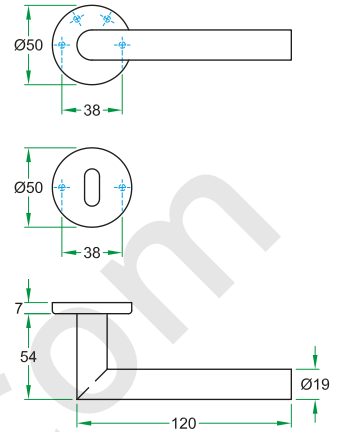

3E

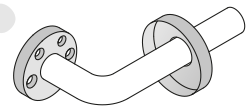

- RVS mat geborsteld
- Deurkruk vastdraaibaar met veer
- Stalen onderconstructie zonder nokken



- Inox mat brossé
- Béquille fixe avec ressort de retenue
- Sous-construction en acier sans cames



- Edelstahl matt gebürstet
- Drücker festdrehbar mit Hochhaltefeder
- Stahl Unterkonstruktion ohne Nocken



- Satin stainless steel
- Lever sprungloaded on rose
- Steel understructure without lugs



		W1011
		W1012

		8 mm	W1013
--	--	------	-------

W01	W02

8 mm	W03-T8
6/7 mm	W03-T67

8 mm	W03-T8RG

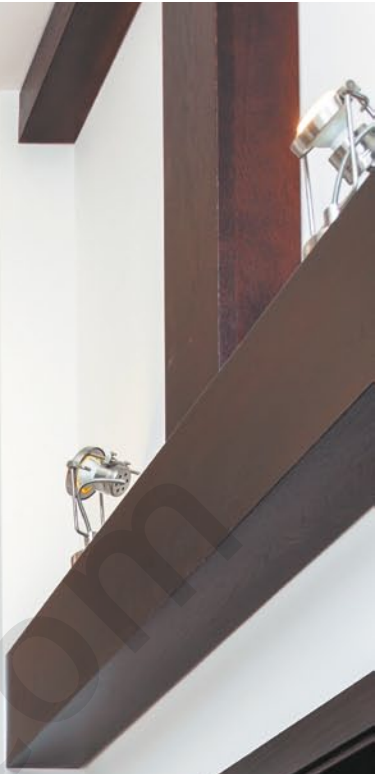

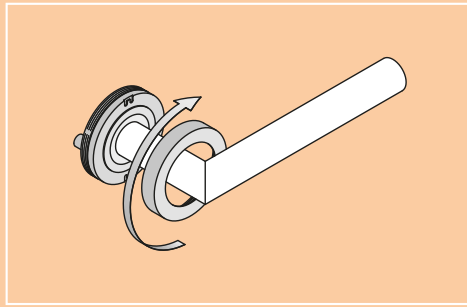

  Vastdraaibaar op schroefrozet

  Fixe sur rosace spirale

 Festschraubbar auf Überschraubrosette

 Fixed with spring on threaded rose

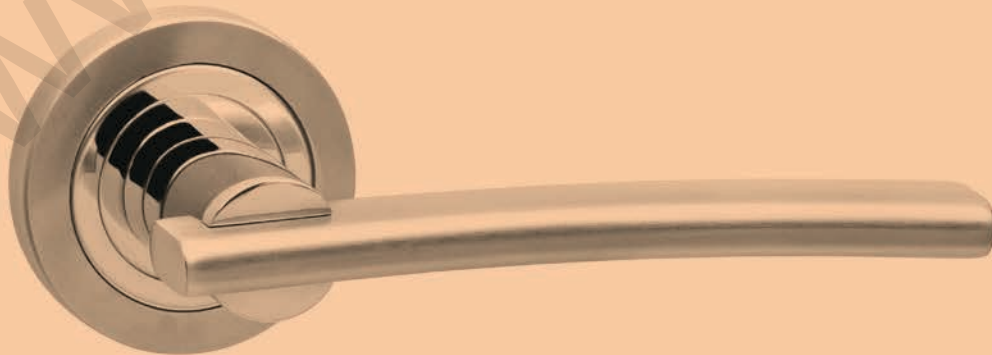

Vastdraaibaar op schroefrozet
 Fixe sur rosace spirale
 Festschraubbar auf Überschraubrossette
 Fixed with spring on threaded rose

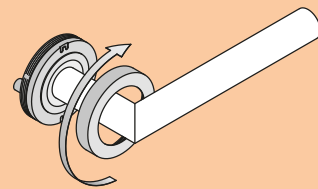

3F



Gino SC 247



Tipo SC 252



Uno SC 253



Dorina SC 248



Lalita SC 249

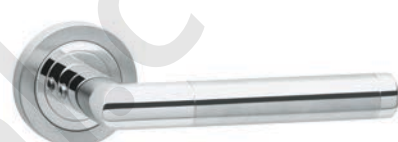

Space SC 251



Seville SC 250

Componenten / Composants / Zubehör / Components 254

Gino SC

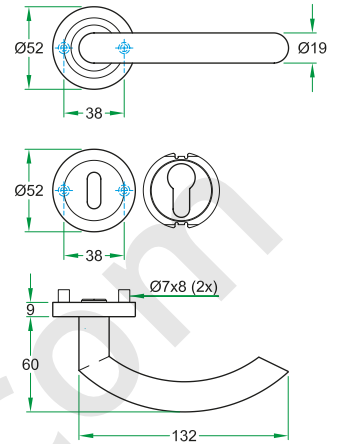

3F

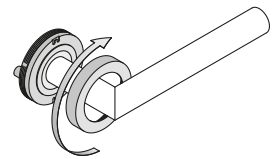

- SC = schroefrozet
- RVS deurkruk vastdraaibaar met dubbelwerkende veer op schroefrozet
- RVS mat geborsteld
- Zamac onderconstructie
- Geschikt voor meerpuntsluiting



- SC = Rosace spirale
- Béquille inox fixed avec ressort de retenue à double sens
- Inox at brossé
- Sous-construction en zamac
- Approprié pour serrures multipoints



- SC = Schraubrossette
- Edelstahl Drücker festdrehbar mit doppeltätigem Hochhaltefeder
- Edelstahl matt gebürstet
- Zink Druckguß Unterkonstruktion
- Geignet für Mehrfachverriegelung



- SC = screw rose
- Stainless steel lever sprungloaded with double working spring
- Satin stainless steel
- Zinc diecast understructure
- Suitable for multipoint locks

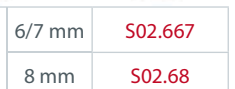
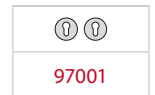
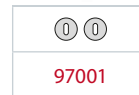

Dorina SC

3F

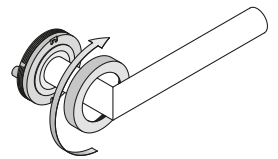
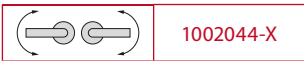
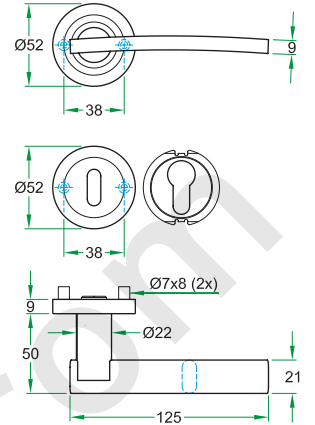

- SC = schroefrozet
- RVS deurkruk vastdraaibaar met dubbelwerkende veer op schroefrozet
- RVS gepolijst/mat geborsteld
- Zamac onderconstructie
- Geschikt voor meerpuntsluiting



- SC = Rosace spirale
- Béquille inox fixed avec ressort de retenue à double sens
- Inox poli/mat brossé
- Sous-construction en zamac
- Approprié pour serrures multipoints



- SC = Schraubrossette
- Edelstahl Drücker festdrehbar mit doppeltätigem Hochhaltefeder
- Edelstahl poliert/matt gebürstet
- Zink Druckguß Unterkonstruktion
- Geeignet für Mehrfachverriegelung



- SC = screw rose
- Stainless steel lever sprungloaded with double working spring
- Polished/satin stainless steel
- Zinc diecast understructure
- Suitable for multipoint locks



		1002044-23
		1002044-23

		8 mm	1002044-68
--	--	------	------------

97011	97011

6/7 mm	S12.667
8 mm	S12.68

Lalita SC

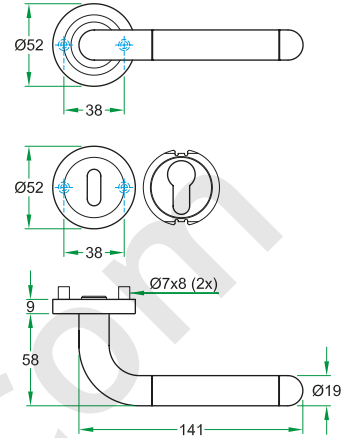

3F

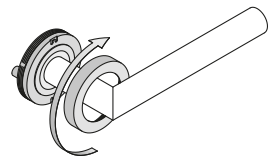

- SC = schroefrozet
- RVS deurkruk vastdraaibaar met dubbelwerkende veer op schroefrozet
- RVS gepolijst/mat geborsteld
- Zamac onderconstructie
- Geschikt voor meerpuntsluiting



- SC = Rosace spirale
- Béquille inox fixed avec ressort de retenue à double sens
- Inox poli/mat brossé
- Sous-construction en zamac
- Approprié pour serrures multipoints



- SC = Schraubrosette
- Edelstahl Drücker festdrehbar mit doppeltätigem Hochhaltefeder
- Edelstahl poliert/matt gebürstet
- Zink Druckguß Unterkonstruktion
- Geeignet für Mehrfachverriegelung



- SC = screw rose
- Stainless steel lever sprungloaded with double working spring
- Polished/satin stainless steel
- Zinc diecast understructure
- Suitable for multipoint locks



6/7 mm	S12.667
8 mm	S12.68

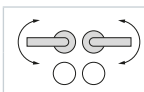

① ①	1002040-23
② ②	1002040-23

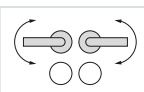

① ②	8 mm	1002040-68
-----	------	------------

Seville SC

3F

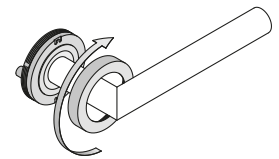
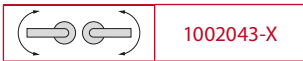
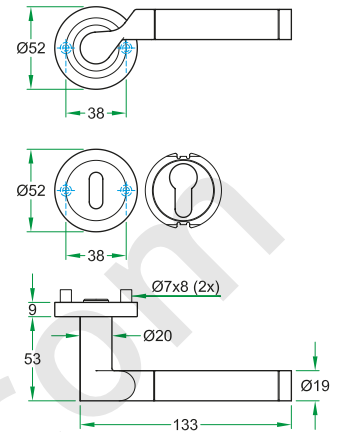

- SC = schroefrozet
- RVS deurkruk vastdraaibaar met dubbelwerkende veer op schroefrozet
- RVS gepolijst/mat geborsteld
- Zamac onderconstructie
- Geschikt voor meerpuntsluiting



- SC = Rosace spirale
- Béquille inox fixed avec ressort de retenue à double sens
- Inox poli/mat brossé
- Sous-construction en zamac
- Approprié pour serrures multipoints



- SC = Schraubrossette
- Edelstahl Drücker festdrehbar mit doppeltätigem Hochhaltefeder
- Edelstahl poliert/matt gebürstet
- Zink Druckguß Unterkonstruktion
- Geeignet für Mehrfachverriegelung



- SC = screw rose
- Stainless steel lever sprungloaded with double working spring
- Polished/satin stainless steel
- Zinc diecast understructure
- Suitable for multipoint locks



		1002043-23
		1002043-23

		8 mm	1002043-68

97011	97011

	6/7 mm	S12.667
	8 mm	S12.68

Space SC

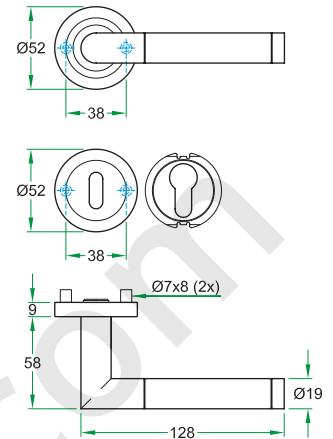

3F

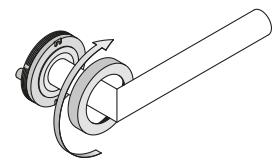
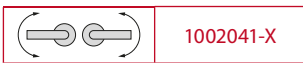

- SC = schroefrozet
- RVS deurkruk vastdraaibaar met dubbelwerkende veer op schroefrozet
- RVS gepolijst/mat geborsteld
- Zamac onderconstructie
- Geschikt voor meerpuntsluiting



- SC = Rosace spirale
- Béquille inox fixed avec ressort de retenue à double sens
- Inox poli/mat brossé
- Sous-construction en zamac
- Approprié pour serrures multipoints



- SC = Schraubrosette
- Edelstahl Drücker festdrehbar mit doppeltätigem Hochhaltefeder
- Edelstahl poliert/matt gebürstet
- Zink Druckguß Unterkonstruktion
- Geeignet für Mehrfachverriegelung



- SC = screw rose
- Stainless steel lever sprungloaded with double working spring
- Polished/satin stainless steel
- Zinc diecast understructure
- Suitable for multipoint locks



	6/7 mm	S12.667
	8 mm	S12.68

		1002041-23
		1002041-23

		8 mm	1002041-68

Tipo SC

3F

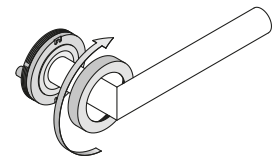
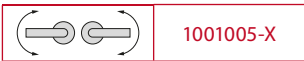
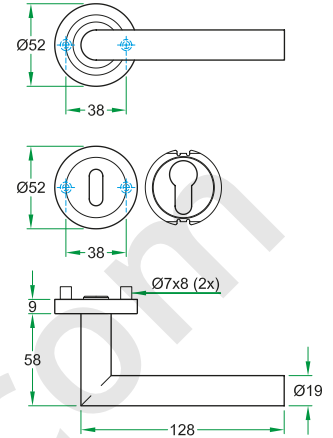

- SC = schroefrozet
- RVS deurkruk vastdraaibaar met dubbelwerkende veer op schroefrozet
- RVS mat geborsteld
- Zamac onderconstructie
- Geschikt voor meerpuntsluiting



- SC = Rosace spirale
- Béquille inox fixed avec ressort de retenue à double sens
- Inox at brossé
- Sous-construction en zamac
- Approprié pour serrures multipoints



- SC = Schraubrossette
- Edelstahl Drücker festdrehbar mit doppeltätigem Hochhaltefeder
- Edelstahl matt gebürstet
- Zink Druckguß Unterkonstruktion
- Geignet für Mehrfachverriegelung



- SC = screw rose
- Stainless steel lever sprungloaded with double working spring
- Satin stainless steel
- Zinc diecast understructure
- Suitable for multipoint locks

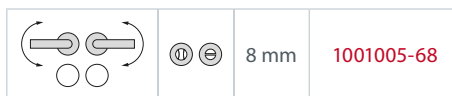
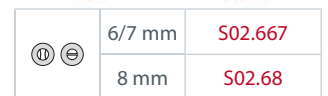
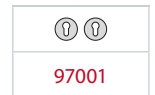

Uno SC

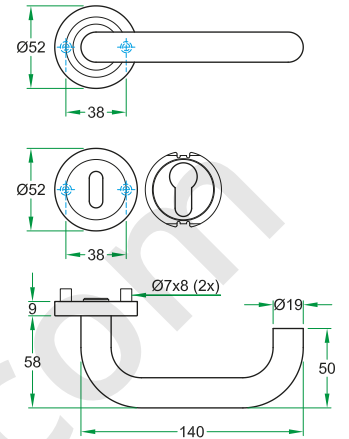

3F

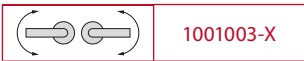

- SC = schroefrozet
- RVS deurkruk vastdraaibaar met dubbelwerkende veer op schroefrozet
- RVS mat geborsteld
- Zamac onderconstructie
- Geschikt voor meerpuntsluiting



- SC = Rosace spirale
- Béquille inox fixed avec ressort de retenue à double sens
- Inox at brossé
- Sous-construction en zamac
- Approprié pour serrures multipoints



- SC = Schraubrosette
- Edelstahl Drücker festdrehbar mit doppeltätigem Hochhaltefeder
- Edelstahl matt gebürstet
- Zink Druckguß Unterkonstruktion
- Geignet für Mehrfachverriegelung



- SC = screw rose
- Stainless steel lever sprungloaded with double working spring
- Satin stainless steel
- Zinc diecast understructure
- Suitable for multipoint locks



	⓪ ⓪	1001003-23
	⓪ ⓪	1001003-23

	⓪ ⊖	8 mm	1001003-68
	⓪ ⊖		

⓪ ⓪	⓪ ⓪
97001	97001

⓪ ⊖	⓪ ⊖
6/7 mm	S02.667
8 mm	S02.68

COMPONENTEN / COMPOSANTS / ZUBEHÖR / COMPONENTS

3F



91310



- Rvs mat geborsteld
- Wisselknop op schroef rozet
- Voor Gino SC, Tipo SC, Uno SC



- Inox mat brossé
- Bouton fixe sur rosace spirale
- Pour Gino SC, Tipo SC, Uno SC



- Edelstahl mat gebürstet
- Wechselknopf auf Schraufrosette
- Für Gino SC, Tipo SC, Uno SC



- Satin stainless steel
- Knob fixed on screw rose
- For Gino SC, Tipo SC, Uno SC

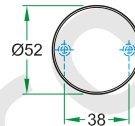
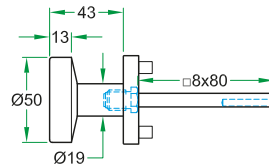

91311



- Rvs mat geborsteld/ gepolijst
- Wisselknop op schroef rozet
- voor Dorina SC, Lalita SC, Space SC, Seville SC



- Inox mat brossé/poli
- Bouton fixe sur rosace spirale
- pour Dorina SC, Lalita SC, Space SC, Seville SC



- Edelstahl mat gebürstet/poliert
- Wechselknopf auf Schraufrosette
- für Dorina SC, Lalita SC, Space SC, Seville SC



- Satin/polished stainless steel
- Knob fixed on screw rose
- For Dorina SC, Lalita SC, Space SC, Seville SC

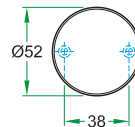
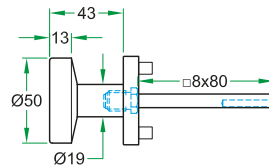

M4 x 65

Verlengde schroef / Vis allongée / Verlängerte Schraube / Extended screw

93206/2

 Langschilden

 Plaques longues

 Langschilder

 Long plates

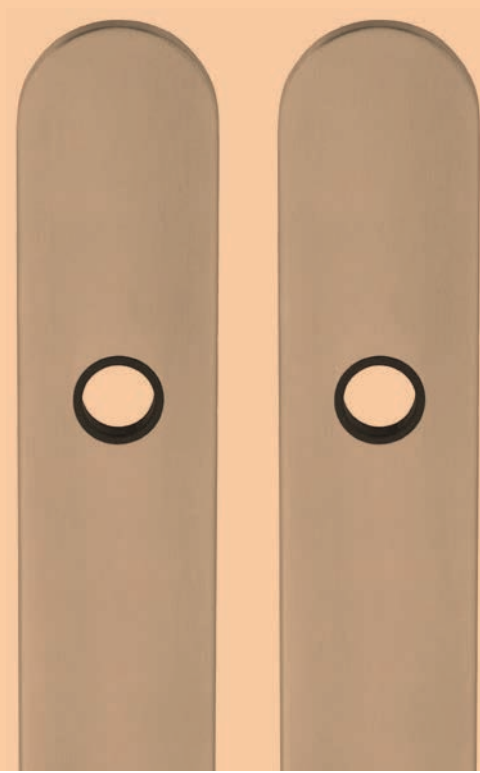

3G



04002/BL 257



04001/BL 258



04011/BL 259



04003/BL 257



04000/BL 258



04010/BL 259



04012/BL 260



92065/BL 261



04015/BL 260



92066/BL 261

Deurkrukken voor schilden / Béquilles pour plaques / Drücker für Schilder / Levers for plates 262

Langschilden / Plaques / Schilder / Plates

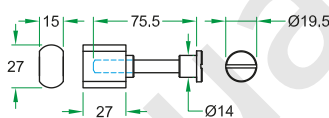
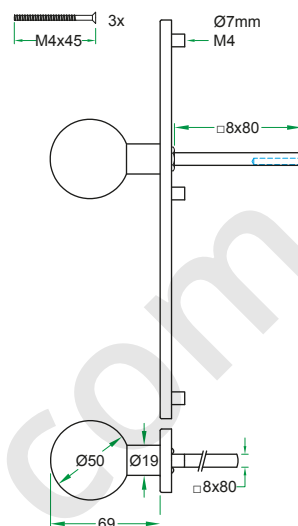
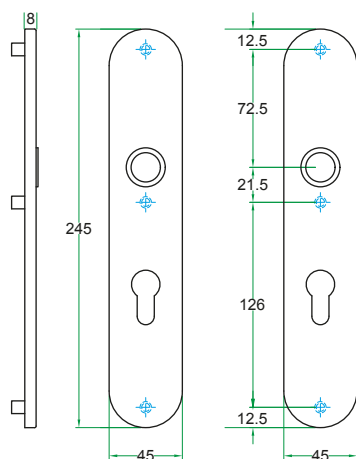

3G



- RVS mat geborsteld
- Blinde schroefbevestiging
- Paar langschilden zonder veer
- Deurkruk separaat bestellen
- WC-knop separaat bestellen
- Andere stansmaten mogelijk



- Inox mat brossé
- Fixation de vis invisible
- Paire plaques longue sans ressort
- Béquille à commander séparément
- Bouton de WC à commander séparément
- Possibilité d'adapter pour différents trous de serrure



- Edelstahl matt gebürstet
- Unsichtbare Schraubenbefestigung
- Paar Langschilder ohne Hochhaltefeder
- Drücker separat bestellen
- WC-Riegel separat bestellen
- Andere Entfernungen möglich



- Satin stainless steel
- Invisible screw fixing
- Pair long plates without spring
- Order lever separately
- Order WC-thumbturn separately
- Other key hole options possible

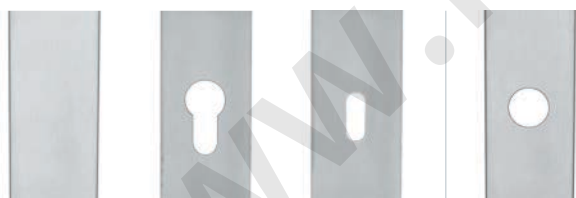

		04002/BL
	56 mm	04002/OB56
	72 mm	04002/OB72
	92 mm	04002/OB92
	110 mm	04002/OB110
	55 mm	04002/PC55
	72 mm	04002/PC72
	90 mm	04002/PC90
	92 mm	04002/PC92

	63 mm	04002/WC63
	72 mm	04002/WC72
	78 mm	04002/WC78
	90 mm	04002/WC90
	116 mm	04002/WC116
	6/7 mm	96011
	8 mm	96010

		-	04003/BL
		72 mm	04003/PC72
		-	04004/BL
		72 mm	04004/PC72

Krukmodellen - Modèles de béquilles - Drückermodele - Lever models ▶ 262-263

Langschilden / Plaques / Schilder / Plates

3G

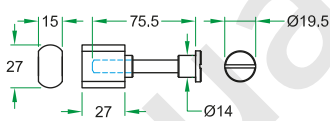
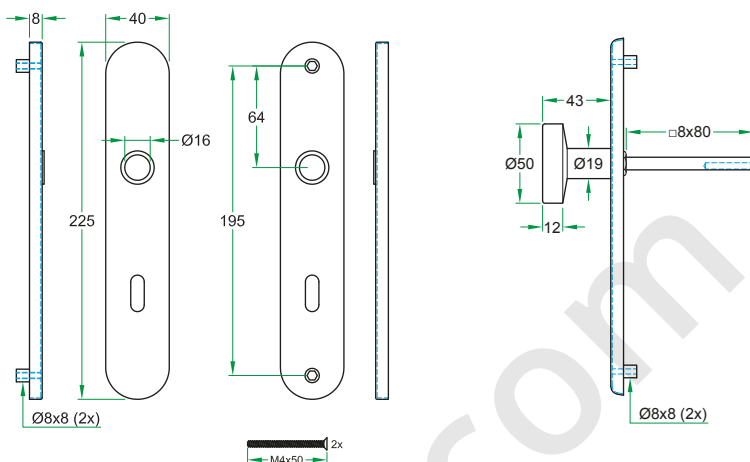

- RVS mat geborsteld
- Eenzijdig met schroefnocken M4
- Paar langschilden zonder veer
- Deurkruk separaat bestellen
- WC-knop separaat bestellen
- Andere stansmaten mogelijk



- Inox mat brossé
- Unilatéral avec cames M4
- Paire plaques longue sans ressort
- Béquille à commander séparément
- Bouton de WC à commander séparément
- Possibilité d'adapter pour différents trous de serrure



- Edelstahl matt gebürstet
- Einseitig mit Schraubnocken M4
- Paar Langschilder ohne Hochhaltefeder
- Drücker separat bestellen
- WC-Riegel separat bestellen
- Andere Entfernungen möglich



- Satin stainless steel
- One-sided with lugs M4
- Pair long plates without spring
- Order lever separately
- Order WC-thumbturn separately
- Other key hole options possible

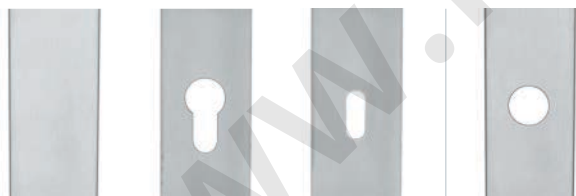

		04001/BL	
	56 mm	04001/OB56	
		72 mm	04001/OB72
	90 mm	04001/OB90	
	55 mm	04001/PC55	
		72 mm	04001/PC72
	90 mm	04001/PC90	

	63 mm	04001/WC63
	72 mm	04001/WC72
	78 mm	04001/WC78
	6/7 mm	96011
	8 mm	96010

		-	04000/BL
		72 mm	04000/PC72

Krukmodellen - Modèles de béquilles - Drückermodelle - Lever models ▶ 262-263

Langschilden / Plaques / Schilder / Plates

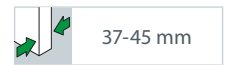
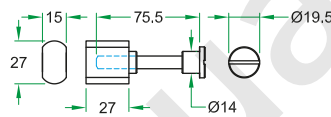
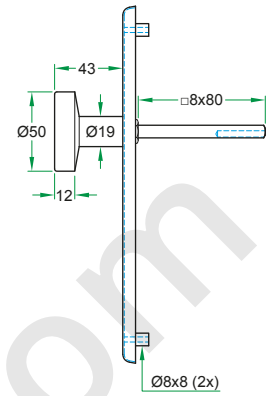
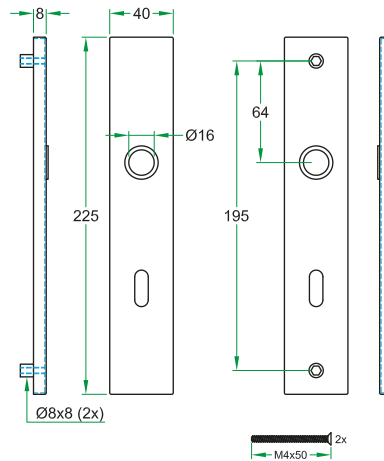
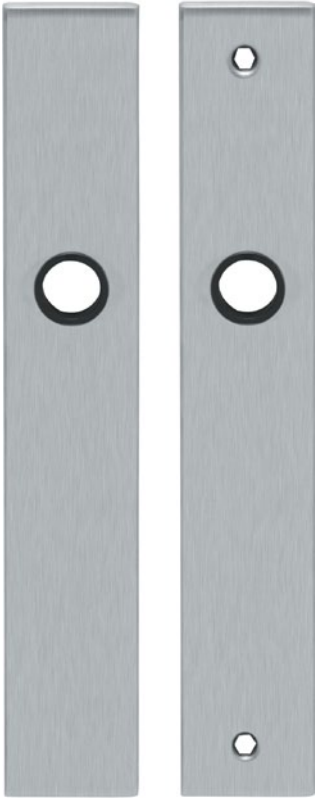

3G



- RVS mat geborsteld
- Eenzijdig met schroefnocken M4
- Paar langschilden zonder veer
- Deurkruk separaat bestellen
- WC-knop separaat bestellen
- Andere stansmaten mogelijk



- Inox mat brossé
- Unilatéral avec cames M4
- Paire plaques longue sans ressort
- Béquille à commander séparément
- Bouton de WC à commander séparément
- Possibilité d'adapter pour différents trous de serrure



- Edelstahl matt gebürstet
- Einseitig mit Schraubnocken M4
- Paar Langschilder ohne Hochhaltefeder
- Drücker separat bestellen
- WC-Riegel separat bestellen
- Andere Entfernungen möglich



- Satin stainless steel
- One-sided with lugs M4
- Pair long plates without spring
- Order lever separately
- Order WC-thumbturn separately
- Other key hole options possible

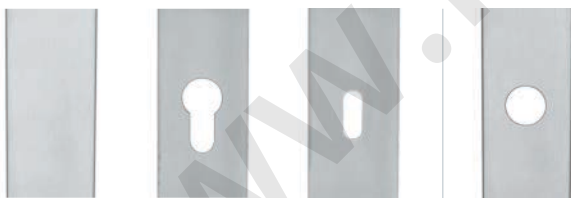

		04011/BL	
	56 mm	04011/OB56	
		72 mm	04011/OB72
	90 mm	04011/OB90	
	55 mm	04011/PC55	
		72 mm	04011/PC72
	90 mm	04011/PC90	

	63 mm	04011/WC63
	72 mm	04011/WC72
	78 mm	04011/WC78
	6/7 mm	96011
	8 mm	96010

		-	04010/BL
		72 mm	04010/PC72

Langschilden / Plaques / Schilder / Plates

3G

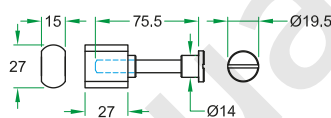
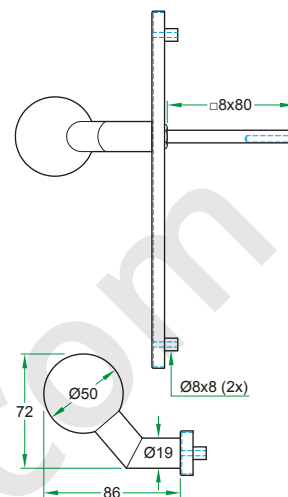
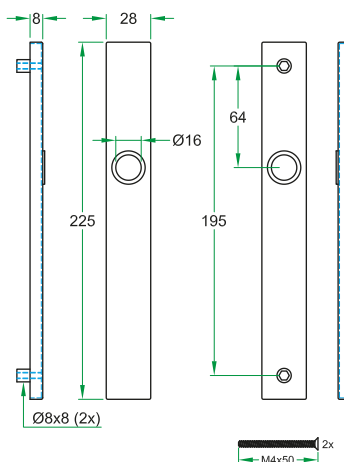
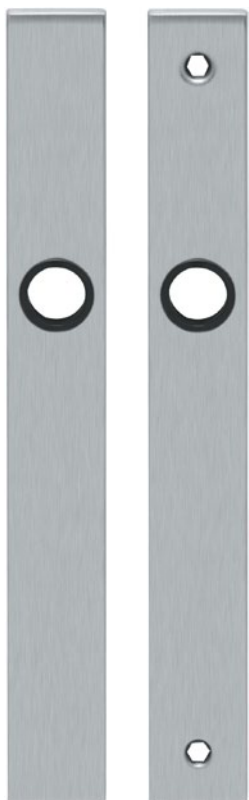

- RVS mat geborsteld
- Eenzijdig met schroefnokken M4
- Paar langschilden zonder veer
- Deurkruk separaat bestellen
- WC-knop separaat bestellen
- Andere stansmaten mogelijk



- Inox mat brossé
- Unilatéral avec cames M4
- Paire plaques longue sans ressort
- Béquille à commander séparément
- Bouton de WC à commander séparément
- Possibilité d'adapter pour différents trous de serrure



- Edelstahl matt gebürstet
- Einseitig mit Schraubnocken M4
- Paar Langschilder ohne Hochhaltefeder
- Drücker separat bestellen
- WC-Riegel separat bestellen
- Andere Entfernungen möglich



- Satin stainless steel
- One-sided with lugs M4
- Pair long plates without spring
- Order lever separately
- Order WC-thumbturn separately
- Other key hole options possible



		04012/BL	
	72 mm	04012/OB72	
		90 mm	04012/OB90
	55 mm	04012/PC55	
	72 mm	04012/PC72	
		90 mm	04012/PC90
	92 mm	04012/PC92	

	63 mm	04012/WC63
	72 mm	04012/WC72
	90 mm	04012/WC90
	6/7 mm	96011
	8 mm	96010

		-	04015/BL
		72 mm	04015/PC72

Krukmodellen - Modèles de béquilles - Drückermodele - Lever models ▶ 262-263

Langschilden / Plaques / Schilder / Plates

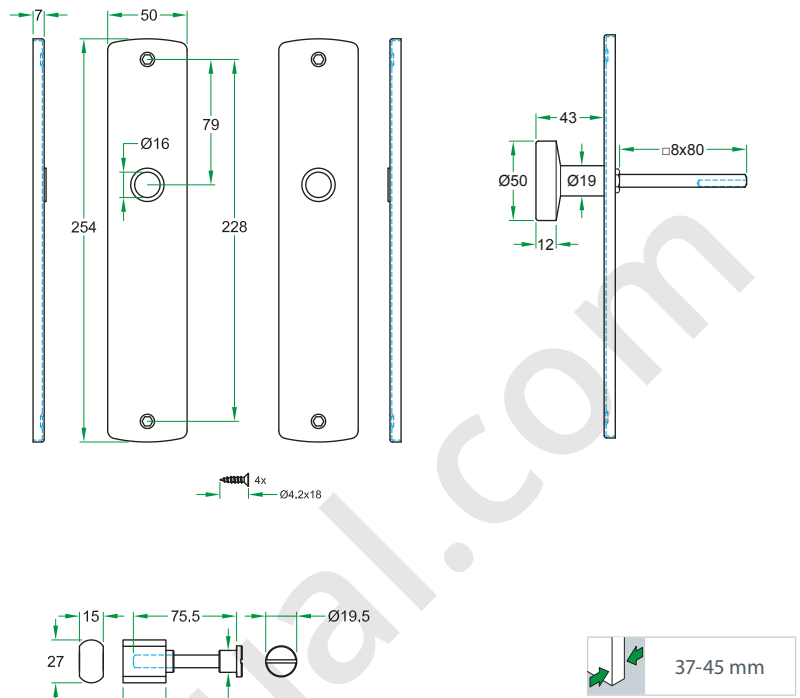
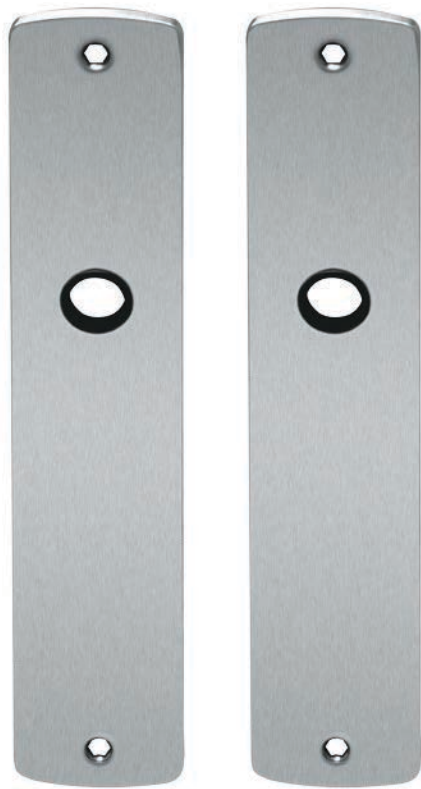

3G



- RVS mat geborsteld
- Zichtbare schroefbevestiging
- Paar renovatie langschilden zonder veer
- Deurkruk separaat bestellen
- WC-knop separaat bestellen
- Andere stansmaten mogelijk



- Inox mat brossé
- Fixation de vis visible
- Paire plaques longue de rénovation sans ressort
- Béquille à commander séparément
- Bouton de WC à commander séparément
- Possibilité d'adapter pour différents trous de serrure



- Edelstahl matt gebürstet
- Sichtbare Schraubenbefestigung
- Paar Renovierungslangschilder ohne Hochhaltefeder
- Drücker separat bestellen
- WC-Riegel separat bestellen
- Andere Entfernungen möglich



- Satin stainless steel
- Visible screw fixing
- Pair renovation long plates without spring
- Order lever separately
- Order WC-thumbturn separately
- Other key hole options possible

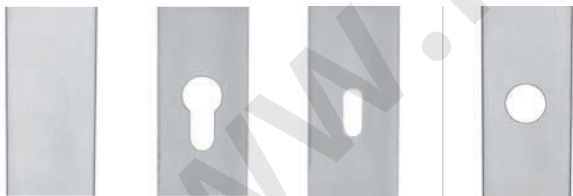

○		92065/BL
	56 mm	92065/OB56
	72 mm	92065/OB72
	90 mm	92065/OB90
⓪	110 mm	92065/OB110
	55 mm	92065/PC55
	72 mm	92065/PC72
Ⓧ	90 mm	92065/PC90
	92 mm	92065/PC92

○ ○	63 mm	92065/WC63
	72 mm	92065/WC72
	78 mm	92065/WC78
	90 mm	92065/WC90
Ⓧ	116 mm	92065/WC116
	6/7 mm	96011
	8 mm	96010

○ ○	-	92066/BL
	Ⓧ Ⓧ	72 mm

Krukmodellen - Modèles de béquilles - Drückermodele - Lever models ▶ 262-263

Langschilden / Plaques / Schilder / Plates

Deurkrukken voor schilden • Béquilles pour plaques • Drücker für Schilder • Levers for plates

3G

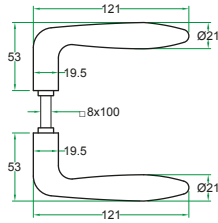

Cino **00190-WCX**

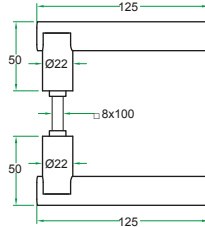

Dorina **00520**

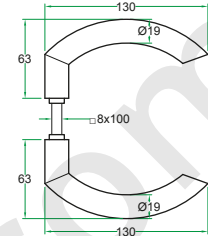

Gino **00180-WCX**

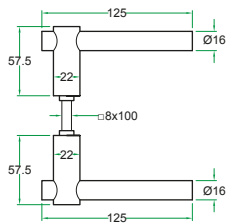

Gisela **00820**

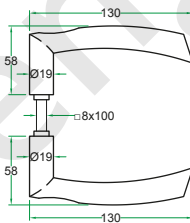

Ilsa **00840-WCX**

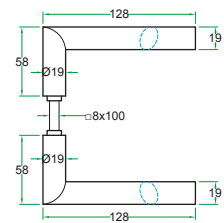

Jade **00800-WCX**

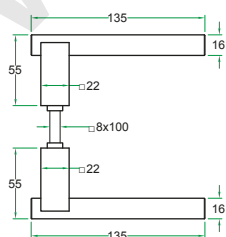

Karina **00500**

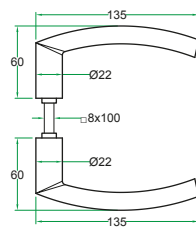

Lana **00970**

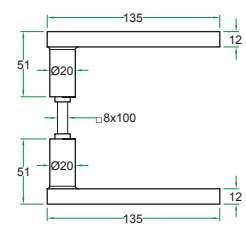

Laura **00900**

Langschilden / Plaques / Schilder / Plates

Deurkrukken voor schilden • Béquilles pour plaques • Drücker für Schilder • Levers for plates

3G

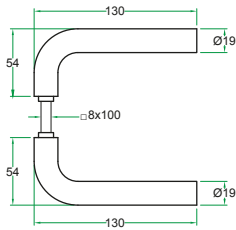

Lido **00100-WCX**

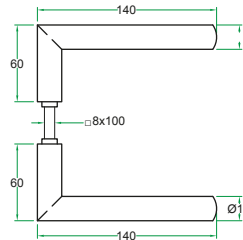

Pipo **00140-WCX**

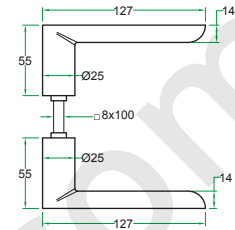

Polo **00940**

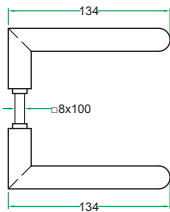

Primo **00890-WCX**

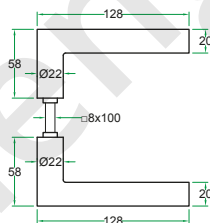

Saba **00910**

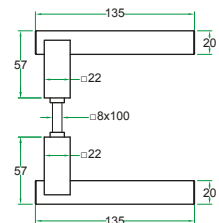

Sabrina **00510**

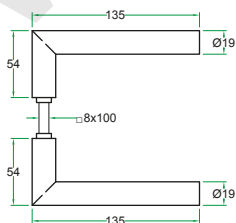
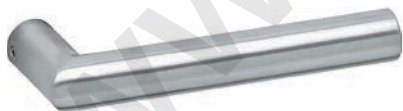

Tipo **00120-WCX**

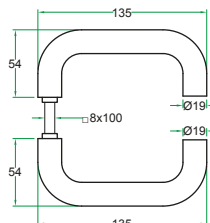

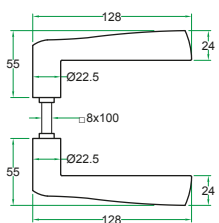

Uno **00110-WCX**



Wing **00850-WCX**



Project: Nieuw-Argentinië
Architect: Breilman & Breilman, Paris

  Ton - Jaren 30 Stijl

  Ton - Le style des années 30

 Ton - 30. Jahre Stil

 Ton - 30th Style



Ton

Jaren 30 Stijl / Le style des années 30 / 30. Jahre Stil / 30th Style

3H

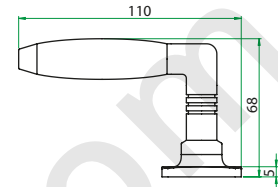
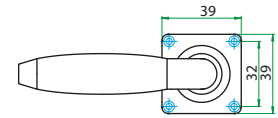

- Massief messing/ebbenhout
- Nikkel mat geborsteld



- Laiton massif/bois d'ébène
- Nickel mat brossé



- Massiv Messing/Ebenholz
- Nickel matt gebürstet



- Solid brass/ebony wood
- Satin nickel

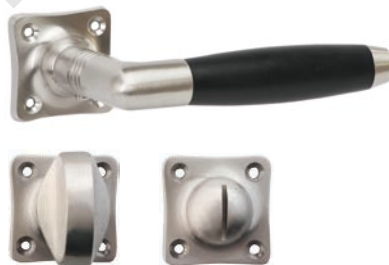

		97111
		97112

		8 mm	97113
--	--	------	-------

Ton

Jaren 30 Stijl / Le style des années 30 / 30. Jahre Stil / 30th Style

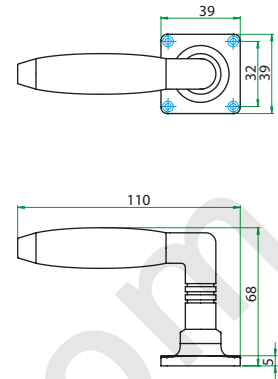

3H



- Massief messing/ebbenhout
- Glans nikkel



- Laiton massif/bois d'ébène
- Nickel poli



- Massiv Messing/Ebenholz
- Nickel poliert



- Solid brass/ebony wood
- Polished nickel

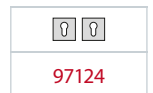

		97101
		97102

		8 mm	97103
--	--	------	-------

	8 mm	97125
--	------	-------

Ton

Jaren 30 Stijl / Le style des années 30 / 30. Jahre Stil / 30th Style

3H

• Massief messing
toiletsluiting

• Fermeoir pour WC en
laiton massif

• Massiv Messing WC
Schließung

• Solid brass WC
fastener



Mat nikkel / Nickel mat brossé Nickel matt gebürstet / Satin nickel	Glans nikkel / Nickel poli Nickel poliert / Polished nickel
97116	97106



Mat nikkel / Nickel mat brossé Nickel matt gebürstet / Satin nickel	Glans nikkel / Nickel poli Nickel poliert / Polished nickel
97117	97107

• Massief messing/
ebbenhout
meubelgreep

• Tirant de meuble
laiton massif/bois
d'ébène

• Massiv Messing/
Ebenholz Möbelgriff

• Solid brass/ebony
wood furniture pull



Mat nikkel / Nickel mat brossé Nickel matt gebürstet / Satin nickel	Glans nikkel / Nickel poli Nickel poliert / Polished nickel
97135	97134

Ton

Jaren 30 Stijl / Le style des années 30 / 30. Jahre Stil / 30th Style



- Massief messing/ebbenhout schuifdeurgreep

- Tirant pour porte coulissante en laiton massif/bois d'ébène

- Massiv Messing/Ebenholz Schiebetürgriff

- Solid brass/Ebony wood sliding pull

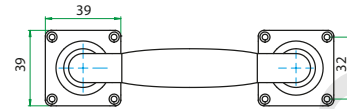
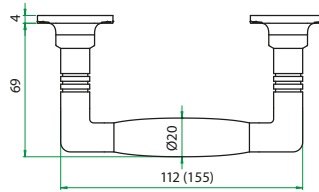

Lengte / Longueur Länge / Length	Mat nikkel / Nickel mat Nickel matt gebürstet / Satin nickel	Glans nikkel / Nickel poli Nickel poliert / Polished nickel
112 mm	97114	97104
155 mm	97127	97126



- Massief messing schuifdeursluiting
- 110 mm x 53 mm

- Fermeur pour porte coulissante en laiton massif
- 110 mm x 53 mm

- Massiv Messing Schiebetür Schließung
- 110 mm x 53 mm

- Solid brass closer for sliding door
- 110 mm x 53 mm

Mat nikkel / Nickel mat Nickel matt gebürstet / Satin nickel	Glans nikkel / Nickel poli Nickel poliert / Polished nickel
97128	97129



- Massief messing schuifdeurkom

- Cuvette pour porte coulissante en laiton massif

- Massiv Messing Schiebetürmuschel

- Solid brass sliding pull

Mat nikkel / Nickel mat Nickel matt gebürstet / Satin nickel	Glans nikkel / Nickel poli Nickel poliert / Polished nickel
97131	97130

Ton

Raam jaren 30 Stijl / Fenêtre style des années 30 / Fenster 30. Jahre stil / Window 30th style

• Massief messing/
ebbenhout
raambeslag

• Quincaillerie pour
la fenêtre en laiton
massif/bois d'ébène

• Massiv Messing/
Ebenholz
Fensterbeschläge

• Solid brass/ebony
wood window
furniture

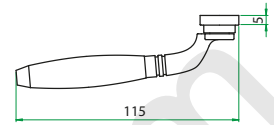
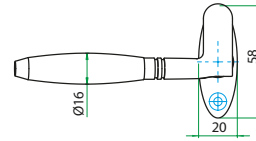

	Mat nikkel / Nickel mat Nickel matt gebürstet / Satin nickel	Glans nikkel / Nickel poli Nickel poliert / Polished nickel
Links / Gauche / Links / Left	97119L	97109L
Rechts / Droit / Recht / Right	97119R	97109R



	Mat nikkel / Nickel mat Nickel matt gebürstet / Satin nickel	Glans nikkel / Nickel poli Nickel poliert / Polished nickel
	97133	97132



	Mat nikkel / Nickel mat Nickel matt gebürstet / Satin nickel	Glans nikkel / Nickel poli Nickel poliert / Polished nickel
	97115	97105

Ton

Jaren 30 Stijl / Le style des années 30 / 30. Jahre Stil / 30th Style

- Espagnolet
- Massief messing/
ebbenhout
- Compleet incl. stang
voor deurhoogte
255 cm

- Espagnolette
- Laiton massif/bois
d'ébené
- Complète incl.
barre pour hauteur
de la porte 255 cm

- Espagnolet
- Massiv Messing/
Ebenholz
- Komplett einsch.
Schliesstange
für Türhöhe 255 cm

- Espagnolet
- Solid brass/ebony
wood
- Complete incl. bar for
doorheight 255 cm



Mat nikkel / Nickel mat Nickel matt gebürstet / Satin nickel	Glans nikkel / Nickel poli Nickel poliert / Polished nickel
97118	97108

3H



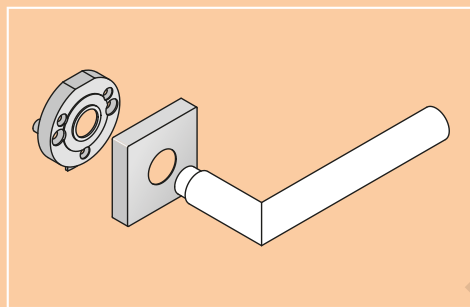
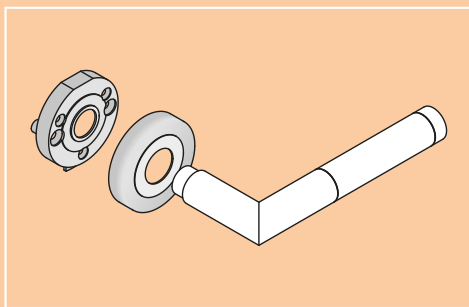

Interior Accents

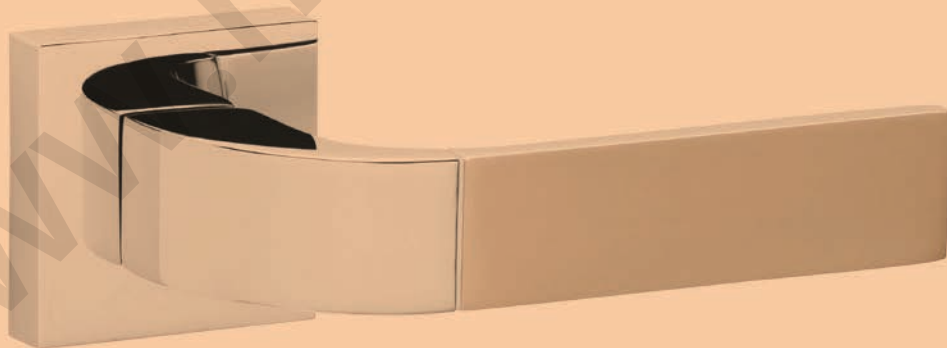

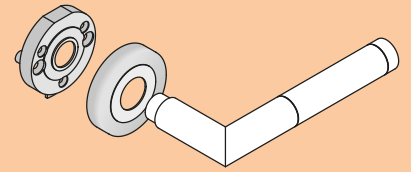

31



Anika 276



Seville 285



Futura 278



Ibiza 280



Space 287



Lagos 281



Viva 288

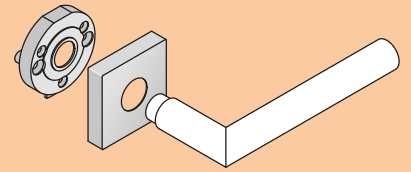

Futura 279



Lubi 283



Sienna 286



Dion 277



Napa 284



Lubi 282

Anika

Interior Accents

31

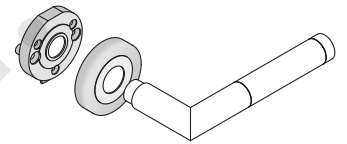
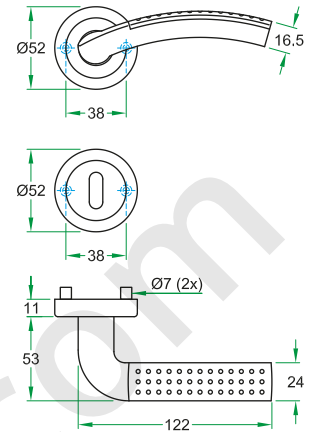

- Chrom glans/-nikkel mat geborsteld
- Kunststof onderconstructie met geïntegreerde veer



- Chromé poli/nickel mat brossé
- Sous-construction nylon avec ressort de retenue



- Chrom poliert/-Nickel matt gebürstet
- Kunststoff Unterkonstruktion mit integrierter Hochhaltefeder



- Polished chrome/satin nickel
- Nylon understructure with integrated spring



			03251
			03252

			8 mm	03253
--	--	--	------	-------



		6/7 mm	03555
		8 mm	03554S

Dion

Interior Accents

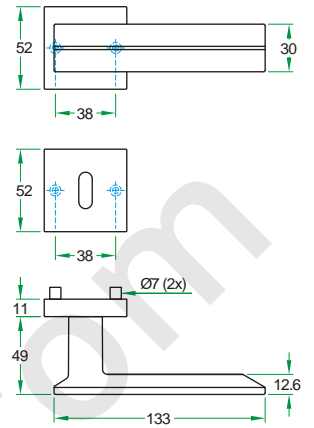

31

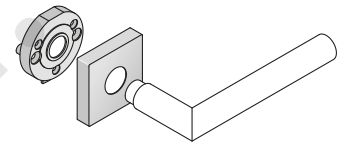

- Chrom glans/-nikkel mat geborsteld
- Kunststof onderconstructie met geïntegreerde veer



- Chromé poli/nickel mat brossé
- Sous-construction nylon avec ressort de retenue



- Chrom poliert/-Nickel matt gebürstet
- Kunststoff Unterkonstruktion mit integrierter Hochhaltefeder



- Polished chrome/satin nickel
- Nylon understructure with integrated spring

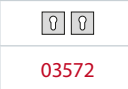
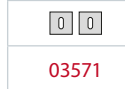

		03461
		03462

		8 mm	03463
--	--	------	-------



	6/7 mm	03575
	8 mm	03574



	6/7 mm	03575
	8 mm	03574

Futura

Interior Accents

31

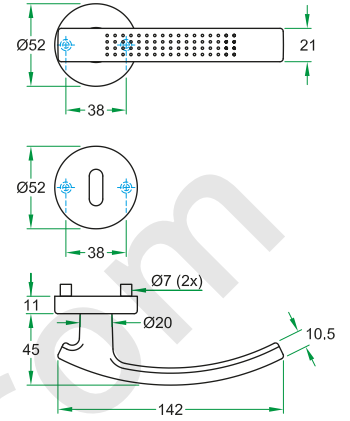

- Nikkel mat geborsteld
- Kunststof onderconstructie met geïntegreerde veer

- Nickel mat brossé
- Sous-construction nylon avec ressort de retenue

- Nickel matt gebürstet
- Kunststoff Unterkonstruktion mit integrierter Hochhaltefeder

- Brushed nickel
- Nylon understructure with integrated spring



		00451
		00452

		8 mm	00453
--	--	------	-------

2R11.WCX	2R12.WCX

	6/7 mm	2R10.T67.WCX
	8 mm	2R10.T8.WCX

Futura

Interior Accents

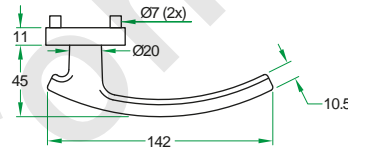
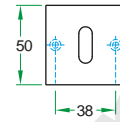
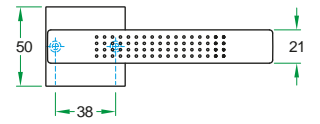
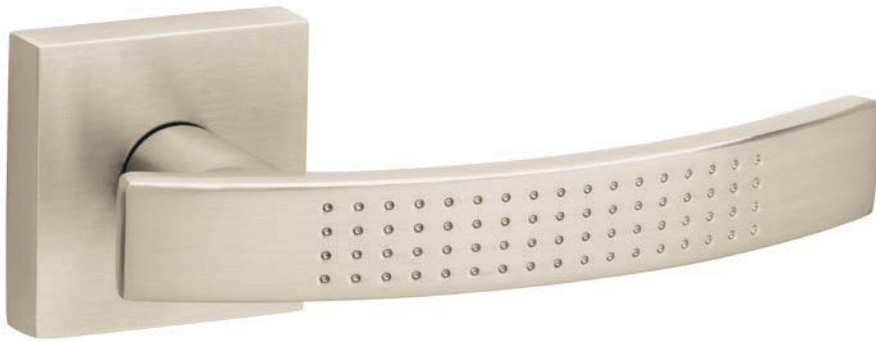

31

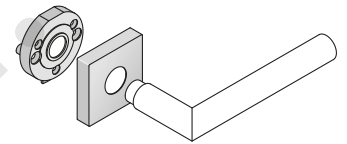

- Nikkel mat geborsteld
- Kunststof onderconstructie met geïntegreerde veer



- Nickel mat brossé
- Sous-structure nylon avec ressort de retenue



- Nickel matt gebürstet
- Kunststoff Unterkonstruktion mit integrierter Hochhaltefeder



- Brushed nickel
- Nylon understructure with integrated spring

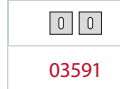

03591

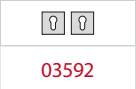

03592



6/7 mm

03596

8 mm

03594



Ibiza

Interior Accents

31

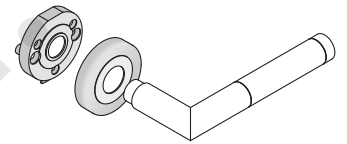
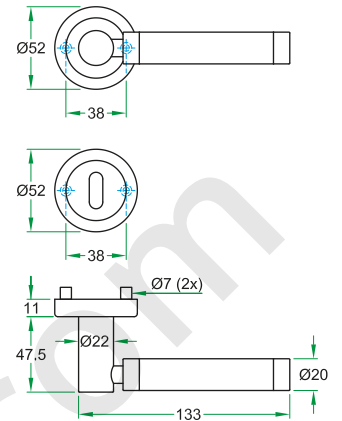

- Chrom glans/rvs mat geborsteld
- Kunststof onderconstructie met geïntegreerde veer



- Chromé poli/inox mat brosse
- Sous-construction nylon avec ressort de retenue



- Chrom poliert/-Edelstahl matt gebürstet
- Kunststoff Unterkonstruktion mit integrierter Hochhaltefeder



- Polished chrome/-satin stainless steel
- Nylon understructure with integrated spring

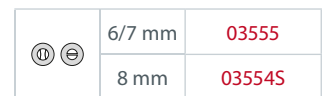
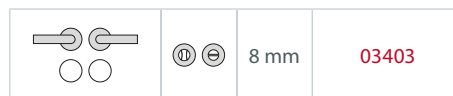
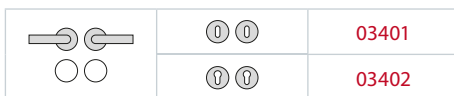
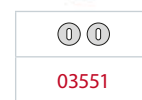

Lagos

Interior Accents

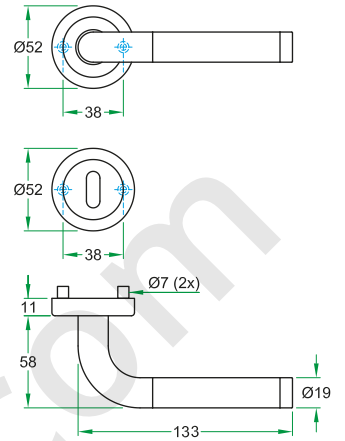

31



- RVS gepolijst/mat geborsteld
- Kunststof onderconstructie met geïntegreerde veer



- Inox poli/mat brossé
- Sous-construction nylon avec ressort de retenue



- Edelstahl poliert/matt gebürstet
- Kunststoff Unterkonstruktion mit integrierter Hochhaltefeder



- Polished/satin stainless steel
- Nylon understructure with integrated spring

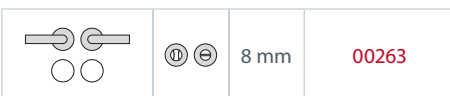
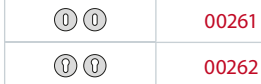
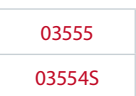
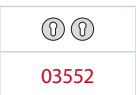
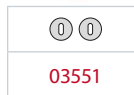

Lubi

Interior Accents

31

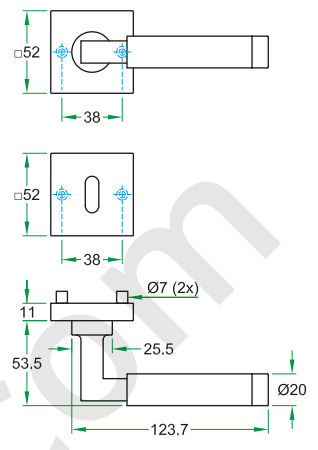

- Chrom glans/-nikkel mat geborsteld
- Kunststof onderconstructie met geïntegreerde veer



- Chromé poli/nickel mat brossé
- Sous-construction nylon avec ressort de retenue



- Chrom poliert/-Nickel matt gebürstet
- Kunststoff Unterkonstruktion mit integrierter Hochhaltefeder



- Polished chrome/satin nickel
- Nylon understructure with integrated spring



		03201
		03202



		8 mm	03203
--	--	------	-------



	6/7 mm	03575
	8 mm	03574

Lubi

Interior Accents

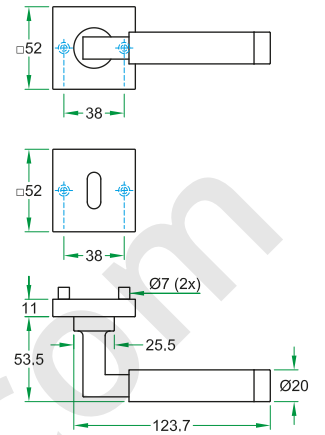

31



- Chrom glans/zwart
- Kunststof onderconstructie met geïntegreerde veer



- Chromé poli/noir
- Sous-construction nylon avec ressort de retenue



- Chrom poliert/schwarz
- Kunststoff Unterkonstruktion mit integrierter Hochhaltefeder



- Polished chrome/black
- Nylon understructure with integrated spring

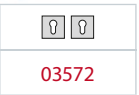
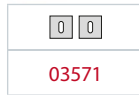

		03211
		03212

		8 mm	03213
--	--	------	-------



	6/7 mm	03575
	8 mm	03574

Napa

Interior Accents

31

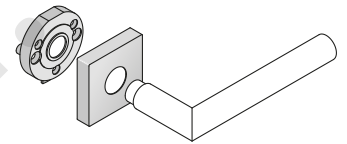
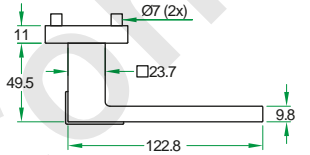
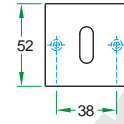
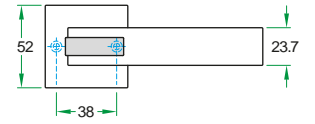

- Chrom glans/-nikkel mat geborsteld
- Kunststof onderconstructie met geïntegreerde veer



- Chromé poli/nickel mat brossé
- Sous-construction nylon avec ressort de retenue



- Chrom poliert/-Nickel matt gebürstet
- Kunststoff Unterkonstruktion mit integrierter Hochhaltefeder



- Polished chrome/satin nickel
- Nylon understructure with integrated spring



		03411/C
		03412/C



		8 mm	03413/C

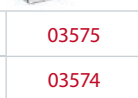
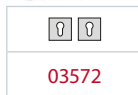
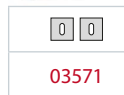

Seville

Interior Accents

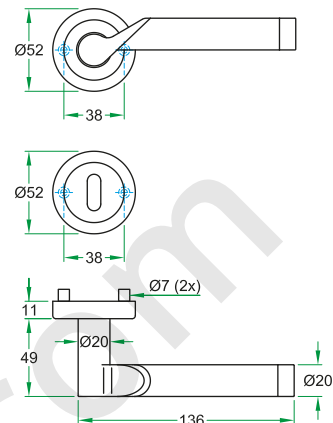

31



- Chrom glans/rvs mat geborsteld
- Kunststof onderconstructie met geïntegreerde veer



- Chromé poli/inox mat brossé
- Sous-construction nylon avec ressort de retenue



- Chrom poliert/-Edelstahl matt gebürstet
- Kunststoff Unterkonstruktion mit integrierter Hochhaltefeder



- Polished chrome/-satin stainless steel
- Nylon understructure with integrated spring

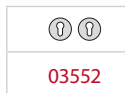
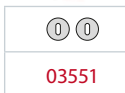

		03441
		03442

		8 mm	03443



	6/7 mm	03555
	8 mm	03554S

Sienna

Interior Accents

31

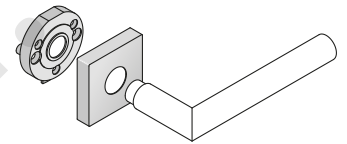
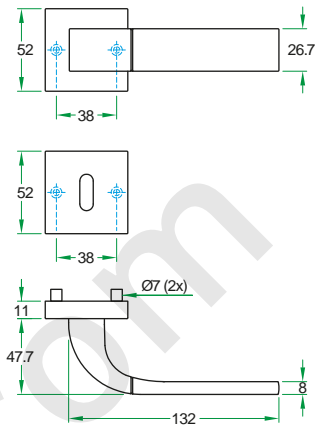

- Chrom glans/-nikkel mat geborsteld
- Kunststof onderconstructie met geïntegreerde veer



- Chromé poli/nickel mat brossé
- Sous-construction nylon avec ressort de retenue



- Chrom poliert/-Nickel matt gebürstet
- Kunststoff Unterkonstruktion mit integrierter Hochhaltefeder



- Polished chrome/satin nickel
- Nylon understructure with integrated spring



		03481
		03482



		8 mm	03483



	03571
--	-------



	03572
--	-------



	6/7 mm	03575
	8 mm	03574



	8 mm	03574
--	------	-------

Space

Interior Accents

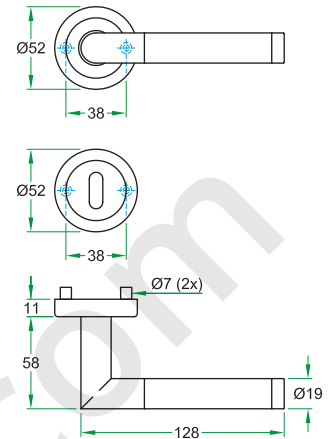

31



- RVS gepolijst/mat geborsteld
- Kunststof onderconstructie met geïntegreerde veer



- Inox poli/mat brossé
- Sous-structure nylon avec ressort de retenue



- Edelstahl poliert/matt gebürstet
- Kunststoff Unterkonstruktion mit integrierter Hochhaltefeder



- Polished/satin stainless steel
- Nylon understructure with integrated spring



		00271
		00272

		8 mm	00273
--	--	------	-------



	6/7 mm	03555
	8 mm	03554S

Viva

Interior Accents

31

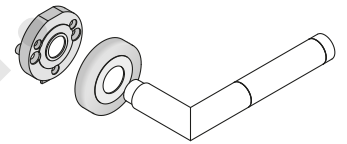
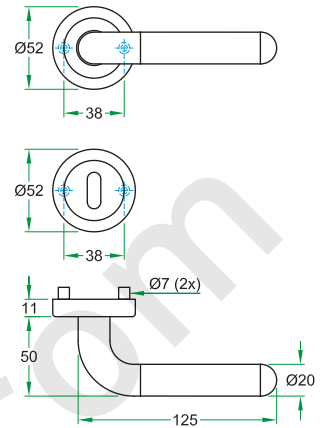

- Chrom glans/rvs mat geborsteld
- Kunststof onderconstructie met geïntegreerde veer



- Chromé poli/inox mat brossé
- Sous-construction nylon avec ressort de retenue



- Chrom poliert/-Edelstahl matt gebürstet
- Kunststoff Unterkonstruktion mit integrierter Hochhaltefeder



- Polished chrome/-satin stainless steel
- Nylon understructure with integrated spring

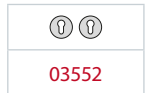
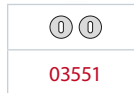

6/7 mm

03555

8 mm

03554S



⓪ ⓪

03231

⓪ ⓪

03232



⓪ ⓪

8 mm

03233

'Black is Beautiful'



Lana

3J

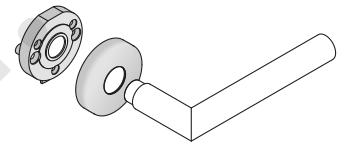
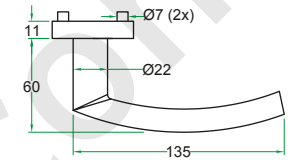
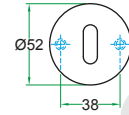
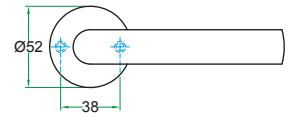

- Mat zwart (structuur) poedercoating
- Kunststof onderconstructie met geïntegreerde veer



- Revêtement en poudre (structure) noir mat
- Sous-construction nylon avec ressort de retenue



- Schwarz matt Struktur-Pulverbeschichtung
- Kunststoff Unterkonstruktion mit integrierter Hochhaltefeder



- Satin black (structure) powdercoating
- Nylon understructure with integrated spring



① ①
2R11.WCX/BL



① ①
2R12.WCX/BL



① ②
8 mm 2R10.T8.WCX/BL

Tipo

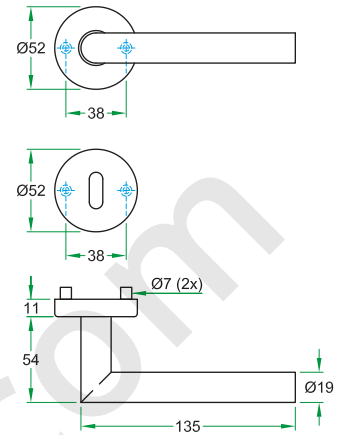

3J



- Mat zwart (structuur) poedercoating
- Kunststof onderconstructie met geïntegreerde veer



- Revêtement en poudre (structure) noir mat
- Sous-construction nylon avec ressort de retenue



- Schwarz matt Struktur-Pulverbeschichtung
- Kunststoff Unterkonstruktion mit integrierter Hochhaltefeder



- Satin black (structure) powdercoating
- Nylon understructure with integrated spring



2R11.WCX/BL



2R12.WCX/BL



8 mm 2R10.T8.WCX/BL

Black is Beautiful

3J

NIEUW • NOUVEAU • NEU • NEW



Wij kunnen onze standaard rvs producten poedercoaten voor uw binnen- en buitendeur.

Bel ons voor prijzen en levertijd.



Nous pouvons revêtement en poudre nos produits standard en inox pour votre porte intérieure ou extérieure.

Communiquez avec nous pour prix e délai de livraison.



Wir können unsere standard Edelstahl Produkten Pulverbeschichten für Ihre Innen- oder Außentür.

Rufen Sie uns an für Preise und Liefertermin.



We can powdercoat our standard stainless steel products for your interior- or exterior door.

Call us for prices and delivery time.

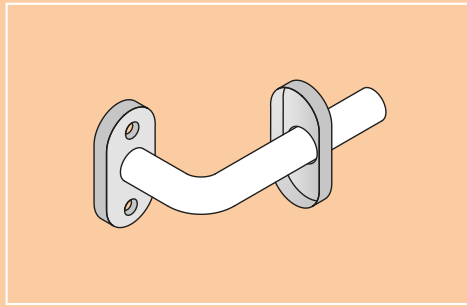

  Profieldeur

  Porte à chassis profile

 Schmallrahmen

 Profile door



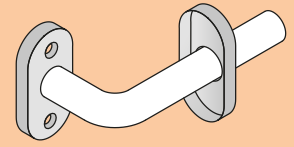

3K



Clara PD 30



Lido PD 30



Tipo PD 30

www.mengual.com

Clara

Profieldeurbeslag / Quincaillerie de porte pour châssis profilé / Schmalrahmen / Narrow profile door hardware

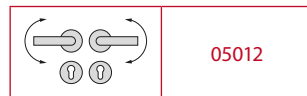
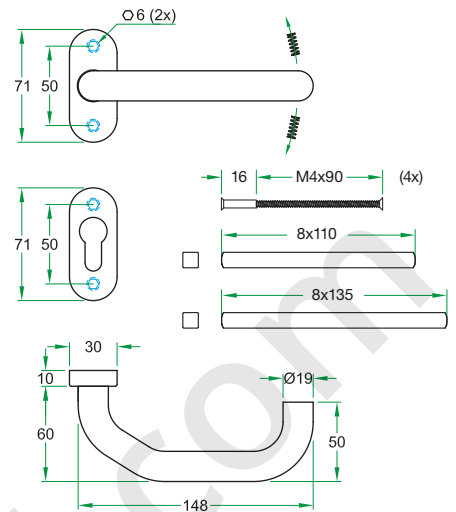

- RVS onderconstructie zonder nokken
- Kruk vastdraaibaar op rozet
- RVS mat geborsteld
- Incl. 2 vierkantstiften t.b.v. DD 37-77 mm
- Geschikt voor sloten met meerpuntsluiting



- Sous-construction inox sans pilier
- Béquille fixe avec ressort de retenue
- Inox mat brossé
- 2 Tiges carrée incl. pour EP 37-77 mm
- Approprié pour serrures multipoint



- Edelstahl Unterkonstruktion ohne Nocken
- Drücker festmontiert mit Hochhaltefeder
- Edelstahl matt gebürstet
- Einschl. 2 Vierkantstifte für TS 37-77 mm
- Geeignet für Mehrfachschlösser



- Stainless steel understructure without lugs
- Lever sprungloaded
- Satin stainless steel
- Incl. 2 spindles for doorthickness 37-77 mm
- Suitable for multipoint lock

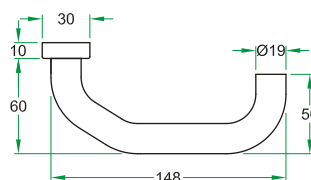
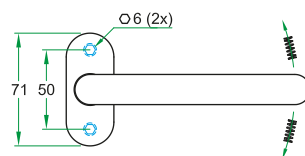

Lido

Profieldeurbeslag / Quincaillerie de porte pour châssis profilé / Schmalrahmen / Narrow profile door hardware

3K

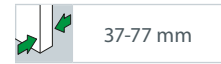
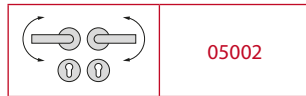
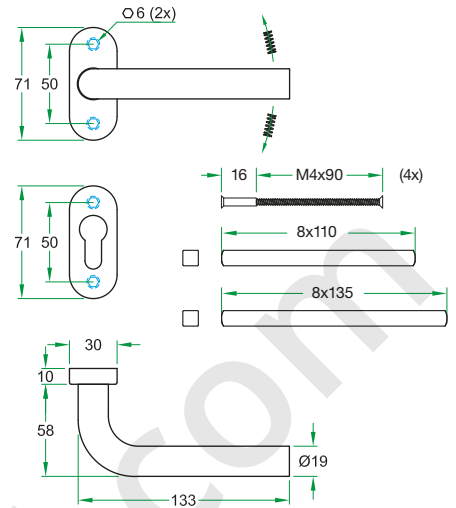

- RVS onderconstructie zonder nokken
- Kruk vastdraaibaar op rozet
- RVS mat geborsteld
- Incl. 2 vierkantstiften t.b.v. DD 37-77 mm
- Geschikt voor sloten met meerpuntsluiting



- Sous-construction inox sans pilier
- Béquille fixe avec ressort de retenue
- Inox mat brossé
- 2 Tiges carrée incl. pour EP 37-77 mm
- Approprié pour serrures multipoint



- Edelstahl Unterkonstruktion ohne Nocken
- Drücker festmontiert mit Hochhaltefeder
- Edelstahl matt gebürstet
- Einsch. 2 Vierkantstifte für TS 37-77 mm
- Geeignet für Mehrfachschlösser



- Stainless steel understructure without lugs
- Lever sprungloaded
- Satin stainless steel
- Incl. 2 spindles for doorthickness 37-77 mm
- Suitable for multipoint lock

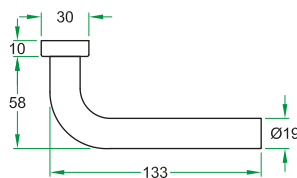
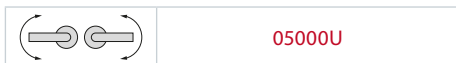
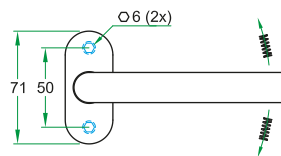

Tipo

Profieldeurbeslag / Quincaillerie de porte pour châssis profilé / Schmalrahmen / Narrow profile door hardware

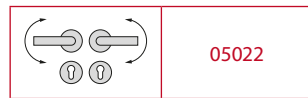
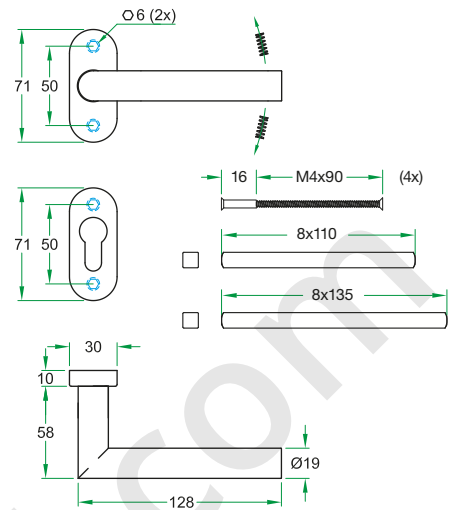

- RVS onderconstructie zonder nokken
- Kruk vastdraaibaar op rozet
- RVS mat geborsteld
- Incl. 2 vierkantstiften t.b.v. DD 37-77 mm
- Geschikt voor sloten met meerpuntsluiting



- Sous-construction inox sans pilier
- Béquille fixe avec ressort de retenue
- Inox mat brossé
- 2 Tiges carrée incl. pour EP 37-77 mm
- Approprié pour serrures multipoint



- Edelstahl Unterkonstruktion ohne Nocken
- Drücker festmontiert mit Hochhaltefeder
- Edelstahl matt gebürstet
- Einschl. 2 Vierkantstifte für TS 37-77 mm
- Geeignet für Mehrfachschlösser



- Stainless steel understructure without lugs
- Lever sprungloaded
- Satin stainless steel
- Incl. 2 spindles for doorthickness 37-77 mm
- Suitable for multipoint lock

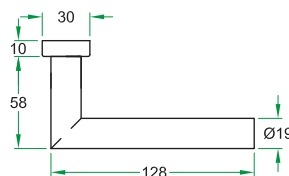
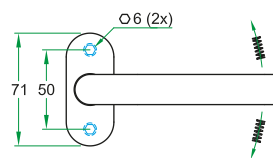

COMPONENTEN / COMPOSANTS / ZUBEHÖR / COMPONENTS

Profieldeurbeslag / Quincaillerie de porte pour châssis profilé / Schmalrahmen / Narrow profile door hardware



3K



- Exclusief schroeven
- RVS mat geborsteld



- Sans vis
- Inox mat brossé



- Ohne Schrauben
- Edelstahl matt gebürstet



- Screws excluded
- Brushed satin stainless steel

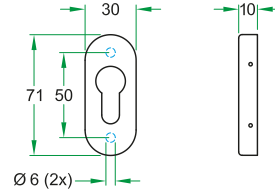

	05008
--	-------

ROZETTEN / ROSACES / ROSETTEN / ROSES

Profieldeur / Porte à chassis profil / Schmalrahmen / Profile door



- Massief RVS rozet
- Schuifstelsysteem
- Met kerntrekbeveiliging
- Exclusief bevestigingsmateriaal



- Rosace inox massif
- Système targette
- Avec protection de cylindre
- Fourni sans vis de fixation



- Massiv Edelstahl Rosette
- Schiebeseystem
- Mit Kernziehschutz
- Befestigungsmaterial nicht miteinbegriffen



- Solid stainless steel rose
- Sliding system
- With cylinder protector
- Fixing screws not included

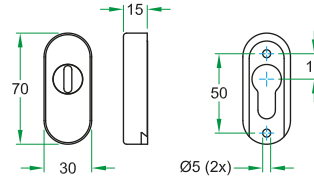

🔑	15 mm (H)	92455
---	-----------	-------



- Massief RVS rozet
- Schuifstelsysteem
- Exclusief bevestigingsmateriaal



- Rosace inox massif
- Système targette
- Fourni sans vis de fixation



- Massiv Edelstahl Rosette
- Schiebeseystem
- Befestigungsmaterial nicht miteinbegriffen



- Solid stainless steel rose
- Sliding system
- Fixing screws not included

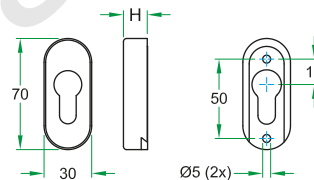

🔑	15 mm (H)	92452
	10 mm (H)	92451
	6 mm (H)	92450

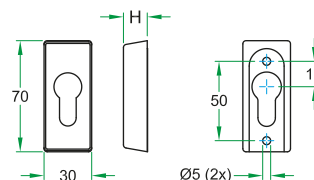

🔑	15 mm (H)	92462
	10 mm (H)	92461
	6 mm (H)	92460



Project: Kristal
Architect: De Architekten Cie.

 Buitendeuren

 Portes extérieures

 Außentüren

 Exterior doors



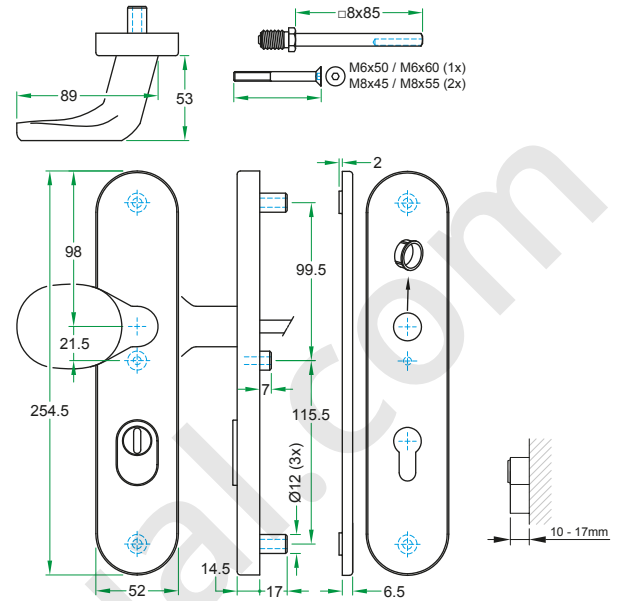
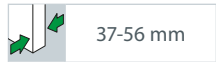
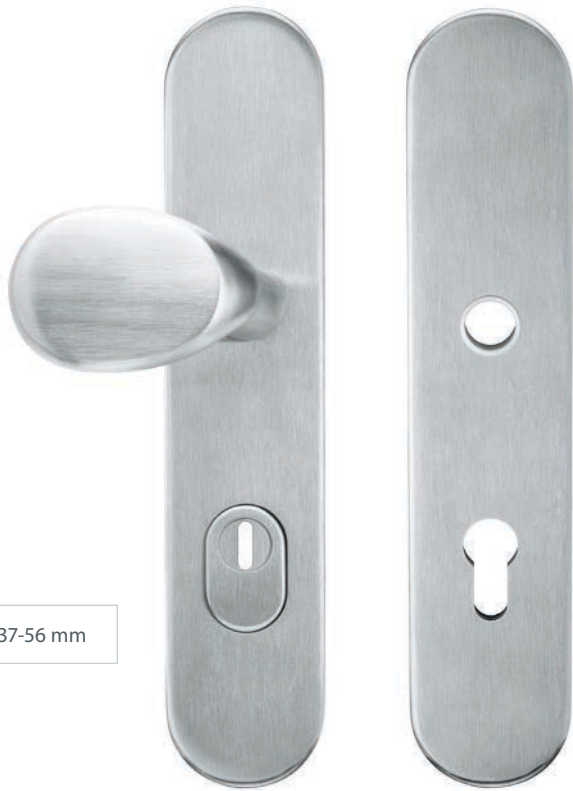

4B



- SKG ***
- Inbraakweerstand kerntrekbeveiliging overtreft SKG*** norm (> 20kN)
- Binnenschild met verdeckte schroefbevestiging
- RVS mat geborsteld
- Incl. 2 schroeven sets t.b.v. DD 37-56 mm
- Deurkruk separaat bestellen



- SKG***
- Resistance cambriolage de la protection de cylindre es supérieur à la norme de SKG*** (> 20kN)
- Plaque interieur avec vis invisible
- Inox mat brossé
- Incl. 2 set de vis pour EP 37-56 mm
- Béquille à commander séparément



- SKG***
- Einbruchwiderstand der Kernziehschutz übersteigt SKG*** Norm (>20kN)
- Innenschild mit verdeckter Schrauben
- Edelstahl matt gebürstet
- Einschl. 2 Schraubensätze für TS 37-56 mm
- Drücker separat bestellen



- SKG***
- Burglary resistance of cylinder protector supersedes SKG*** norm (>20kN)
- Interior plate with concealed screw fixing
- Satin stainless steel
- Incl. 2 screw sets for doorthickness 37-56 mm
- Order lever separately



			72 mm	26450/72
			92 mm	26450/92

	0981
--	------

	0982
--	------

	0983
--	------

4B

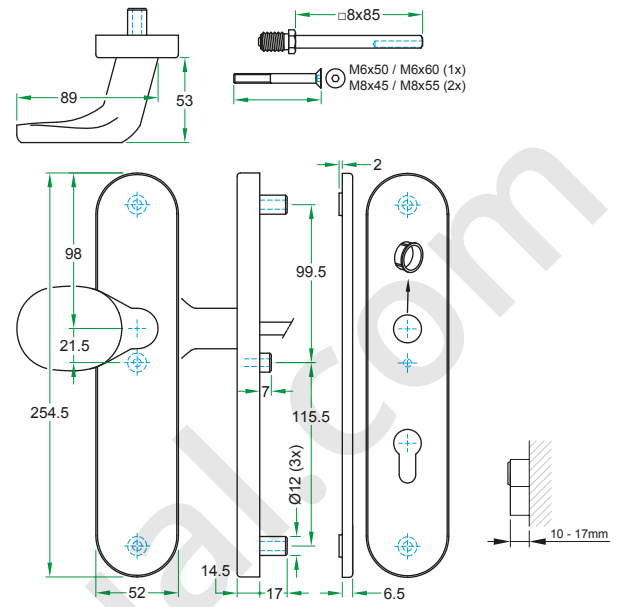
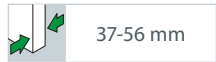
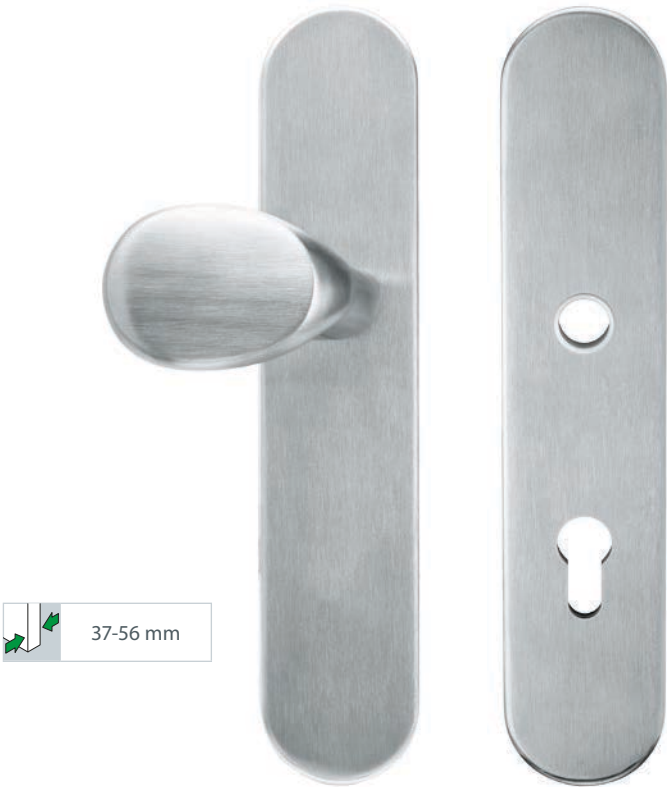

- SKG ***
- Binnenschild met verdeckte schroefbevestiging
- RVS mat geborsteld
- Incl. 2 schroeven sets t.b.v. DD 37-56 mm
- Deurkruk separaat bestellen



- SKG***
- Plaque interieur avec vis invisible
- Inox mat brossé
- Incl. 2 set de vis pour EP 37-56 mm
- Béquille à commander séparément



- SKG***
- Innenschild mit verdeckter Schrauben
- Edelstahl matt gebürstet
- Einschl. 2 Schraubensätze für TS 37-56 mm
- Drücker separat bestellen



- SKG***
- Interior plate with concealed screw fixing
- Satin stainless steel
- Incl. 2 screw sets for doorthickness 37-56 mm
- Order lever separately

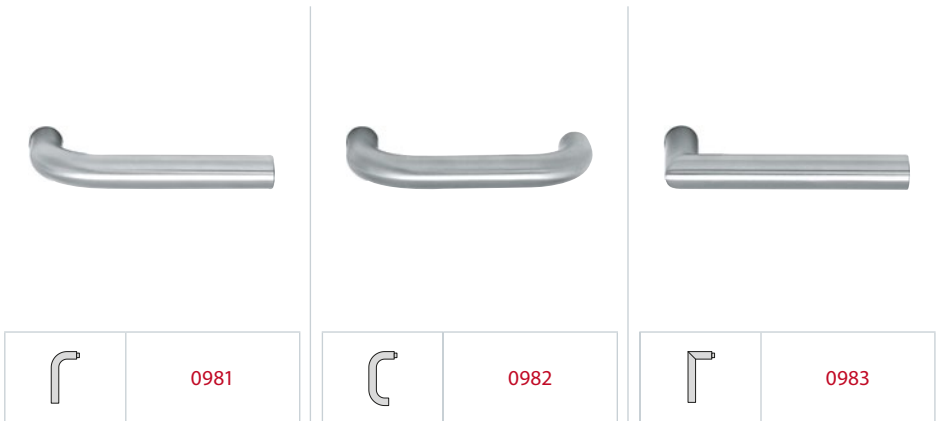

		72 mm	26452/72
		92 mm	26452/92

	0981
--	------

	0982
--	------

	0983
--	------

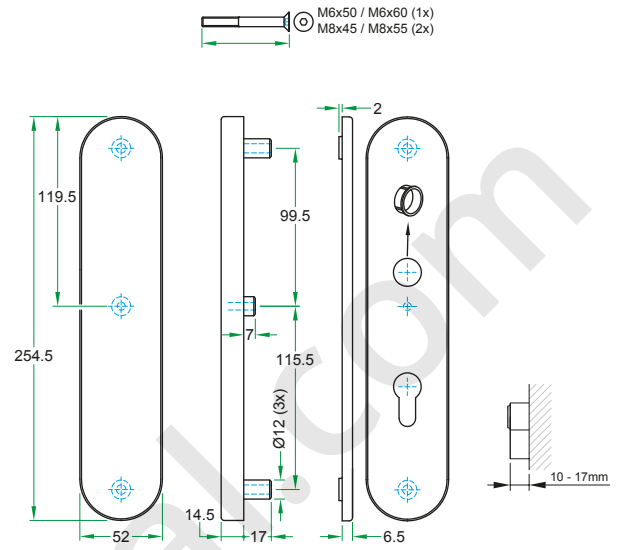
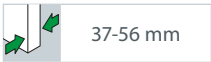
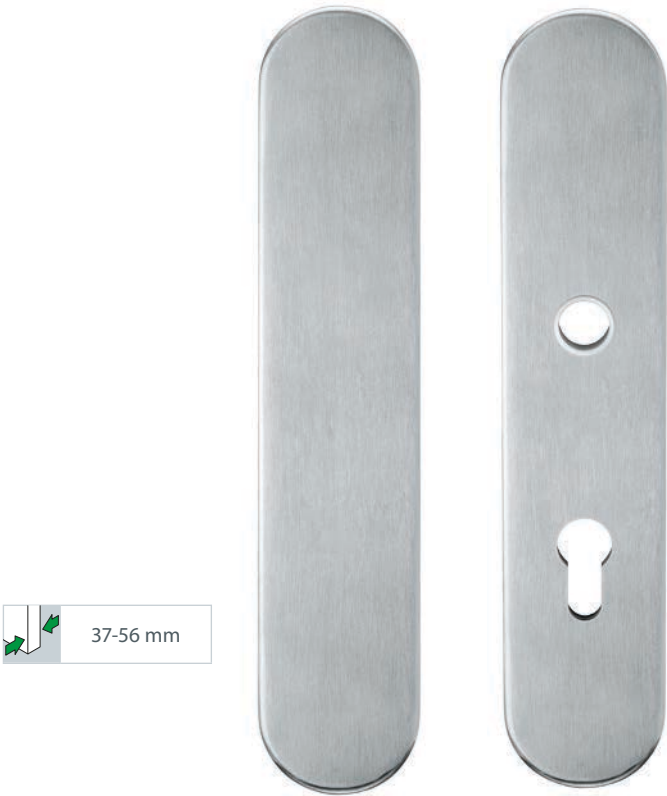

- SKG ***
- Binnenschild met verdeckte schroefbevestiging
- RVS mat geborsteld
- Incl. 2 schroeven sets t.b.v. DD 37-56 mm
- Deurkruk separaat bestellen



- SKG***
- Plaque interieur avec vis invisible
- Inox mat brossé
- Incl. 2 set de vis pour EP 37-56 mm
- Béquille à commander séparément



- SKG***
- Innenschild mit verdeckter Schrauben
- Edelstahl matt gebürstet
- Einschl. 2 Schraubensätze für TS 37-56 mm
- Drücker separat bestellen



- SKG***
- Interior plate with concealed screw fixing
- Satin stainless steel
- Incl. 2 screw sets for doorthickness 37-56 mm
- Order lever separately



		72 mm	26454/72
		92 mm	26454/92

	0981
--	------

	0982
--	------

	0983
--	------

	□ 8 x 61 mm		38 - 48 mm	93166
	□ 8 x 71 mm		49 - 59 mm	93167
	□ 8 x 82 mm		60 - 70 mm	93168
	□ 10 x 25 mm / □ 8 x 46 mm		49 - 59 mm	93213
	□ 10 x 25 mm / □ 8 x 57 mm		60 - 70 mm	93214

4B

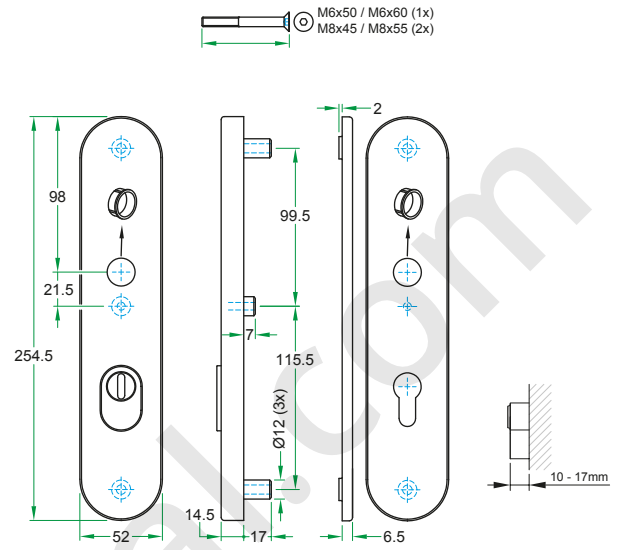
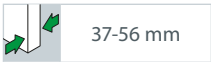

- SKG ***
- Inbraakweerstand kerntrekbeveiliging overtreft SKG*** norm (> 20kN)
- Binnenschild met verdeckte schroefbevestiging
- RVS mat geborsteld
- Incl. 2 schroeven sets t.b.v. DD 37-56 mm
- Deurkruk separaat bestellen



- SKG***
- Resistance cambriolage de la protection de cylindre es supérieur à la norme de SKG*** (> 20kN)
- Plaque interieur avec vis invisible
- Inox mat brossé
- Incl. 2 set de vis pour EP 37-56 mm
- Béquille à commander séparatement



- SKG***
- Einbruchwiderstand der Kernziehschutz übersteigt SKG*** Norm (>20kN)
- Innenschild mit verdeckter Schrauben
- Edelstahl matt gebürstet
- Einschl. 2 Schraubensätze für TS 37-56 mm
- Drücker separat bestellen



- SKG***
- Burglary resistance of cylinder protector supersedes SKG*** norm (>20kN)
- Interior plate with concealed screw fixing
- Satin stainless steel
- Incl. 2 screw sets for doorthickness 37-56 mm
- Order lever separately



		72 mm	26451/72
		92 mm	26451/92

	0980
--	------

	0984
--	------

	0985
--	------

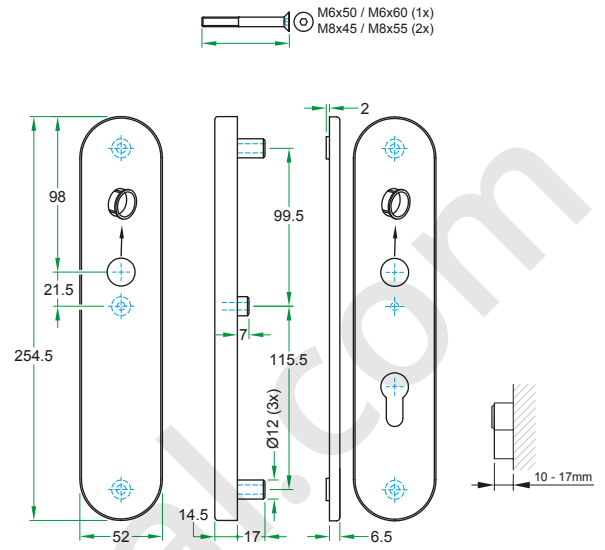
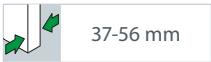
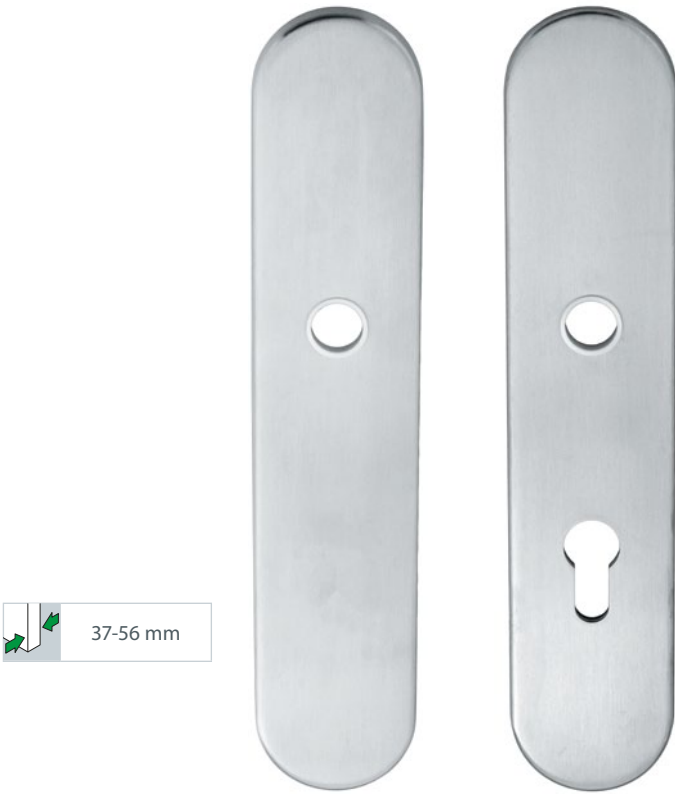

4B



- SKG ***
- Inbraakweerstand kerntrekbeveiliging overtreft SKG*** norm (> 20kN)
- Binnenschild met verdeckte schroefbevestiging
- RVS mat geborsteld
- Incl. 2 schroeven sets t.b.v. DD 37-56 mm
- Deurkruk separaat bestellen



- SKG***
- Resistance cambriolage de la protection de cylindre es supérieur à la norme de SKG*** (> 20kN)
- Plaque interieur avec vis invisible
- Inox mat brossé
- Incl. 2 set de vis pour EP 37-56 mm
- Béquille à commander séparément



- SKG***
- Einbruchwiderstand der Kernziehschutz übersteigt SKG*** Norm (>20kN)
- Innenschild mit verdeckter Schrauben
- Edelstahl matt gebürstet
- Einschl. 2 Schraubensätze für TS 37-56 mm
- Drücker separat bestellen



- SKG***
- Burglary resistance of cylinder protector supersedes SKG*** norm (>20kN)
- Interior plate with concealed screw fixing
- Satin stainless steel
- Incl. 2 screw sets for doorthickness 37-56 mm
- Order lever separately

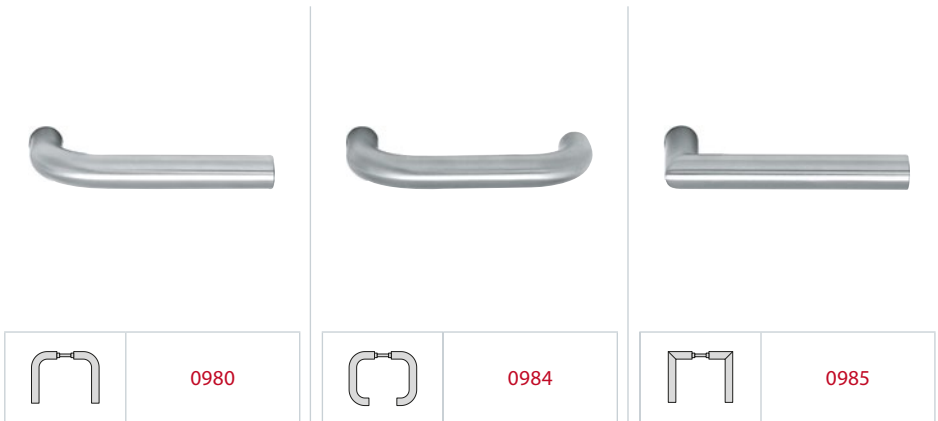

		72 mm	26453/72
		92 mm	26453/92

	0980
--	------

	0984
--	------

	0985
--	------

COMPONENTEN / COMPOSANTS / ZUBEHÖR / COMPONENTS

Veiligheidsbeslag / Quincaillerie de sécurité / Schutzbeschläge / Security Hardware
Binnenschilden / Plaques interieur / Innenschilder / Interior plates

4B

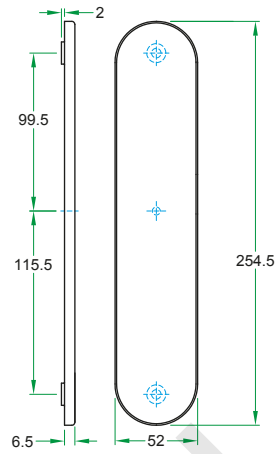

26455

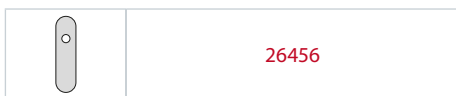
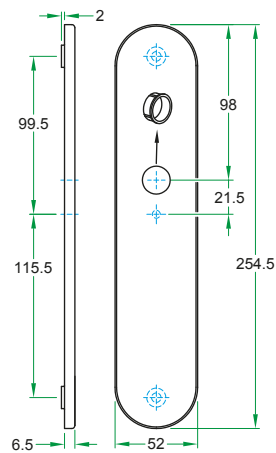

26456

-   **TOP ONDERDELEN** Verlengde stiften en schroeven
-   **TOP ACCESSOIRES** Tiges e vis allongées
-  **TOP ZUBEHÖR** verlängerte Stifte und Schrauben
-  **TOP PARTS** extended spindles and screws



Schroeven
Vis
Schrauben
Screws

Stift
Tige carrée
Stift
Spindle

Artikelnr.
Code d'article
Artikelnr.
Article code

TOP • Knop/kruk SKG3 schilden • Plaques bouton/béquille SKG3 • Knopf/Drücker Schilder SKG3 • Knob/lever plates SKG3

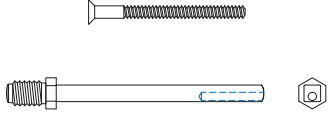
	37-46 mm	inclusief/inclus zuzüglich/included	inclusief/inclus zuzüglich/included	
	47-56 mm	inclusief/inclus zuzüglich/included	inclusief/inclus zuzüglich/included	
	57-66 mm	1x M6 x 70 mm 2x M8 x 60 mm	M12/□8 x 89 mm	TW5766
	70 mm	1x M6 x 80 mm 2x M8 x 70 mm	M12/□8 x 99 mm	TW70
	80 mm	1x M6 x 90 mm 2x M8 x 80 mm	M12/□8 x 125 mm	TW80

4B

TOP • Kruk/kruk SKG3 schilden • Plaques béquille/béquille SKG3 • Drücker/Drücker Schilder SKG3 • Lever/lever plates SKG3

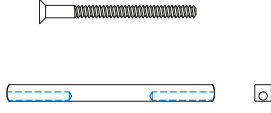
	37-46 mm	inclusief/inclus zuzüglich/included	□ 8 x 110 mm*	93156
	47-56 mm	inclusief/inclus zuzüglich/included	□ 8 x 130 mm	93202
	57-66 mm	1x M6 x 70 mm 2x M8 x 60 mm	□ 8 x 155 mm	TK5766 + 97717



Stift
Tige carrée
Stift
Spindle

Artikelnr.
Code d'article
Artikelnr.
Article code

	38 - 48 mm	□ 8 x 61 mm	93166
	49 - 59 mm	□ 8 x 71 mm	93167
	60 - 70 mm	□ 8 x 82 mm	93168
	49 - 59 mm	□ 10 x 25 mm / □ 8 x 46 mm	93213
	60 - 70 mm	□ 10 x 25 mm / □ 8 x 57 mm	93214

* Deurkrukparen 0980-0984-0985 zijn standaard voorzien van stift 8 x 110 mm.

* Les béquilles 0980-0984-0985 sont fourni standard avec tige carrée 8 x 110 mm.

* Drückerpaare 0980-0984-0985 sind standard versehen mit Vierkantstift 8 x 110 mm.

* Lever pair 0980-0984-0985 are standard provided with square spindle 8 x 110 mm.



PRIO

Veiligheidsbeslag / Quincaillerie de sécurité / Schutzbeschläge / Security Hardware

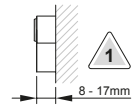
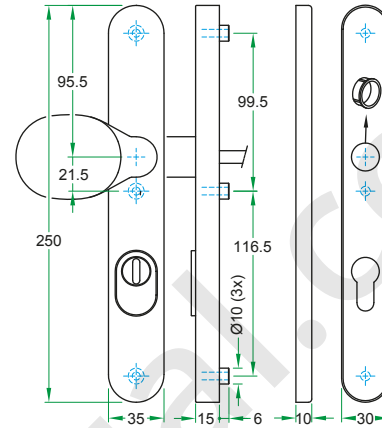
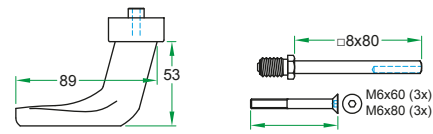

- SKG***
- Massief RVS buitenschild 35 mm (B)
- Inbraakweerstand kerntrekbeveiliging overtreft SKG*** norm (> 20kN)
- Binnenschild 30 mm(B) met verdeckte schroefbevestiging
- RVS mat geborsteld
- Incl. 2 schroevensets tbv DD 47-77 mm
- Deurkruk separaat bestellen



- SKG***
- Plaque extérieure inox massif 35 mm (L)
- Résistance cambriolage de la protection de cylindre es supérieur à la norme de SKG*** (> 20kN)
- Plaque intérieur 30 mm (L) avec vis invisible
- Inox mat brossé
- Incl. 2 set de vis pour EP 47-77 mm
- Béquille à commander séparément



- SKG***
- Massives Edelstahl Außenschild 35 mm (B)
- Einbruchwiderstand der Kernziehschutz übersteigt SKG*** Norm (>20kN)
- Innenschild 30 mm (B) mit verdeckter Schrauben
- Edelstahl matt gebürstet
- Einschl. 2 Schraubensätze für TS 47-77 mm
- Drücker separat bestellen



- SKG***
- Solid stainless steel exterior plate 35 mm (W)
- Burglary resistance of cylinder protector supersedes SKG*** norm (>20kN)
- Interior plate 30 mm(W) with concealed screw fixing
- Satin stainless steel
- Incl. 2 screw sets for doorthickness 47-77 mm
- Order lever separately



		72 mm	26300/72
		92 mm	26300/92

	0981
--	------

	0982
--	------

	0983
--	------

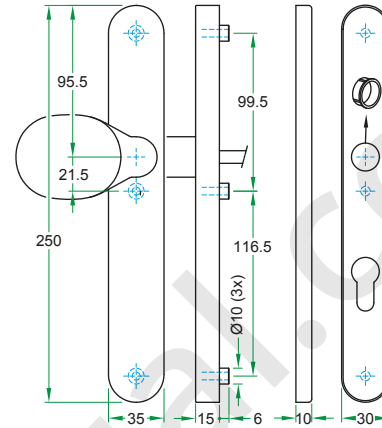
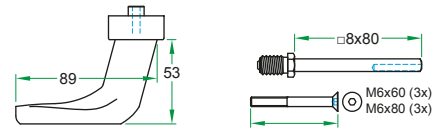

- SKG***
- Massief RVS buitenschild 35 mm (B)
- Binnenschild 30 mm(B) met verdeckte schroefbevestiging
- RVS mat geborsteld
- Incl. 2 schroeven sets tbv DD 47-77 mm
- Deurkruk separaat bestellen



- SKG***
- Plaque extérieur inox massif 35 mm (L)
- Plaque intérieur 30 mm (L) avec vis invisible
- Inox mat brossé
- Incl. 2 set de vis pour EP 47-77 mm
- Béquille à commander séparément



- SKG***
- Massives Edelstahl Außenschild 35 mm (B)
- Innenschild 30 mm (B) mit verdeckter Schrauben
- Edelstahl matt gebürstet
- Einschl. 2 Schraubensätze für TS 47-77 mm
- Drücker seperat bestellen



- SKG***
- Solid stainless steel exterior plate 35 mm (W)
- Interior plate 30 mm(W) with concealed screw fixing
- Satin stainless steel
- Incl. 2 screw sets for doorthickness 47-77 mm
- Order lever seperately



		72 mm	26302/72
		92 mm	26302/92

	0981
--	------

	0982
--	------

	0983
--	------

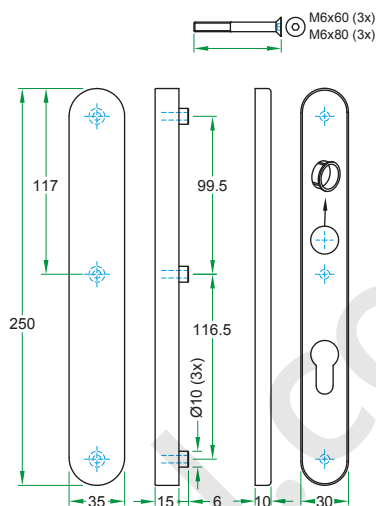

- SKG***
- Massief RVS buitenschild 35 mm (B)
- Binnenschild 30 mm(B) met verdeckte schroefbevestiging
- RVS mat geborsteld
- Incl. 2 schroeven sets tbv DD 47-77 mm
- Deurkruk separaat bestellen



- SKG***
- Plaque extérieur inox massif 35 mm (L)
- Plaque intérieur 30 mm (L) avec vis invisible
- Inox mat brossé
- Incl. 2 set de vis pour EP 47-77 mm
- Béquille à commander séparément



- SKG***
- Massives Edelstahl Außenschild 35 mm (B)
- Innenschild 30 mm (B) mit verdeckter Schrauben
- Edelstahl matt gebürstet
- Einschl. 2 Schraubensätze für TS 47-77 mm
- Drücker separat bestellen



- SKG***
- Solid stainless steel exterior plate 35 mm (W)
- Interior plate 30 mm(W) with concealed screw fixing
- Satin stainless steel
- Incl. 2 screw sets for doorthickness 47-77 mm
- Order lever separately



		72 mm	26304/72
		92 mm	26304/92

	0981
--	------

	0982
--	------

	0983
--	------

	□ 8 x 61 mm		38 - 48 mm	93166
	□ 8 x 71 mm		49 - 59 mm	93167
	□ 8 x 82 mm		60 - 70 mm	93168
	□ 10 x 25 mm / □ 8 x 46 mm		49 - 59 mm	93213
	□ 10 x 25 mm / □ 8 x 57 mm		60 - 70 mm	93214

4C

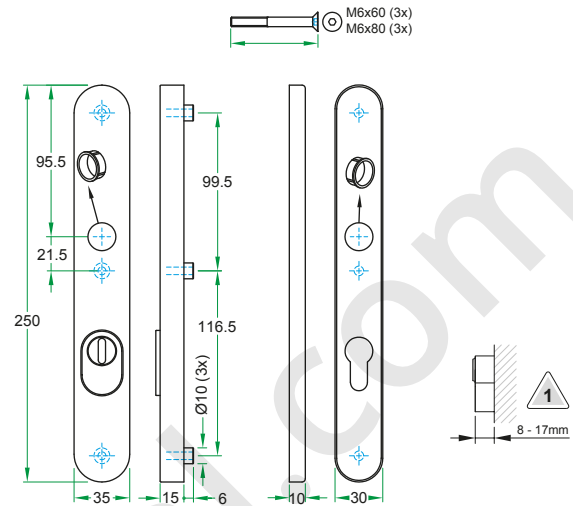

- SKG***
- Massief RVS buitenschild 35 mm (B)
- Inbraakweerstand kerntrekbeveiliging overtreft SKG*** norm (> 20kN)
- Binnenschild 30 mm(B) met verdeckte schroefbevestiging
- RVS mat geborsteld
- Incl. 2 schroeven sets tbv DD 47-77 mm
- Deurkruk separaat bestellen



- SKG***
- Plaque extérieure inox massif 35 mm (L)
- Resistance cambriolage de la protection de cylindre es supérieur à la norme de SKG*** (> 20kN)
- Plaque interieur 30 mm (L) avec vis invisible
- Inox mat brossé
- Incl. 2 set de vis pour EP 47-77 mm
- Béquille à commander séparément



- SKG***
- Massives Edelstahl Außenschild 35 mm (B)
- Einbruchwiderstand der Kernziehschutz übersteigt SKG*** Norm (>20kN)
- Innenschild 30 mm (B) mit verdeckter Schrauben
- Edelstahl matt gebürstet
- Einschl. 2 Schraubensätze für TS 47-77 mm
- Drücker separat bestellen



- SKG***
- Solid stainless steel exterior plate 35 mm (W)
- Burglary resistance of cylinder protector supersedes SKG*** norm (>20kN)
- Interior plate 30 mm(W) with concealed screw fixing
- Satin stainless steel
- Incl. 2 screw sets for doorthickness 47-77 mm
- Order lever separately

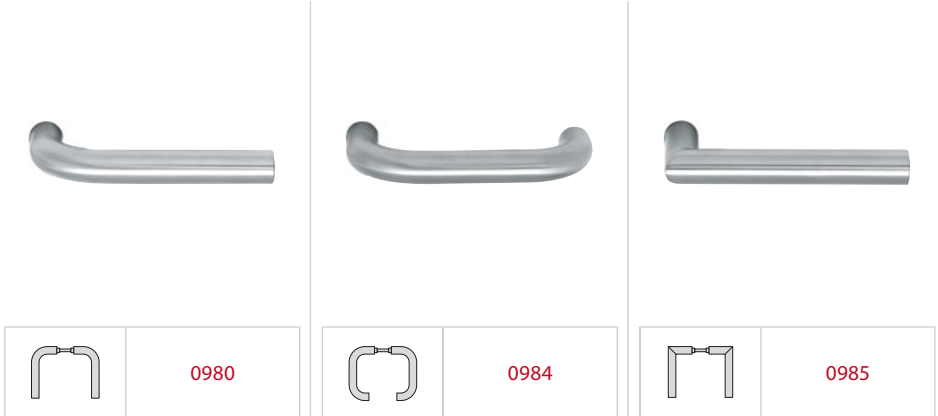

		72 mm	26301/72
		92 mm	26301/92

	0980
--	------

	0984
--	------

	0985
--	------

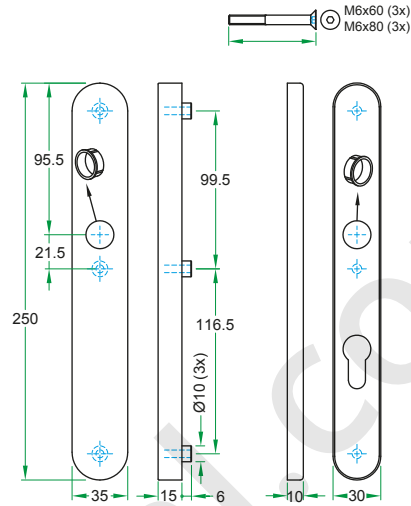

- SKG***
- Massief RVS buitenschild 35 mm (B)
- Binnenschild 30 mm(B) met verdeckte schroefbevestiging
- RVS mat geborsteld
- Incl. 2 schroeven sets tbv DD 47-77 mm
- Deurkruk separaat bestellen



- SKG***
- Plaque extérieur inox massif 35 mm (L)
- Plaque intérieur 30 mm (L) avec vis invisible
- Inox mat brossé
- Incl. 2 set de vis pour EP 47-77 mm
- Béquille à commander séparément



- SKG***
- Massives Edelstahl Außenschild 35 mm (B)
- Innenschild 30 mm (B) mit verdeckter Schrauben
- Edelstahl matt gebürstet
- Einschl. 2 Schraubensätze für TS 47-77 mm
- Drücker separat bestellen



- SKG***
- Solid stainless steel exterior plate 35 mm (W)
- Interior plate 30 mm(W) with concealed screw fixing
- Satin stainless steel
- Incl. 2 screw sets for doorthickness 47-77 mm
- Order lever seperately



		72 mm	26303/72
		92 mm	26303/92

	0980
--	------

	0984
--	------

	0985
--	------

COMPONENTEN / COMPOSANTS / ZUBEHÖR / COMPONENTS

Veiligheidsbeslag / Quincaillerie de sécurité / Schutzbeschläge / Security Hardware
Binnenschilden / Plaques interieur / Innenschilder / Interior plates

4C

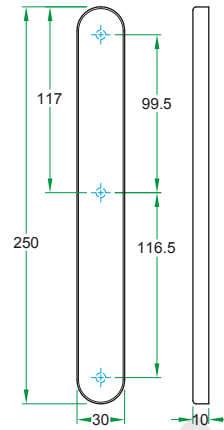

26306

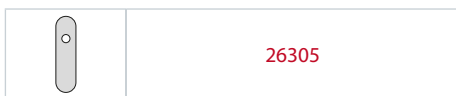
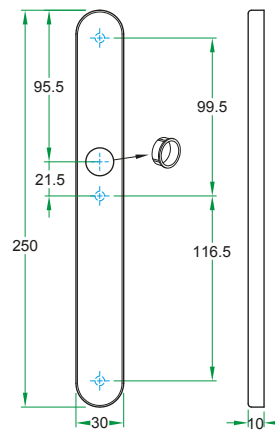

26305

-   **PRIO ONDERDELEN Verlengde stiften en schroeven**
-   **PRIO ACCESSOIRES Tiges e vis allongées**
-  **PRIO ZUBEHÖR verlängerte Stifte und Schrauben**
-  **PRIO PARTS extended spindles and screws**



Schroeven
Vis
Schrauben
Screws

Stift
Tige carrée
Stift
Spindle

Artikelnr.
Code d'article
Artikelnr.
Article code

PRIO • Knop/kruk SKG3 schilden • Plaques bouton/béquille SKG3 • Knopf/Drücker Schilder SKG3 • Knob/lever plates SKG3

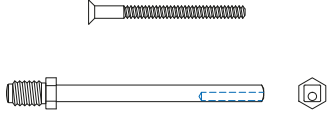
	47-57 mm	inclusief/inclus zuzüglich/included	inclusief/inclus zuzüglich/included	
	67-77 mm	inclusief/inclus zuzüglich/included	inclusief/inclus zuzüglich/included	
	39-46 mm	3x M6 x 50 mm	M12/□8 x 80 mm	PW3946
	57-66 mm	3x M6 x 70 mm	inclusief/inclus zuzüglich/included	PW5766
	84-91 mm	3x M6 x 90 mm	M12/□8 x 120 mm	PW8491

4C

PRIO • Kruk/kruk SKG3 schilden • Plaques béquille/béquille SKG3 • Drücker/Drücker Schilder SKG3 • Lever/lever plates SKG3

	47-57 mm	inclusief/inclus zuzüglich/included	□ 8 x 130 mm	93111
	67-77 mm	inclusief/inclus zuzüglich/included	□ 8 x 150 mm	
	39-46 mm	3x M6 x 50 mm	□ 8 x 110 mm*	PK3946 + 93156
	57-66 mm	3x M6 x 70 mm	□ 8 x 140 mm	PK5766 + 93156-140
	84-91 mm	3x M6 x 90 mm	□ 8 x 155 mm	PK8491 + 97717



Stift
Tige carrée
Stift
Spindle

Artikelnr.
Code d'article
Artikelnr.
Article code

	38 - 48 mm		□ 8 x 61 mm	93166
	49 - 59 mm		□ 8 x 71 mm	93167
	60 - 70 mm		□ 8 x 82 mm	93168
	49 - 59 mm		□ 10 x 25 mm / □ 8 x 46 mm	93213
	60 - 70 mm		□ 10 x 25 mm / □ 8 x 57 mm	93214

* Deurkrukparen 0980-0984-0985 zijn standaard voorzien van stift 8 x 110 mm.

* Les béquilles 0980-0984-0985 sont fourni standard avec tige carrée 8 x 110 mm.

* Drückerpaare 0980-0984-0985 sind standard versehen mit Vierkantstift 8 x 110 mm.

* Lever pair 0980-0984-0985 are standard provided with square spindle 8 x 110 mm.

COMPONENTEN / COMPOSANTS / ZUBEHÖR / COMPONENTS

Deurkruk / Béquille / Drücker / Lever

4C



	0980
	0981



- Geschikt voor veiligheidsbeslag
- RVS mat geborsteld



- Apte pour quincaillerie de sécurité
- Inox mat brossé



- Geeignet für Schutzbeschläge
- Edelstahl matt gebürstet



- Suitable for security hardware
- Satin stainless steel

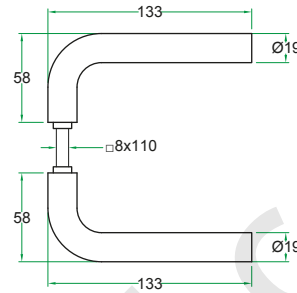

- Geschikt voor veiligheidsbeslag
- RVS mat geborsteld



- Apte pour quincaillerie de sécurité
- Inox mat brossé



- Geeignet für Schutzbeschläge
- Edelstahl matt gebürstet



- Suitable for security hardware
- Satin stainless steel



	0984
	0982

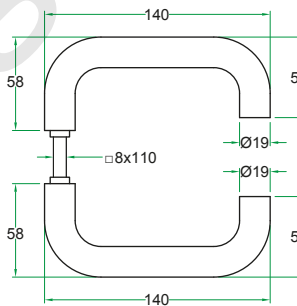

- Geschikt voor veiligheidsbeslag
- RVS mat geborsteld



- Apte pour quincaillerie de sécurité
- Inox mat brossé



- Geeignet für Schutzbeschläge
- Edelstahl matt gebürstet



- Suitable for security hardware
- Satin stainless steel

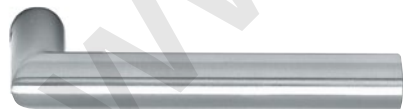

	0985
	0983

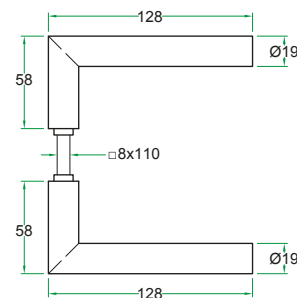

COMPONENTEN / COMPOSANTS / ZUBEHÖR / COMPONENTS

Knop / Bouton / Knopf / Knob

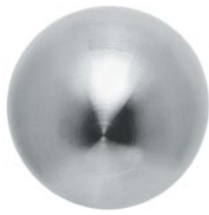

- Draaibaar
- RVS mat geborsteld



- Tournant
- Inox mat brossé



- Drehbar
- Edelstahl matt gebürstet



- Turnable
- Brushed satin stainless steel

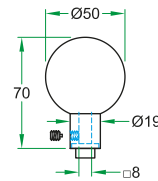

96181/R



- Draaibaar
- RVS mat geborsteld



- Tournant
- Inox mat brossé



- Drehbar
- Edelstahl matt gebürstet



- Turnable
- Brushed satin stainless steel

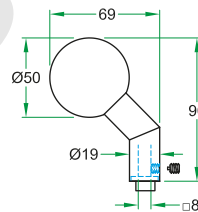

96183/R



- Draaibaar
- RVS mat geborsteld



- Tournant
- Inox mat brossé



- Drehbar
- Edelstahl matt gebürstet



- Turnable
- Brushed satin stainless steel

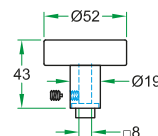

67102/R



NOVA

Veiligheidsrozetten / Rosaces de sécurité / Schutzrosetten / Security roses

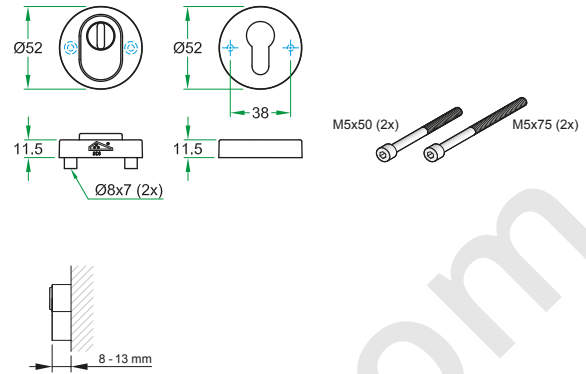

	ES92351
--	----------------

	40-47 mm	65-72 mm
--	----------	----------



- SKG***
- Inbraakweerstand kerntrekbeveiliging overtreft SKG*** norm (>20kN)
- DIN 18257 ES1
- Binnenrozet met verdeckte schroefbevestiging
- RVS mat geborsteld
- Incl. 2 schroeven sets M5 t.b.v DD 40-47 mm en DD 65-72 mm



- SKG***
- Resistance cambriolage de la protection de cylindre es supérieur à la norme de SKG*** (>20kN)
- DIN 18257 ES1
- Rosace interieur avec vis invisible
- Inox mat brossé
- Incl. 2 set de vis M5 pour EP 40-47 mm et EP 65-72 mm



- SKG***
- Einbruchwiderstand der Kernziehschutz SKG*** Norm (>20kN)
- DIN 18257 ES1
- Innenrosette mit verdeckter Schrauben
- Edelstahl matt gebürstet
- Einschl. 2 Schraubensätze M5 für TS 40-47 mm und TS 65-72 mm



- SKG***
- Burglary resistance of cylinder protector superseded SKG*** Norm (>20kN)
- DIN 18257 ES1
- Interior rose with invisible screws
- Satin stainless steel
- Incl. 2 screw sets M5 for DT 40-47 mm and DT 65-72 mm

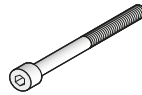

Schroeven
Vis
Schrauben
Screws

Artikelnr.
Code d'article
Artikelnr.
Article code

50-57,5 mm	M5 x 60 mm	93175
60-67,5 mm	M5 x 70 mm	93173
70-77,5 mm	M5 x 80 mm	93176
80-87 mm	M5 x 90 mm	93174

	ES92351
	93291

4D

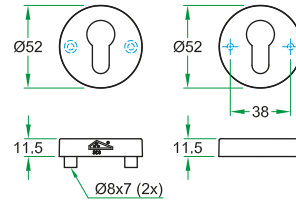

4D

① ①	ES92349
-----	---------

	40-47 mm	65-72 mm
--	----------	----------



- SKG***
- Inbraakweerstand kerntrekbeveiliging overtreft SKG*** norm (>20kN)
- DIN 18257 ES1
- Binnenrozet met verdeckte schroefbevestiging
- RVS mat geborsteld
- Incl. 2 schroeven sets M5 t.b.v DD 40-47 mm en DD 65-72 mm



- SKG***
- Resistance cambriolage de la protection de cylindre es supérieur à la norme de SKG*** (>20kN)
- DIN 18257 ES1
- Rosace interieur avec vis invisible
- Inox mat brossé
- Incl. 2 set de vis M5 pour EP 40-47 mm et EP 65-72 mm



- SKG***
- Einbruchwiderstand der Kernziehschutz SKG*** Norm (>20kN)
- DIN 18257 ES1
- Innenrosette mit verdeckter Schrauben
- Edelstahl matt gebürstet
- Einschl. 2 Schraubensätze M5 für TS 40-47 mm und TS 65-72 mm



- SKG***
- Burglary resistance of cylinder protector supersedes SKG*** Norm (>20kN)
- DIN 18257 ES1
- Interior rose with invisible screws
- Satin stainless steel
- Incl. 2 screw sets M5 for DT 40-47 mm and DT 65-72 mm

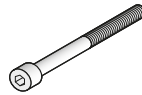

Schroeven
Vis
Schrauben
Screws

Artikelnr.
Code d'article
Artikelnr.
Article code

50-57,5 mm	M5 x 60 mm	93175
60-67,5 mm	M5 x 70 mm	93173
70-77,5 mm	M5 x 80 mm	93176
80-87 mm	M5 x 90 mm	93174

① ①	ES92349
○ ①	93290

 Profieldeur rozetten

 Porte à chassis profil rosaces

 Schmalrahmen Rosetten

 Profile door roses

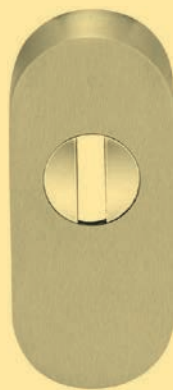



Rozetten / Rosaces / Rosetten / Roses

Profieldeur rozetten / Porte à chassis profil rosaces / Schmalrahmen Rosetten / Profile door roses



- Massief RVS rozet
- Schuifstelsysteem
- Met kerntrek-beveiliging
- Exclusief bevestigingsmateriaal



- Rosace inox massif
- Système targette
- Avec protection de cylindre
- Fourni sans vis de fixation



- Massiv Edelstahl Rosette
- Schiebeseystem
- Mit Kernziehschutz
- Befestigungsmaterial nicht miteinbegriffen



- Solid stainless steel rose
- Sliding system
- With cylinder protector
- Fixing screws not included

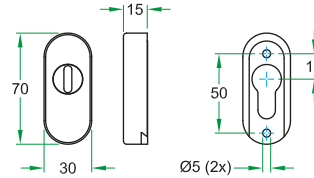

🔒	15 mm (H)	92455
---	-----------	-------



- Massief RVS rozet
- Schuifstelsysteem
- Exclusief bevestigingsmateriaal



- Rosace inox massif
- Système targette
- Fourni sans vis de fixation



- Massiv Edelstahl Rosette
- Schiebeseystem
- Befestigungsmaterial nicht miteinbegriffen



- Solid stainless steel rose
- Sliding system
- Fixing screws not included

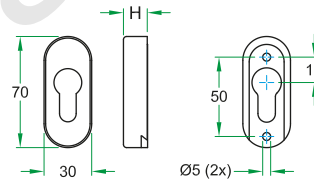

🔒	15 mm (H)	92452
	10 mm (H)	92451
	6 mm (H)	92450



- Massief RVS rozet
- Schuifstelsysteem
- Exclusief bevestigingsmateriaal



- Rosace inox massif
- Système targette
- Fourni sans vis de fixation



- Massiv Edelstahl Rosette
- Schiebeseystem
- Befestigungsmaterial nicht miteinbegriffen



- Solid stainless steel rose
- Sliding system
- Fixing screws not included

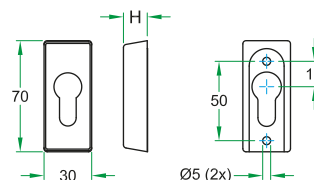

🔒	15 mm (H)	92462
	10 mm (H)	92461
	6 mm (H)	92460



  Voordeurbeslag

  Garnitures de portes

 Haustürbeschläge

 Entrance hardware

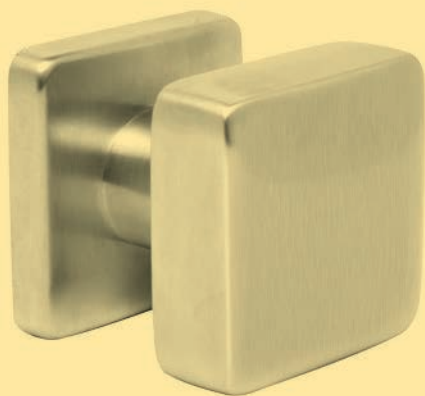

Voordeur / Porte d'entrée / Haustür / Entry door



- RVS deurkruk vastdraaibaar met dubbelwerkende veer
- Stalen onderconstructie zonder nokken
- Geschikt voor meerpuntsluiting
- RVS mat geborsteld
- Sleutel rozetten separaat bestellen



- Béquille inox avec ressort de retenue à double sens
- Sous-construction en acier sans cames
- Approprié pour serrures multipoints
- Inox mat brossé
- Rosaces du clef à commander séparément



- Edelstahl Drücker festdrehbar mit doppeltätigem Hochhaltefeder
- Stahl Unterkonstruktion ohne nocken
- Geeignet für Mehrfachverriegelung
- Edelstahl matt gebürstet
- Schlüssel rosetten separat bestellen



- Stainless steel lever sprungloaded with double working spring
- Steel understructure without lugs
- Suitable for multipoint locks
- Satin stainless steel
- Order escutcheons separately

4G

Cecil

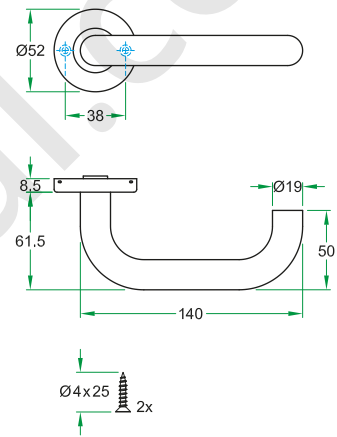

Leona

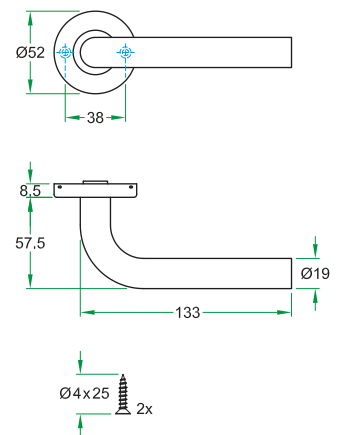

Voordeur / Porte d'entrée / Haustür / Entry door



- RVS deurkruk vastdraaibaar met dubbelwerkende veer
- Stalen onderconstructie zonder nokken
- Geschikt voor meerpuntsluiting
- RVS mat geborsteld
- Sleutel rozetten separaat bestellen



- Béquille inox avec ressort de retenue à double sens
- Sous-construction en acier sans cames
- Approprié pour serrures multipoints
- Inox mat brossé
- Rosaces du clef à commander séparément



- Edelstahl Drücker festdrehbar mit doppeltätigem Hochhaltefeder
- Stahl Unterkonstruktion ohne nocken
- Geeignet für Mehrfachverriegelung
- Edelstahl matt gebürstet
- Schlüssel rosetten separat bestellen



- Stainless steel lever sprungloaded with double working spring
- Steel understructure without lugs
- Suitable for multipoint locks
- Satin stainless steel
- Order escuteons separately

Tavira

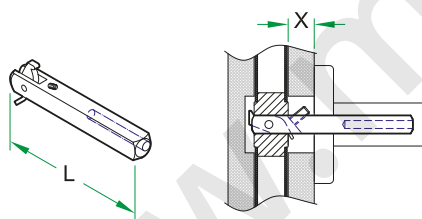
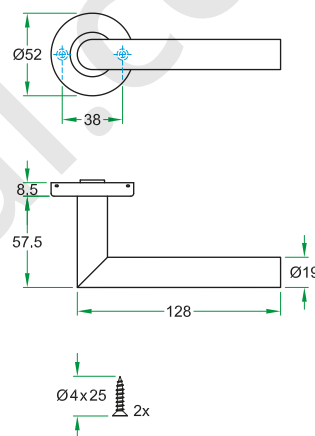

		L	X min	X max
93167	□ 8 mm excentric	71mm	12mm	36mm
93168	□ 8 mm excentric	82mm	23mm	47mm

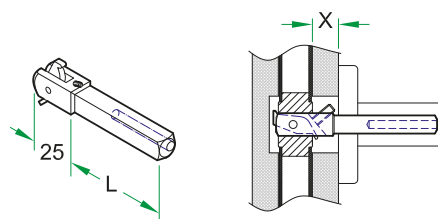

		L	X min	X max
93213	□ 10/8mm excentric	46mm	12mm	36mm
93214	□ 10/8mm excentric	57mm	23mm	47mm



Stift
Tige carrée
Stift
Spindle

Artikelnr.
Code d'article
Artikelnr.
Article code

	38 - 48 mm	□ 8 x 61 mm	93166
	49 - 59 mm	□ 8 x 71 mm	93167
	60 - 70 mm	□ 8 x 82 mm	93168
	49 - 59 mm	□ 10 x 25 mm / □ 8 x 46 mm	93213
	60 - 70 mm	□ 10 x 25 mm / □ 8 x 57 mm	93214

Voordeur / Porte d'entrée / Haustür / Entry door

Entro 50



- RVS voordeurknop Ø 50 mm
- Mat geborsteld
- Doorgaande bevestiging of op rozet



- Bouton porte d'entrée Ø 50 mm
- Mat brossé
- Fixation traversante ou sur rosace



- Edelstahl Haustürknoopf Ø 50 mm
- Matt gebürstet
- Einseitige durchgehende Befestigung oder auf Rosette



- Stainless steel entry door knob Ø 50 mm
- Satin finish
- Single sided bolt-thru fixing or on rose

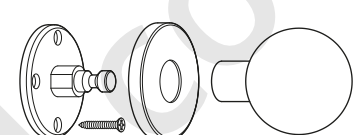
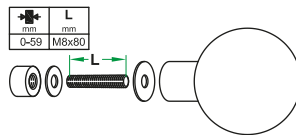
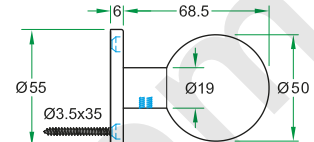
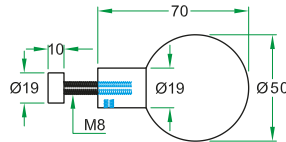

	93245
	93246

Entro 67



- RVS voordeurknop Ø 67 mm
- Mat geborsteld
- Doorgaande bevestiging



- Bouton porte d'entrée Ø 67 mm
- Mat brossé
- Fixation traversante



- Edelstahl Haustürknoopf Ø 67 mm
- Matt gebürstet
- Einseitige durchgehende Befestigung



- Stainless steel entry door knob Ø 67 mm
- Satin finish
- Single sided bolt-thru fixing

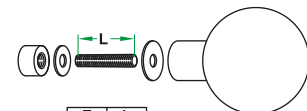
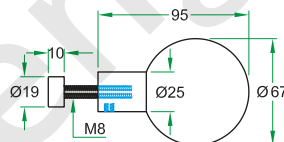

	93247
--	-------

Star



- RVS voordeurknop Ø 50 mm
- Mat geborsteld
- Doorgaande bevestiging of op rozet



- Bouton porte d'entrée Ø 50 mm
- Mat brossé
- Fixation traversante ou sur rosace



- Edelstahl Haustürknoopf Ø 50 mm
- Matt gebürstet
- Einseitige durchgehende Befestigung oder auf Rosette



- Stainless steel entry door knob Ø 50 mm
- Satin finish
- Single sided bolt-thru fixing or on rose

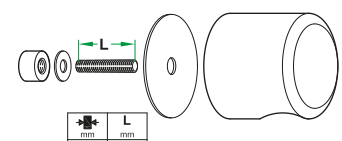
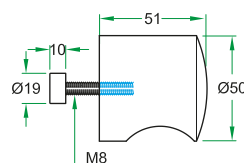

	93275
	93274

Voordeur / Porte d'entrée / Haustür / Entry door

Luna



- RVS voordeurknop Ø 50 mm
- Mat geborsteld
- Doorgaande bevestiging



- Bouton porte d'entrée Ø 50 mm
- Mat brossé
- Fixation traversante



- Edelstahl Haustürknopf Ø 50 mm
- Matt gebürstet
- Einseitige durchgehende Befestigung



- Stainless steel entry door knob Ø 50 mm
- Satin finish
- Single sided bolt-thru fixing

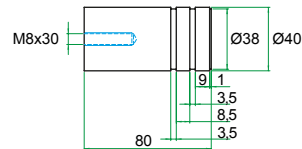

93283

Orion



- RVS voordeurknop Ø 70 mm
- Mat geborsteld
- Doorgaande bevestiging



- Bouton porte d'entrée Ø 70 mm
- Mat brossé
- Fixation traversante



- Edelstahl Haustürknopf Ø 70 mm
- Matt gebürstet
- Einseitige durchgehende Befestigung



- Stainless steel entry door knob Ø 70 mm
- Satin finish
- Single sided bolt-thru fixing

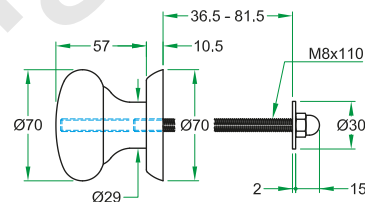

93423

Quadra



- RVS voordeurknop □ 62 x 30 mm op rozet □ 62,5 mm
- Mat geborsteld
- Doorgaande bevestiging of op rozet



- Bouton porte d'entrée □ 62 x 30 mm sur rosace □ 62,5 mm
- Mat brossé
- Fixation traversante ou sur rosace



- Edelstahl Haustürknopf □ 62 x 30 mm auf Rosette □ 62,5 mm
- Matt gebürstet
- Einseitige durchgehende Befestigung oder auf Rosette



- Stainless steel entry door knob □ 62 x 30 mm on rose □ 62,5 mm
- Satin finish
- Single sided bolt-thru fixing or on rose

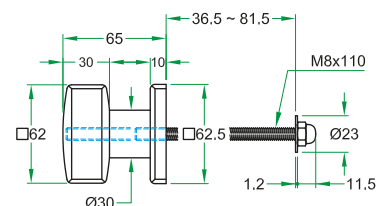

93426

Orion



- RVS 316 mat geborsteld
- Briefplaat
- Geveerd
- Buitenmaat 350 mm x 73 mm
- Opening 275 mm x 40 mm



- Inox 316 mat brossé
- Plaque de lettre
- Avec ressort
- Dimension extérieur 350 mm x 73 mm
- Ouverture 275 mm x 40 mm



- Edelstahl 316 matt gebürstet
- Briefeinwurf
- Mit Feder
- Außenabmessung 350 mm x 73 mm
- Öffnung 275 mm x 40 mm



- Stainless steel 316 satin finish
- Letterplate
- With spring
- Exterior dimension 350 mm x 73 mm
- Slot dimension 275 mm x 40 mm

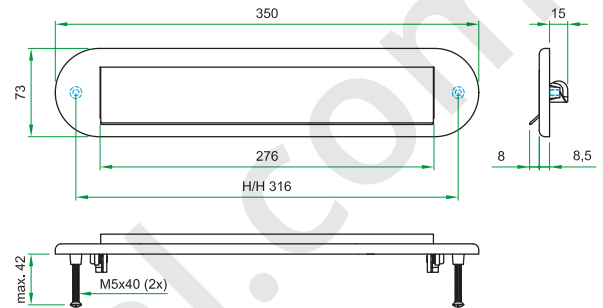

93301

Quadra



- RVS 316 mat geborsteld
- Briefplaat
- Geveerd
- Buitenmaat 350 mm x 73 mm
- Opening 275 mm x 40 mm



- Inox 316 mat brossé
- Plaque de lettre
- Avec ressort
- Dimension extérieur 350 mm x 73 mm
- Ouverture 275 mm x 40 mm



- Edelstahl 316 matt gebürstet
- Briefeinwurf
- Mit Feder
- Außenabmessung 350 mm x 73 mm
- Öffnung 275 mm x 40 mm



- Stainless steel 316 satin finish
- Letterplate
- With spring
- Exterior dimension 350 mm x 73 mm
- Slot dimension 275 mm x 40 mm

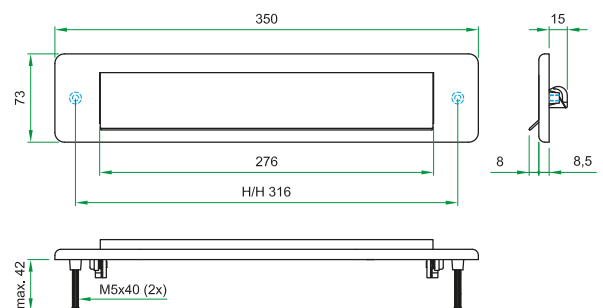

93303

Voordeur / Porte d'entrée / Haustür / Entry door



- RVS mat geborsteld
- Tochtplaat t.b.v. binnenzijde van de deur
- Afmeting 329 mm x 80 mm



- Inox mat brossé
- Courant d'air pour l'intérieur de la porte
- Dimension 329 mm x 80 mm



- Edelstahl matt gebürstet
- Zugklappe für Innenseite der Tür
- Abmessung 329 mm x 80 mm



- Stainless steel satin finish
- Draught caddy
- Dimension 329 mm x 80 mm

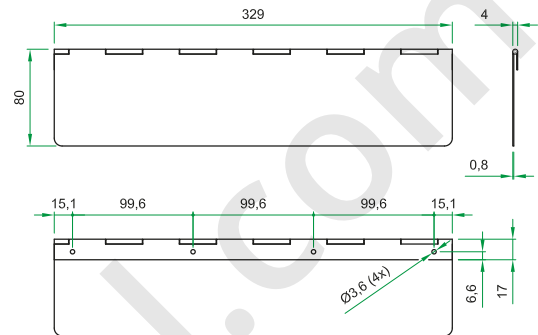

93304



- Brievenbus schacht
- RVS



- Arbre de boîte aux lettres
- Inox



- Briefeinfurfschaft
- Edelstahl



- Letterplate shaft
- Stainless steel

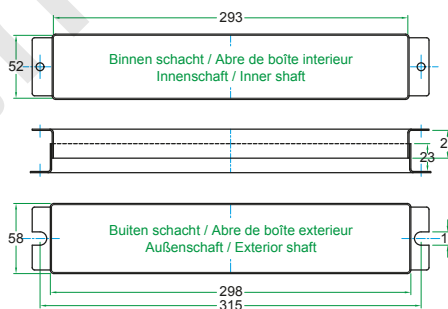
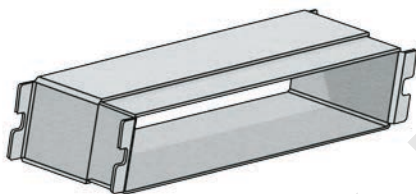

94910

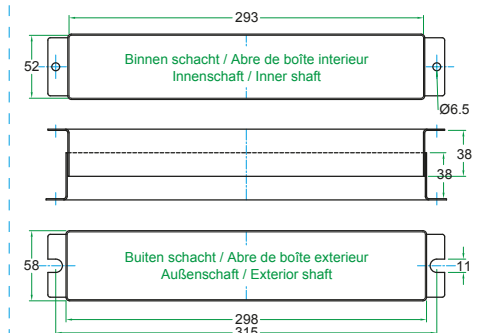

94911

24-40 mm

94910

40-76 mm

94911

Voordeur / Porte d'entrée / Haustür / Entry door

4J



93566



- Ronde beldrukker incl. belmechanisme
- RVS mat geborsteld



- Sonnette rond, y compris mécanisme de sonnette
- Inox mat brossé



- Runde Klingelplatte einschl. Klingelmechanismus
- Edelstahl matt gebürstet



- Round bell push incl. bell mechanism
- Satin stainless steel

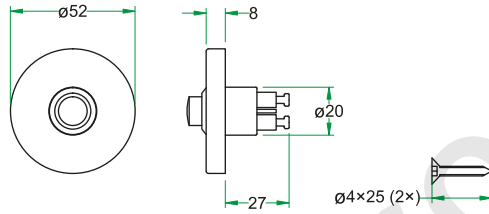

- Ovale beldrukker incl. belmechanisme
- RVS mat geborsteld



- Sonnette oval, y compris mécanisme de sonnette
- Inox mat brossé



- Ovale Klingelplatte einschl. Klingelmechanismus
- Edelstahl matt gebürstet



- Oval bell push incl. bell mechanism
- Satin stainless steel



93567

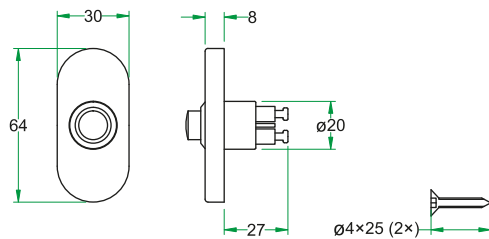

Voordeur / Porte d'entrée / Haustür / Entry door



- Huisnummers
- RVS mat geborsteld
- Onzichtbare schroefbevestiging



- Chiffres de la maison
- Inox mat brossé
- Fixation invisible



- Hausnummer
- Edelstahl matt gebürstet
- Verdeckter Schraubenbefestigung



- House numbers
- Satin stainless steel
- Invisible mounting

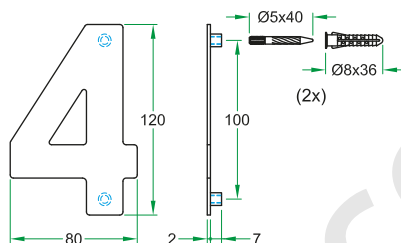

0	93020
1	93021
2	93022

3	93023
4	93024
5	93025

6 / 9	93026
7	93027
8	93028



- Huisletters
- RVS mat geborsteld
- Onzichtbare schroefbevestiging



- Lettres de la maison
- Inox mat brossé
- Fixation invisible



- Buchstaben
- Edelstahl matt gebürstet
- Verdeckter Schraubenbefestigung



- House letters
- Satin stainless steel
- Invisible mounting

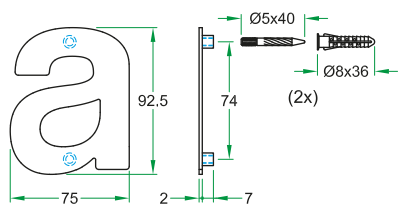

a	93029
b	93030
c	93031
d	93032

KeyGlow

4L

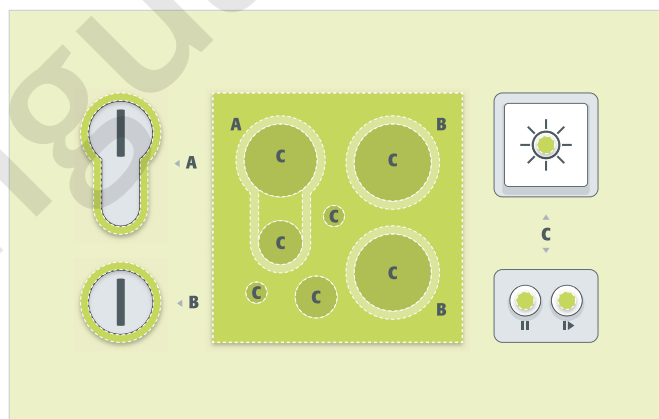
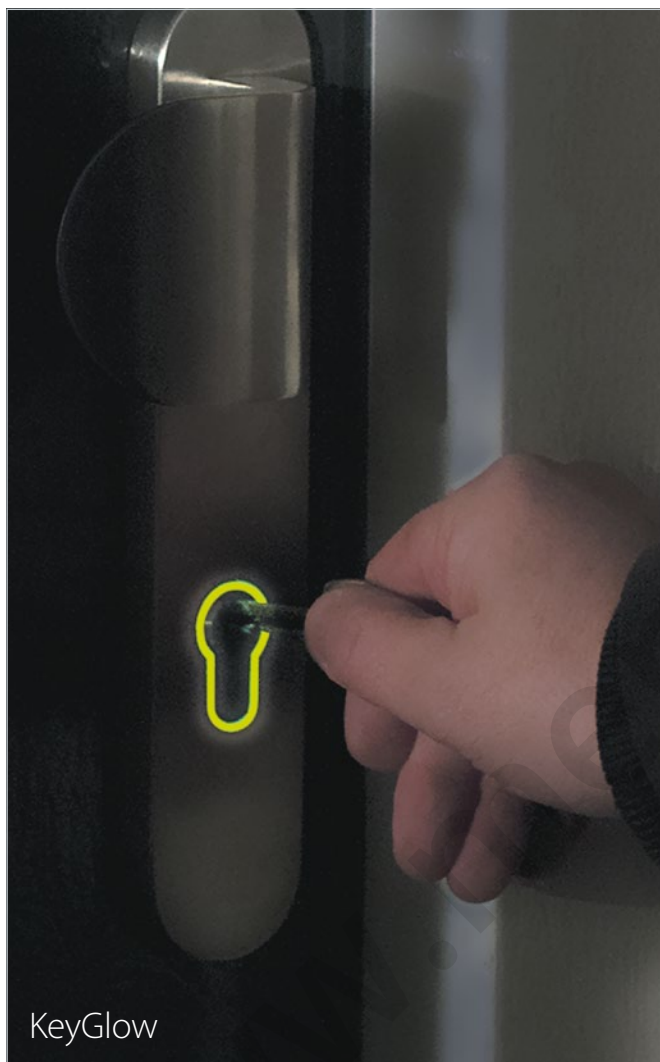

93569

93569 • 40 stuks / 40 pièces / 40 Stück / 40 pieces



- 3^e generatie glow = langste duur & 100% veilig
- De hele nacht, elke nacht weer
- Voor PC en beslag met kerntrekbeveiliging
- Inclusief stickers voor andere toepassingen



- 3^e génération lumineux = le plus long & 100% sécurisée
- Toute la nuit, chaque nuit
- Pour PC et trous de serrure avec protection de cylindre
- Inclusivement étiquettes pour d'autres applications



- 3^e Generation = längste Dauer & 100% sicher
- Leuchtet ganze Nacht, jede Nacht wieder
- Für PZ Lochung und Beschläge mit Kernziehschutz
- Etiketten für andere Anwendungen mitgebracht



- 3rd generation glow = longest glow & 100% safe
- Glows all night, every night again
- For PC- and cylinder with protection
- Includes stickers for other applications

 Algemeen

 General

 Allgemein

 General



  Deurgrepen

  Tirants

 Stoßgriffe

 Pull Handles



Deurgrepen / Tirants

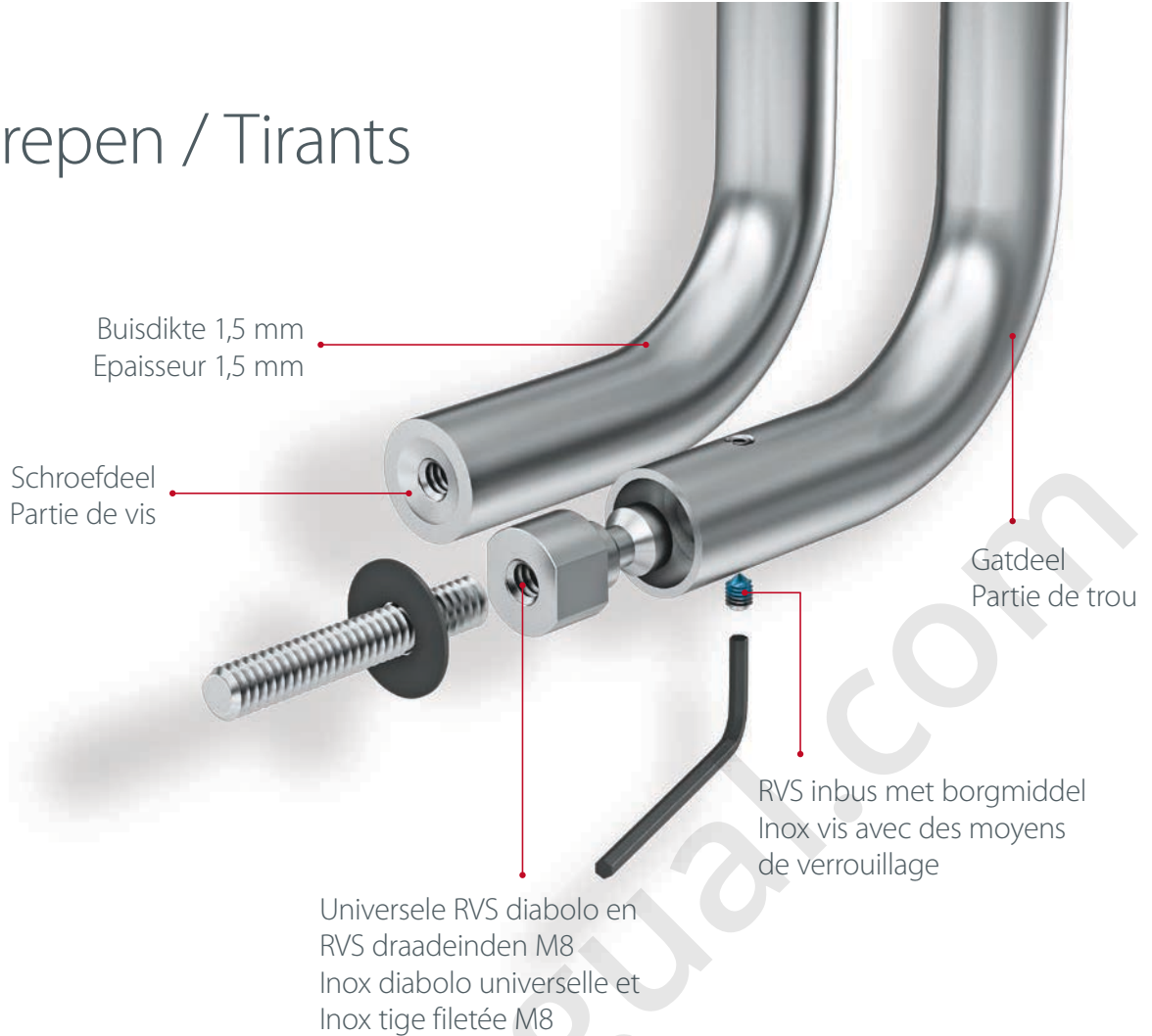

5A



KENMERKEN

- 10 jaar garantie
- RVS buisdikte 1,5 mm
- RVS, afwerking mat geborsteld
- Snelle montage basis schroef-gatdeel deurgrepen
- Universele RVS draadeinden M8
- RVS inbus met borgmiddel
- RVS bevestigingsmateriaal
- Universele RVS diabolo M8 voor alle buisdiameters en deurgrepen
- Bevestigingssets (kit) standaard geleverd met meerdere afgestemde draadeinden geschikt voor deurdikte 7-97 mm
- Prijs op aanvraag voor grepen in ral kleuren en inox gepolijst
- Mogelijkheid om platen achter de grepen te kunnen laten maken



FONCTIONS

- 10 ans de garantie
- Epaisseur de tube 1,5 mm
- Standard Inox finition mat brosse
- Montage rapide avec partie de vis et partie de trou standard
- Inox tige filetée universelle M8
- Inox vis avec des moyens de verrouillage
- Tout le matériel de fixation est en Inox
- Inox diabolo universel M8 pour tout diamètre de tube et poignées de tirants
- Sets de fixation livrés avec plusieurs tige filetées adaptées aux épaisseurs de portes 7-97 mm
- Certains modèles et mesures en Inox poli

Stoßgriffe / Pull Handles

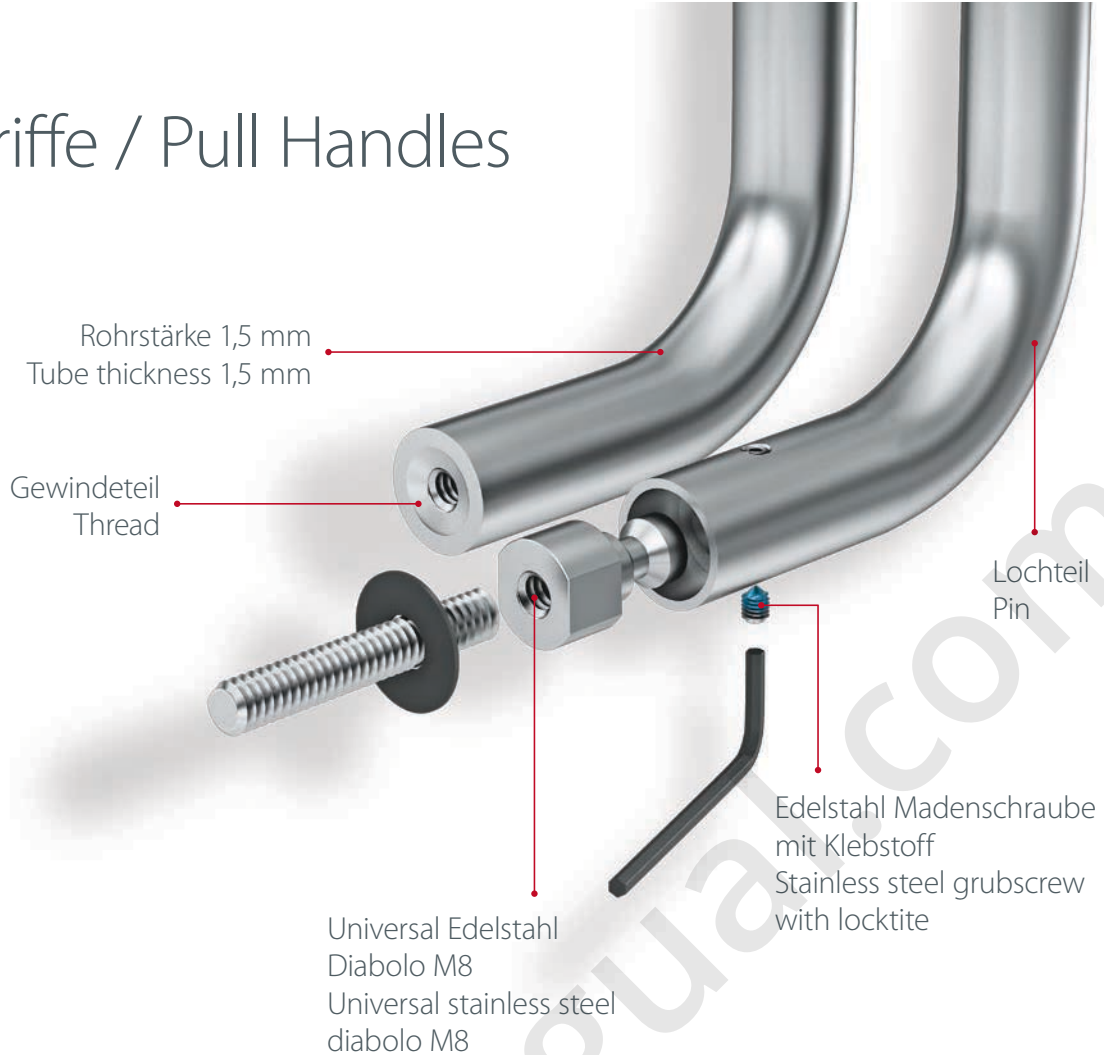

5A



EIGENSCHAFTEN

- 10 Jahre Garantie
- Edelstahl Rohrstärke 1,5 mm
- Edelstahl matt gebürstet
- Schnelle Montage auf Basis Gewindeteil+Lochteil Stoßgriffsystem
- Universal Edelstahl Gewinde M8
- Edelstahl Madenschraube mit Klebstoff
- Edelstahl Befestigung
- Universal Edelstahl Diabolo M8 für alle Durchmesser und Stoßgriffe
- Montagesatz für Turstärkebereich 7-97 mmn



FEATURES

- 10 year warranty
- Stainless steel tube thickness 1,5 mm
- Stainless steel satin
- Rapid fixing with thread/pin system
- Stainless steel M8 threads
- Grubscrews with locktite
- Fixingsets full stainless steel
- Door thickness 7-97 mm

5A



PH30 344



PH31 345



PH50 346



PH54 347



PH55 348



PH60 349



PH61 350



PH62 351



PH63 352



PH64 353



PH65 354



PH66 355



PH70 356



PH85 357



PH90 358

PH30

Deurgrepen / Tirants / Stoßgriffe / Pull handles

10
GUARANTEE



- Maatwerk mogelijk
- RVS mat geborsteld
- Buisdikte 1,5 mm
- Universeel M8 RVS bevestigingssysteem
- Doorgaande, enkelzijdige en paarsgewijze bevestiging



- Possible pour mesure spéciales
- Inox mat brossée
- Epaisseur de tube 1,5 mm
- Universelle M8 fixation inox
- Montage de la porte traversant ou non-traversant



- Sonderlängen möglich
- Edelstahl matt gebürstet
- Rohrstärke 1,5 mm
- Universal M8 Befestigungssystem aus Edelstahl
- Paarweise-, Einseitige- und durchgehende Befestigung



- Custom lengths possible
- Satin stainless steel
- Tube thickness 1,5 mm
- Universal M8 stainless steel fixing
- Pairwise-, single- and bolt-thru fixing

5A

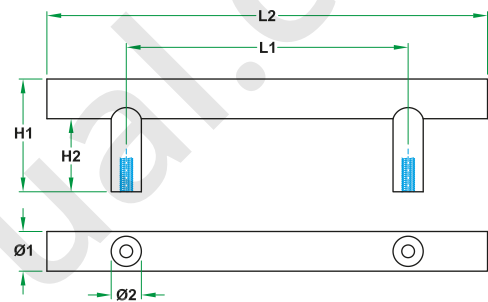

Ø	L1	L2	H1	
32	*		78	7-97

Voor meer informatie: vraag naar onze separate deurgrepencatalogus.

Pour plus d'informations informez notre catalogue de poignées.

Für weitere Informationen fordern Sie unseren separaten Stoßgriffe Katalog.

For more information ask for our separate catalog Pullhandles.

* Maatwerk / Mesure à commande / Sonder Verarbeitung / Made to order

PH31

Deurgrepen / Tirants / Stoßgriffe / Pull handles

10
GUARANTEE



- RVS mat geborsteld
- Buisdikte 1,5 mm
- Universeel M8 RVS bevestigingssysteem
- Doorgaande en enkelzijdige bevestiging



- Inox mat brossée
- Epaisseur de tube 1,5 mm
- Universelle M8 fixation inox
- Montage de la porte traversant ou non-traversant



- Edelstahl matt gebürstet
- Rohrstärke 1,5 mm
- Universal M8 Befestigungssystem aus Edelstahl
- Einseitige- und durchgehende Befestigung



- Satin stainless steel
- Tube thickness 1,5 mm
- Universal M8 stainless steel fixing
- Pairwise and single fixing

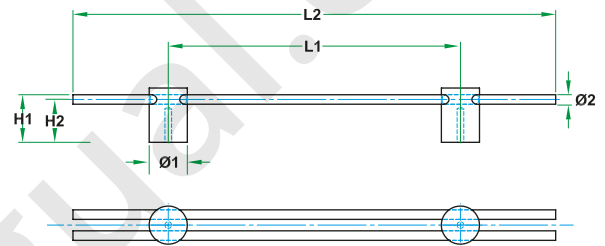

Ø	L1	L2	H1	
40	300	500	57	7-97
40	500	700	57	7-97

Voor meer informatie: vraag naar onze separate deurgrepencatalogus.

Pour plus d'informations informez notre catalogue de poignées.

Für weitere Informationen fordern Sie unseren separaten Stoßgriffe Katalog.

For more information ask for our separate catalog Pullhandles.

5A

PH50

Deurgrepen / Tirants / Stoßgriffe / Pull handles

10
GUARANTEE



- Maatwerk mogelijk
- RVS mat geborsteld
- Buisdikte 1,5 mm
- Universeel M8 RVS bevestigingssysteem
- Doorgaande, enkelzijdige en paarsgewijze bevestiging



- Possible pour mesure spéciales
- Inox mat brossée
- Epaisseur de tube 1,5 mm
- Universelle M8 fixation inox
- Montage de la porte traversant ou non-traversant



- Sonderlängen möglich
- Edelstahl matt gebürstet
- Rohrstärke 1,5 mm
- Universal M8 Befestigungssystem aus Edelstahl
- Paarweise- und Einseitige Befestigung



- Custom lengths possible
- Satin stainless steel
- Tube thickness 1,5 mm
- Universal M8 stainless steel fixing
- Pairwise- and single fixing

5A

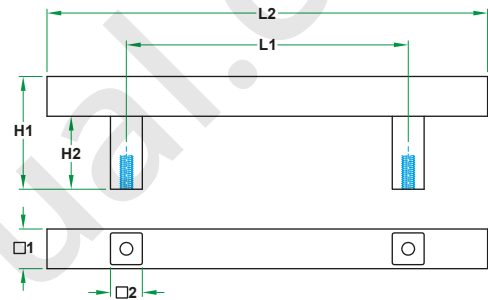

□	L1	L2	H1	
22 **	200	300	66	7-20
25	300	450	71	7-20
25	450	600	71	7-20
30	*		71	7-20
40	*		71	7-20

Voor meer informatie: vraag naar onze separate deurgrepen catalogus.

Pour plus d'informations informez notre catalogue de poignées.

Für weitere Informationen fordern Sie unseren separaten Stoßgriffe Katalog.

For more information ask for our separate catalog Pullhandles.

* Maatwerk / Mesure à commande / Sonder Verarbeitung / Made to order

** Alleen paarsgewijze bevestiging / Fixation seulement par paire
Nur Paarweise Befestigung / Only pairwise fixing

PH54

Deurgrepen / Tirants / Stoßgriffe / Pull handles

10
GUARANTÉE



- Maatwerk mogelijk
- RVS mat geborsteld
- Buisdikte 1,5 mm
- Universeel M8 RVS bevestigingssysteem
- Doorgaande, enkelzijdige en paarsgewijze bevestiging



- Possible pour mesure spéciales
- Inox mat brossée
- Epaisseur de tube 1,5 mm
- Universelle M8 fixation inox
- Montage de la porte traversant ou non-traversant



- Sonderlängen möglich
- Edelstahl matt gebürstet
- Rohrstärke 1,5 mm
- Universal M8 Befestigungssystem aus Edelstahl
- Paarweise-, Einseitige- und durchgehende Befestigung



- Custom lengths possible
- Satin stainless steel
- Tube thickness 1,5 mm
- Universal M8 stainless steel fixing
- Pairwise-, single- and bolt-thru fixing

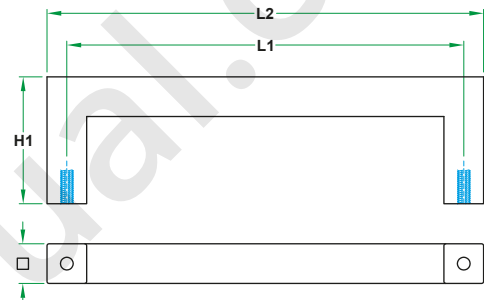

□	L1	L2	H1	
20	300	320	65	7-20
25	300	325	72	7-20
25	450	475	72	7-20
30	300	330	83	27-72
40	*		95	27-72

Voor meer informatie: vraag naar onze separate deurgrepencatalogus.

Pour plus d'informations informez notre catalogue de poignées.

Für weitere Informationen fordern Sie unseren separaten Stoßgriffe Katalog.

For more information ask for our separate catalog Pullhandles.

* Maatwerk / Mesure à commande / Sonder Verarbeitung / Made to order

PH55

Deurgrepen / Tirants / Stoßgriffe / Pull handles

10
GUARANTEE



- Maatwerk mogelijk
- RVS mat geborsteld
- Buisdikte 1,5 mm
- Universeel M8 RVS bevestigingssysteem
- Doorgaande enkelzijdige bevestiging



- Possible pour mesure spéciales
- Inox mat brossée
- Epaisseur de tube 1,5 mm
- Universelle M8 fixation inox
- Montage de la porte traversant



- Sonderlängen möglich
- Edelstahl matt gebürstet
- Rohrstärke 1,5 mm
- Universal M8 Befestigungssystem aus Edelstahl
- Einseitige durchgehende Befestigung



- Custom lengths possible
- Satin stainless steel
- Tube thickness 1,5 mm
- Universal M8 stainless steel fixing
- Single bolt-thru fixing

5A

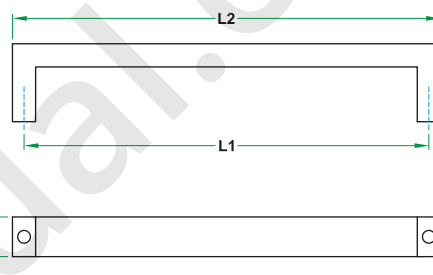

	L1	L2	H1	
50 x 20	*		70	7-97

Voor meer informatie: vraag naar onze separate deurgrepen catalogus.

Pour plus d'informations informez notre catalogue de poignées.

Für weitere Informationen fordern Sie unseren separaten Stoßgriffe Katalog.

For more information ask for our separate catalog Pullhandles.

* Maatwerk / Mesure à commande / Sonder Verarbeitung / Made to order

PH60

Deurgrepen / Tirants / Stoßgriffe / Pull handles

10
GARANTIE



- Maatwerk mogelijk
- RVS mat geborsteld
- Buisdikte 1,5 mm
- Universeel M8 RVS bevestigingssysteem
- Doorgaande, enkelzijdige en paarsgewijze bevestiging



- Possible pour mesure spéciales
- Inox mat brossée
- Epaisseur de tube 1,5 mm
- Universelle M8 fixation inox
- Montage de la porte traversant ou non-traversant



- Sonderlängen möglich
- Edelstahl matt gebürstet
- Rohrstärke 1,5 mm
- Universal M8 Befestigungssystem aus Edelstahl
- Paarweise-, Einseitige- und durchgehende Befestigung



- Custom lengths possible
- Satin stainless steel
- Tube thickness 1,5 mm
- Universal M8 stainless steel fixing
- Pairwise-, single- and bolt-thru fixing

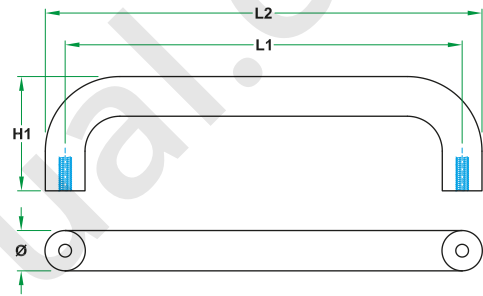

Ø	L1	H1	
19	125	65	7-20
19	200	65	7-20
19	300	65	7-20
25	300	72	7-97
25	650	72	7-97
32	300	83	7-97
32	350	83	7-97
32	400	83	7-97
38	*	95	7-97

Voor meer informatie: vraag naar onze separate deurgrepencatalogus.

Pour plus d'informations informez notre catalogue de poignées.

Für weitere Informationen fordern Sie unseren separaten Stoßgriffe Katalog.

For more information ask for our separate catalog Pullhandles.

* Maatwerk / Mesure à commande / Sonder Verarbeitung / Made to order

PH61

Deurgrepen / Tirants / Stoßgriffe / Pull handles

10
GUARANTEE



- Maatwerk mogelijk
- RVS mat geborsteld
- Buisdikte 1,5 mm
- Universeel M8 RVS bevestigingssysteem
- Doorgaande, enkelzijdige en paarsgewijze bevestiging



- Possible pour mesure spéciales
- Inox mat brossée
- Epaisseur de tube 1,5 mm
- Universelle M8 fixation inox
- Montage de la porte traversant ou non-traversant





- Sonderlängen möglich
- Edelstahl matt gebürstet
- Rohrstärke 1,5 mm
- Universal M8 Befestigungssystem aus Edelstahl
- Paarweise-, Einseitige- und durchgehende Befestigung

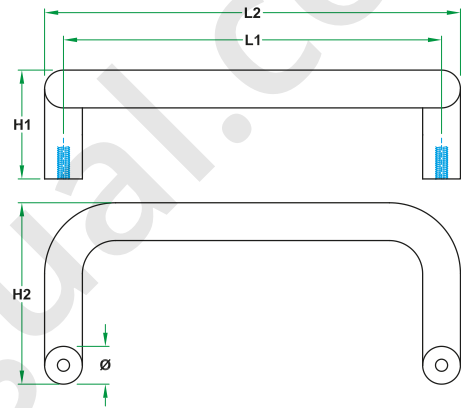

- Custom lengths possible
- Satin stainless steel
- Tube thickness 1,5 mm
- Universal M8 stainless steel fixing
- Pairwise-, single- and bolt-thru fixing

5A



Ø	L1	H1	H2	
25	300	72	120	7-97
32	300	83	120	7-97
32	350	83	120	7-97
32	650	83	120	7-97

Voor meer informatie: vraag naar onze separate deurgrepencatalogus.

Pour plus d'informations informez notre catalogue de poignées.

Für weitere Informationen fordern Sie unseren separaten Stoßgriffe Katalog.

For more information ask for our separate catalog Pullhandles.

PH62

Deurgrepen / Tirants / Stoßgriffe / Pull handles

10
GUARANTEE



- RVS mat geborsteld
- Buisdikte 1,5 mm
- Universeel M8 RVS bevestigingssysteem
- Doorgaande, enkelzijdige en paarsgewijze bevestiging



- Inox mat brossée
- Epaisseur de tube 1,5 mm
- Universelle M8 fixation inox
- Montage de la porte traversant ou non-traversant



- Edelstahl matt gebürstet
- Rohrstärke 1,5 mm
- Universal M8 Befestigungssystem aus Edelstahl
- Paarweise-, Einseitige- und durchgehende Befestigung



- Satin stainless steel
- Tube thickness 1,5 mm
- Universal M8 stainless steel fixing
- Pairwise-, single- and bolt-thru fixing

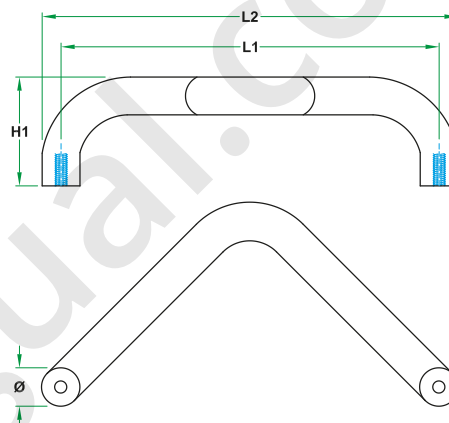

Ø	L1	H1	
32	300	83	7-97

Voor meer informatie: vraag naar onze separate deurgrepen catalogus.

Pour plus d'informations informez notre catalogue de poignées.

Für weitere Informationen fordern Sie unseren separaten Stoßgriffe Katalog.

For more information ask for our separate catalog Pullhandles.

5A

PH63

Deurgrepen / Tirants / Stoßgriffe / Pull handles

10
GUARANTEE



- RVS mat geborsteld
- Buisdikte 1,5 mm
- Universeel M8 RVS bevestigingssysteem
- Doorgaande, enkelzijdige en paarsgewijze bevestiging



- Inox mat brossée
- Epaisseur de tube 1,5 mm
- Universelle M8 fixation inox
- Montage de la porte traversant ou non-traversant



- Edelstahl matt gebürstet
- Rohrstärke 1,5 mm
- Universal M8 Befestigungssystem aus Edelstahl
- Paarweise-, Einseitige- und durchgehende Befestigung



- Satin stainless steel
- Tube thickness 1,5 mm
- Universal M8 stainless steel fixing
- Pairwise-, single- and bolt-thru fixing

5A

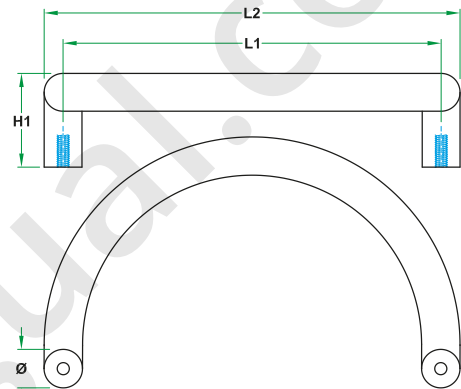

Ø	L1	H1	
32	300	83	7-97

Voor meer informatie: vraag naar onze separate deurgrepencatalogus.

Pour plus d'informations informez notre catalogue de poignées.

Für weitere Informationen fordern Sie unseren separaten Stoßgriffe Katalog.

For more information ask for our separate catalog Pullhandles.

PH64

Deurgrepen / Tirants / Stoßgriffe / Pull handles

10
GUARANTEE



- Maatwerk mogelijk
- RVS mat geborsteld
- Buisdikte 1,5 mm
- Universeel M8 RVS bevestigingssysteem
- Doorgaande, enkelzijdige en paarsgewijze bevestiging



- Possible pour mesure spéciales
- Inox mat brossée
- Epaisseur de tube 1,5 mm
- Universelle M8 fixation inox
- Montage de la porte traversant ou non-traversant



- Sonderlängen möglich
- Edelstahl matt gebürstet
- Rohrstärke 1,5 mm
- Universal M8 Befestigungssystem aus Edelstahl
- Paarweise-, Einseitige- und durchgehende Befestigung



- Custom lengths possible
- Satin stainless steel
- Tube thickness 1,5 mm
- Universal M8 stainless steel fixing
- Pairwise-, single- and bolt-thru fixing

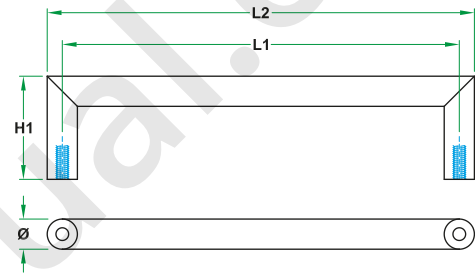

Ø	L1	H1	
19	300	65	7-20
32	300	83	7-92
25	*	72	7-92
38	*	95	7-97

Voor meer informatie: vraag naar onze separate deurgrepencatalogus.

Pour plus d'informations informez notre catalogue de poignées.

Für weitere Informationen fordern Sie unseren separaten Stoßgriffe Katalog.

For more information ask for our separate catalog Pullhandles.

* Maatwerk / Mesure à commande / Sonder Verarbeitung / Made to order

PH65

Deurgrepen / Tirants / Stoßgriffe / Pull handles

10
GUARANTEE



- RVS mat geborsteld
- Buisdikte 1,5 mm
- Universeel M8 RVS bevestigingssysteem
- Doorgaande enkelzijdige bevestiging



- Inox mat brossée
- Epaisseur de tube 1,5 mm
- Universelle M8 fixation inox
- Montage de la porte traversant





- Edelstahl matt gebürstet
- Rohrstärke 1,5 mm
- Universal M8 Befestigungssystem aus Edelstahl
- Einseitige durchgehende Befestigung

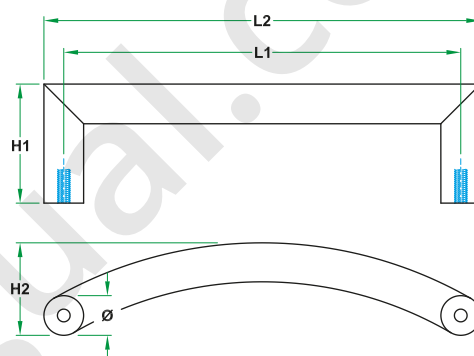

- Satin stainless steel
- Tube thickness 1,5 mm
- Universal M8 stainless steel fixing
- Single bolt-thru fixing

5A



Ø	L1	H1	
32	300	83	7-97
32	500	83	7-97
32	770	83	7-97

Voor meer informatie: vraag naar onze separate deurgrepen catalogus.

Pour plus d'informations informez notre catalogue de poignées.

Für weitere Informationen fordern Sie unseren separaten Stoßgriffe Katalog.

For more information ask for our separate catalog Pullhandles.

PH66

Deurgrepen / Tirants / Stoßgriffe / Pull handles

10
GUARANTEE



- RVS mat geborsteld
- Buisdikte 1,5 mm
- Universeel M8 RVS bevestigingssysteem
- Doorgaande enkelzijdige bevestiging



- Inox mat brossée
- Epaisseur de tube 1,5 mm
- Universelle M8 fixation inox
- Montage de la porte traversant



- Edelstahl matt gebürstet
- Rohrstärke 1,5 mm
- Universal M8 Befestigungssystem aus Edelstahl
- Einseitige durchgehende Befestigung



- Satin stainless steel
- Tube thickness 1,5 mm
- Universal M8 stainless steel fixing
- Single bolt-thru fixing

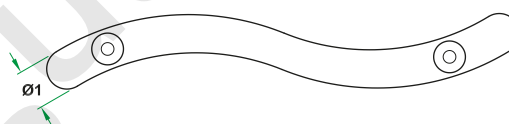

Ø	L1	L2	H1	
25	350	450	71	27-72

Voor meer informatie: vraag naar onze separate deurgrepencatalogus.

Pour plus d'informations informez notre catalogue de poignées.

Für weitere Informationen fordern Sie unseren separaten Stoßgriffe Katalog.

For more information ask for our separate catalog Pullhandles.

5A

PH70

Deurgrepen / Tirants / Stoßgriffe / Pull handles

10
GUARANTEE



- Maatwerk mogelijk
- RVS mat geborsteld
- Buisdikte 1,5 mm
- Universeel M8 RVS bevestigingssysteem
- Doorgaande, enkelzijdige en paarsgewijze bevestiging



- Possible pour mesure spéciales
- Inox mat brossée
- Epaisseur de tube 1,5 mm
- Universelle M8 fixation inox
- Montage de la porte traversant ou non-traversant



- Sonderlängen möglich
- Edelstahl matt gebürstet
- Rohrstärke 1,5 mm
- Universal M8 Befestigungssystem aus Edelstahl
- Paarweise-, Einseitige- und durchgehende Befestigung



- Custom lengths possible
- Satin stainless steel
- Tube thickness 1,5 mm
- Universal M8 stainless steel fixing
- Pairwise-, single- and bolt-thru fixing

5A

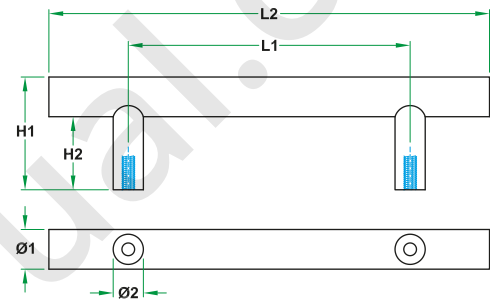

Ø	L1	L2	H1	H2	
19	200	300	65	41	7-20
19	300	400	65	41	7-20
19	300	500	65	41	7-20
19	340	500	65	41	7-20
19	500	700	65	41	7-20
19	540	700	65	41	7-20
19	600	800	65	41	7-97
19	1000	1200	65	41	7-97
25	200	300	71	41	7-97
25	300	500	71	41	7-97
25	500	700	71	41	7-97
25	600	800	71	41	7-97
32	200	300	78	41	7-97
32	500	700	78	41	7-97
32	800	1000	78	41	7-97
32	1000	1200	78	41	7-97
38	*	*	84	41	7-97

Voor meer informatie: vraag naar onze separate deurgrepencatalogus.

Pour plus d'informations informez notre catalogue de poignées.

Für weitere Informationen fordern Sie unseren separaten Stoßgriffe Katalog.

For more information ask for our separate catalog Pullhandles.

* Maatwerk / Mesure à commande / Sonder Verarbeitung / Made to order

PH85

Deurgrepen / Tirants / Stoßgriffe / Pull handles

10
GUARANTEE



- Maatwerk mogelijk
- RVS mat geborsteld
- Buisdikte 1,5 mm
- Universeel M8 RVS bevestigingssysteem
- Doorgaande, enkelzijdige en paarsgewijze bevestiging



- Possible pour mesure spéciales
- Inox mat brossée
- Epaisseur de tube 1,5 mm
- Universelle M8 fixation inox
- Montage de la porte traversant ou non-traversant



- Sonderlängen möglich
- Edelstahl matt gebürstet
- Rohrstärke 1,5 mm
- Universal M8 Befestigungssystem aus Edelstahl
- Paarweise-, Einseitige- und durchgehende Befestigung



- Custom lengths possible
- Satin stainless steel
- Tube thickness 1,5 mm
- Universal M8 stainless steel fixing
- Pairwise-, single- and bolt-thru fixing

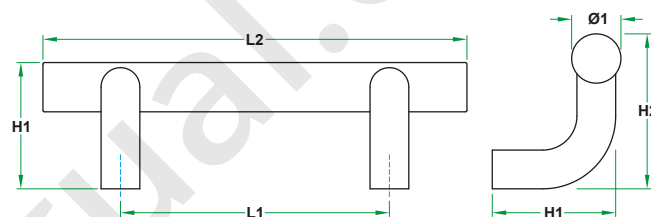

Ø	L1	L2	H1	H2	
32	300	500	81,5	100	27-72

Voor meer informatie: vraag naar onze separate deurgrepencatalogus.

Pour plus d'informations informez notre catalogue de poignées.

Für weitere Informationen fordern Sie unseren separaten Stoßgriffe Katalog.

For more information ask for our separate catalog Pullhandles.

5A

PH90

Deurgrepen / Tirants / Stoßgriffe / Pull handles

10
GUARANTEE



- **Maatwerk mogelijk**
- RVS mat geborsteld
- Buisdikte 1,5 mm
- Universeel M8 RVS bevestigingssysteem
- Doorgaande, enkelzijdige en paarsgewijze bevestiging



- **Possible pour mesure spéciales**
- Inox mat brossée
- Epaisseur de tube 1,5 mm
- Universelle M8 fixation inox
- Montage de la porte traversant ou non-traversant



- **Sonderlängen möglich**
- Edelstahl matt gebürstet
- Rohrstärke 1,5 mm
- Universal M8 Befestigungssystem aus Edelstahl
- Paarweise-, Einseitige- und durchgehende Befestigung



- **Custom lengths possible**
- Satin stainless steel
- Tube thickness 1,5 mm
- Universal M8 stainless steel fixing
- Pairwise-, single- and bolt-thru fixing

5A

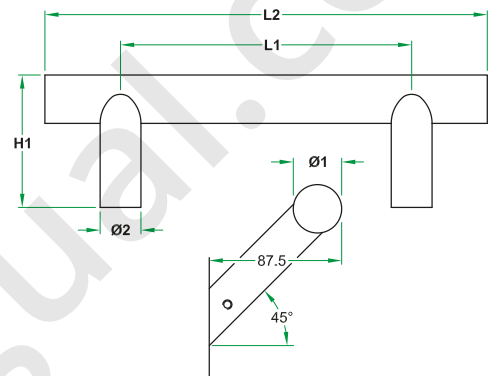

Ø	L1	L2	H1	
25	300	500	87,5	35-103
25	500	700	87,5	35-103
32	300	500	87,5	35-103
32	400	600	87,5	35-103
32	500	700	87,5	35-103
32	600	800	87,5	35-103
32	800	1000	87,5	35-103
32	1000	1200	87,5	35-103

Voor meer informatie: vraag naar onze separate deurgrepencatalogus.

Pour plus d'informations informez notre catalogue de poignées.

Für weitere Informationen fordern Sie unseren separaten Stoßgriffe Katalog.





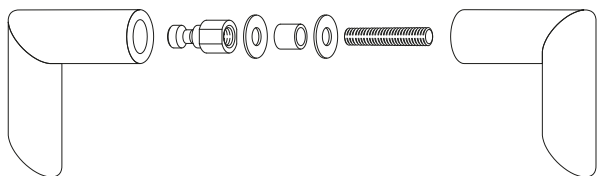

For more information ask for our separate catalog Pullhandles.

BEVESTIGING • FIXATION • BEFESTIGUNG • MOUNTING

Deurgrepen / Tirants / Stoßgriffe / Pull handles







01/02/03/04/05

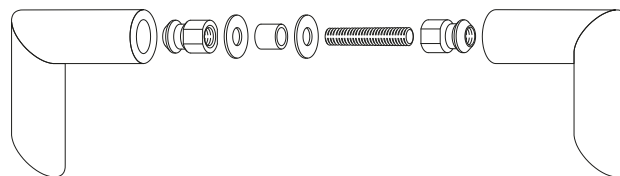

-   Paarsgewijs - doorgaand (schroefdeel+ gatdeel)
-   Traversante à la paire (partie de vis / de trou)
-  Paarweise - durchgehend (Gewindeteil+Lochteil)
-  Back to back - bolt through (thread + pin)







06

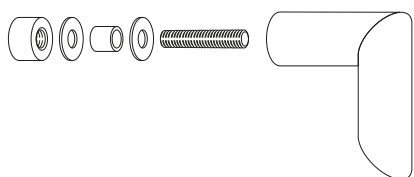

-   Paarsgewijs - doorgaand (gatdeel + gatdeel)
-   Traversante à la paire (partie de vis / de trou)
-  Paarweise - durchgehend (Lochteil+Lochteil)
-  Back to back - bolt through (pin + pin)







11/12/13/14/15/16

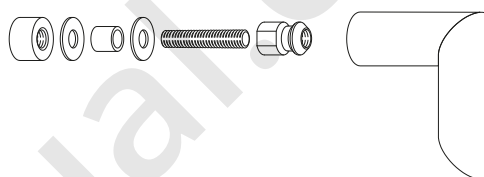

-   Enkelzijdig doorgaand (=schroefdeel) met rvs sierdop
-   Traversante avec cache décoratif (partie de vis)
-  Einseitig durchgehend (= Gewindeteil) mit ES Scheibe
-  Single sided bolt through (= thread) with endcap







17

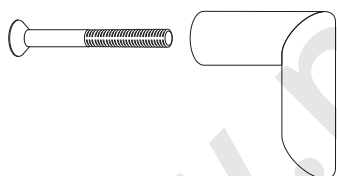

-   Enkelzijdig doorgaand (=gatdeel) met sierdop
-   Traversante avec cache décoratif (partie de trou)
-  Einseitig durchgehend (= Lochteil) mit ES Scheibe
-  Single sided bolt through (= pin) with endcap







41

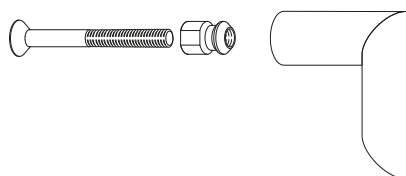

-   Enkelzijdig doorgaand (=schroefdeel) met schroefkop
-   Traversante avec cache de vis (partie de vis)
-  Einseitig durchgehend (= Gewindeteil) mit Schraubkopf
-  Single sided bolt through (= thread) with screwhead







42

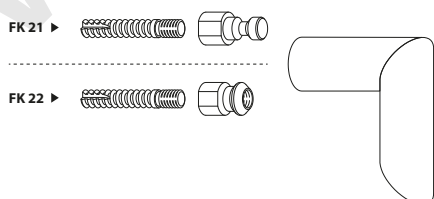

-   Enkelzijdig doorgaand (=gatdeel) met schroefkop
-   Traversante avec cache de vis (partie de trou)
-  Einseitig durchgehend (= Lochteil) mit Schraubkopf
-  Single sided bolt through (= pin) screwhead







21/22

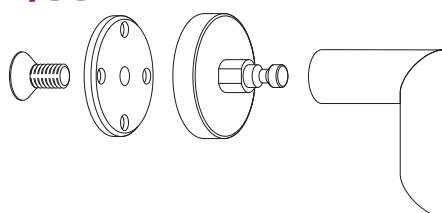

-   Enkelzijdig niet doorgaand (=gatdeel) blind
-   Non-traversante invisible (partie de trou)
-  Einseitig nicht durchgehend (= Lochteil) blind
-  Single sided fixed (= pin) blind

31/32/33



-   Enkelzijdig niet doorgaand (=gatdeel) met rozet
-   Non-traversante avec rosace (partie de trou)
-  Einseitig nicht durchgehend (= Lochteil) mit Rosette
-  Single sided fixed (= pin) on rose

5A



  Glasdeurbeslag

  Quincaillerie pour porte en verre

 Glastürbeschläge

 Glass door hardware







Frankfurt 364



München 365



Office 366



80190 367



80191 368



80001 369



80003 369



80005 370

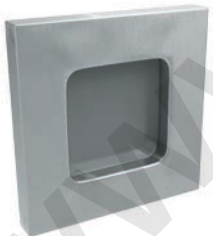

80006 371



80007 370



Star 372

Frankfurt

Glasdeurbeslag / Quincaillerie pour porte en verre / Glastürbeschläge / Glass door hardware

5B

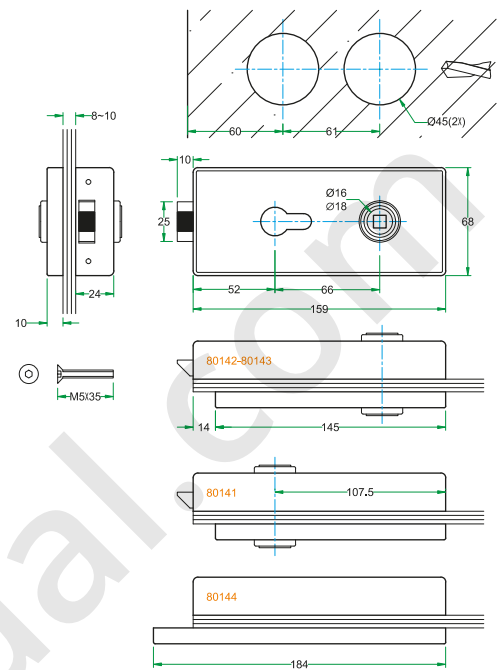

- Glasdeurslot
- Duitse kwaliteit, getest op 200.000 cycli
- 100% stiftvast, geen speling door klem in kruk gat
- Links en rechts bruikbaar
- RVS mat geborsteld



- Serrure pour porte en verre Qualité allemande testé à 200.000 cycles
- Douille de serrage qui offre une fixation à 100%
- Utilisable à droite e à gauche
- Inox mat brossé



- Glastürschloß
- Deutsche Qualität, getestet auf 200.000 Zyklen.
- 100% Halt, kein Wackeln Klemmuß
- Links und rechts verwendbar
- Edelstahl matt gebürstet



- Glass door lock
- German quality, tested on 200.000 cycles
- 100% tight, clamping nut = no tolerance
- Left and right applicable
- Satin stainless steel



	80141
	80142
	80143
	80144

München

Glasdeurbeslag / Quincaillerie pour porte en verre / Glastürbeschläge / Glass door hardware



8-10 mm

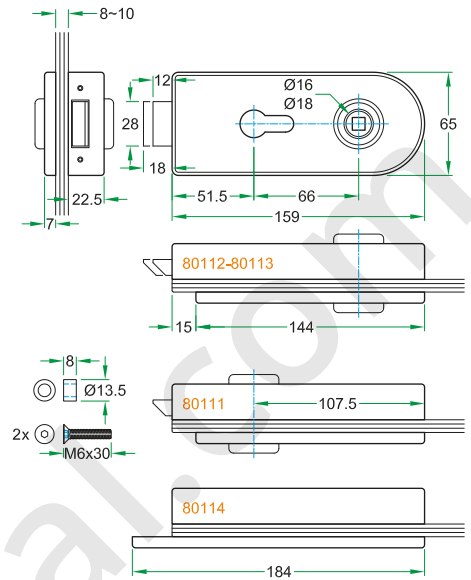

- Glasdeurslot
- Duitse kwaliteit, getest op 200.000 cycli
- 100% stiftvast, geen speling door klem in krukgat
- Links en rechts bruikbaar
- RVS mat geborsteld



- Serrure pour porte en verre Qualité allemande testé à 200.000 cycles
- Douille de serrage qui offre une fixation à 100%
- Utilisable à droite e à gauche
- Inox mat brossé



- Glastürschloß
- Deutsche Qualität, getestet auf 200.000 Zyklen.
- 100% Halt, kein Wackeln Klemmuß
- Links und rechts verwendbar
- Edelstahl matt gebürstet



- Glass door lock
- German quality, tested on 200.000 cycles
- 100% tight, clamping nut = no tolerance
- Left and right applicable
- Satin stainless steel



	80111
	80112
	80113
	80114

	10-12 mm		M6x35	93421/35
Adapter voor Proline wisselknop / Adapteur pour Proline bouton Adapter für Proline Wechselknopf / Adapter for Proline fixed knob				80107

Office

Glasdeurbeslag / Quincaillerie pour porte en verre / Glastürbeschläge / Glass door hardware

5B

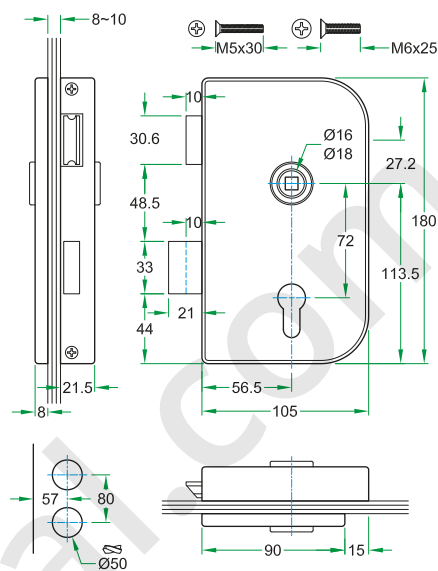

- Glasdeurslot
- Duitse kwaliteit, getest op 200.000 cycli
- 100% stiftvast, geen speling door klem in krukgat
- Links en rechts bruikbaar
- RVS mat geborsteld



- Serrure pour porte en verre Qualité allemande testé à 200.000 cycles
- Douille de serrage qui offre une fixation à 100%
- Utilisable à droite e à gauche
- Inox mat brossé



- Glastürschloß
- Deutsche Qualität, getestet auf 200.000 Zyklen.
- 100% Halt, kein Wackeln Klemmnuß
- Links und rechts verwendbar
- Edelstahl matt gebürstet



- Glass door lock
- German quality, tested on 200.000 cycles
- 100% tight, clamping nut = no tolerance
- Left and right applicable
- Satin stainless steel



	80131/L		80133/L	Adapter voor Proline wisselknop Adaptateur pour Proline bouton Adapter für Proline Wechselknopf Adapter for Proline fixed knob	80108
	80131/R		80133/R		
	80132/L		80134/L		
	80132/R		80134/R		
				93419/35	

Scharnier / Charnière / Band / Hinge

Glasdeurbeslag / Quincaillerie pour porte en verre / Glastürbeschläge / Glass door hardware

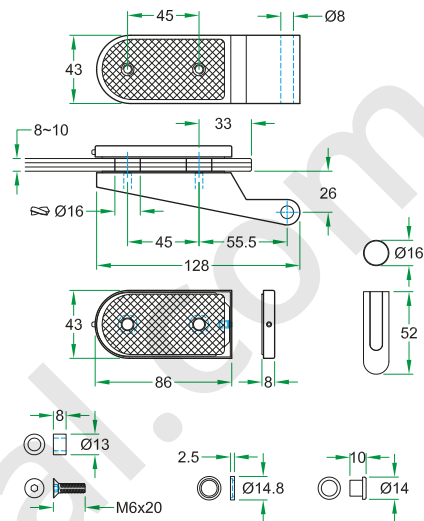

- Massief RVS 2-delig glasdeur scharnier voor slot München
- 100% stevigheid door ruwe rubber inleg
- Duitse kwaliteit
- RVS mat geborsteld



- Charnière composée de deux parties en inox massif pour serrure München
- Fixation garantie à 100% avec insertion en caoutchouc
- Qualité allemande
- Inox mat brossé



- Massiv Edelstahl 2-teiliges Band für Schloß München
- 100% Halt mit Riefengumi-Einlage
- Deutsche Qualität
- Edelstahl matt gebürstet



- Solid stainless steel 2-part hinge for lock München
- 100% support with grooved rubber insert
- Germany quality
- Satin stainless steel



80190

Scharnier / Charnière / Band / Hinge

Glasdeurbeslag / Quincaillerie pour porte en verre / Glastürbeschläge / Glass door hardware

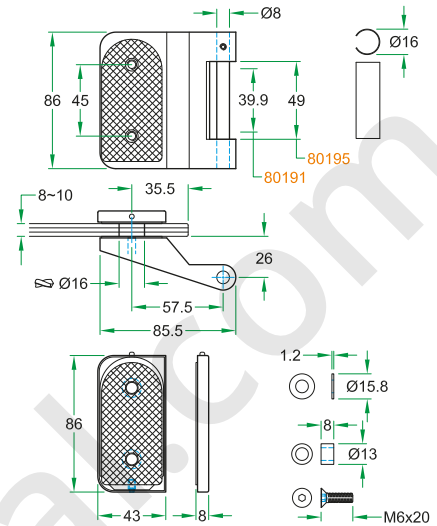

5B



- Massief RVS 3-delig glasdeur scharnier
- 100% stevigheid door ruwe rubber-inleg
- Duitse kwaliteit
- Keuze scharniermaat kozijndeel 39,9 mm of 49 mm
- RVS mat geborsteld



- Charnière composée de trois parties en inox massif
- Fixation garantie à 100% avec insertion en caoutchouc
- Qualité allemande
- Choix de la dimension du cadre charnière 39,9 mm ou 49 mm
- Inox mat brossé



- Massiv Edelstahl 3-teiliges Band
- 100% Halt mit Riefengumi-Einlage
- Deutsche Qualität
- Scharnierfensterrahmen Wahl 39,9 mm oder 49 mm
- Edelstahl matt gebürstet



- Solid stainless steel 3-part hinge
- 100% support with grooved rubber insert
- Germany quality
- Choice of hingeframe 39,9 mm or 49 mm
- Satin stainless steel



Scharniermaat kozijndeel / Cadre charnière
Scharnierfensterrahmen / Hingeframe

	39,9 mm	80191
--	---------	-------



Scharniermaat kozijndeel / Cadre charnière
Scharnierfensterrahmen / Hingeframe

	49 mm	80195
--	-------	-------

Schuifdeurkommen / Cuvettes / Schiebetürmuschel / Sliding pulls

Glasdeurbeslag / Quincaillerie pour porte en verre / Glastürbeschläge / Glass door hardware



- Massief RVS schuifdeurkom Ø 60 mm
- RVS mat geborsteld



- Cuvette en inox massif Ø 60 mm
- Inox mat brossé



- Massiv Edelstahl Glastürmuschel Ø 60 mm
- Edelstahl matt gebürstet



- Solid stainless steel glass door pull Ø 60 mm
- Satin stainless steel

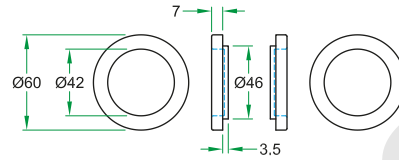

- Massief RVS schuifdeurkom Ø 60 mm
- Zelfklevend
- RVS mat geborsteld



- Cuvette en inox massif Ø 60 mm
- Intérieur adhésif
- Inox mat brossé



- Massiv Edelstahl Glastürmuschel Ø 60 mm
- Selbstklebend
- Edelstahl matt gebürstet



- Solid stainless steel glass door pull Ø 60 mm
- Self adhesive
- Satin stainless steel

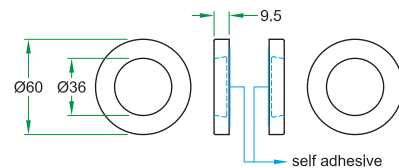

Schuifdeurkommen / Cuvettes / Schiebetürmuschel / Sliding pulls

Glasdeurbeslag / Quincaillerie pour porte en verre / Glastürbeschläge / Glass door hardware

5B



- Massief RVS schuifdeurkom Ø 60 mm
- Opschroefbaar
- RVS mat geborsteld



- Cuvette en inox massif Ø 60 mm
- A visser
- Inox mat brossé



- Massiv Edelstahl Glastürmuschel Ø 60 mm
- Zum Schrauben
- Edelstahl matt gebürstet



- Solid stainless steel glass door pull Ø 60 mm
- Screw system
- Satin stainless steel

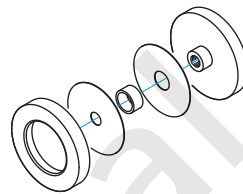
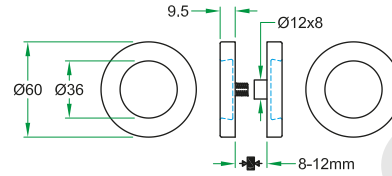

- Massief RVS schuifdeurkom Ø 65 mm
- Binnengat Ø 38 mm
- Opschroefbaar
- RVS mat geborsteld



- Cuvette en inox massif Ø 65 mm
- Trou interieur Ø 38 mm
- A visser
- Inox mat brossé



- Massiv Edelstahl Glastürmuschel Ø 65 mm
- Innenloch Ø 38 mm
- Zum Schrauben
- Edelstahl matt gebürstet



- Solid stainless steel glass door pull Ø 65 mm
- Interior hole Ø 38 mm
- Screw system
- Satin stainless steel

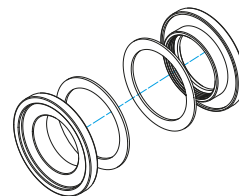
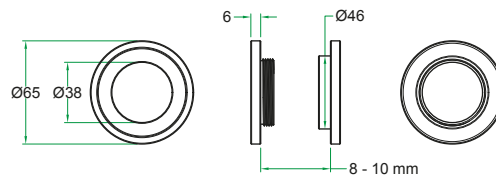

Schuifdeurkommen / Cuvettes / Schiebetürmuschel / Sliding pulls

Glasdeurbeslag / Quincaillerie pour porte en verre / Glastürbeschläge / Glass door hardware



- Massief RVS schuifdeurkom 70 x 70 mm
- Zelfklevend
- RVS mat geborsteld



- Cuvette en inox massif 70 x 70 mm
- Intérieur adhésif
- Inox mat brossé



- Massiv Edelstahl Glastürmuschel 70 x 70 mm
- Selbstklebend
- Edelstahl matt gebürstet



- Solid stainless steel glass door pull 70 x 70 mm
- Self adhesive
- Satin stainless steel

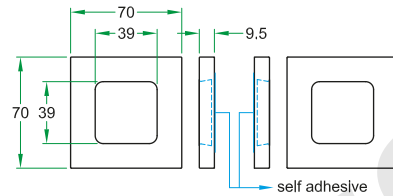

80006

Star

Glasdeurbeslag / Quincaillerie pour porte en verre / Glastürbeschläge / Glass door hardware

5B

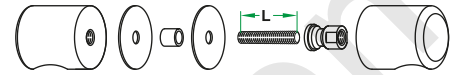
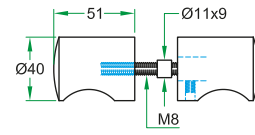

mm	L
8-26	M8x45

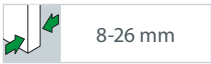

- Massief RVS glasdeurknop
- Ø 40 mm en Ø 50 mm
- Paarsgewijs doorgaand
- RVS mat geborsteld



- Bouton de porte en verre inox massif
- Ø 40 mm et Ø 50 mm
- Traversante à la paire
- Inox mat brossé



- Massiv Edelstahl Glastürknopf
- Ø 40 mm und Ø 50 mm
- Paarweise durchgehend
- Edelstahl matt gebürstet



- Solid steel steel glass door knob
- Ø 40 mm and Ø 50 mm
- Pair back-to-back fixing
- Satin stainless steel



	Ø 40 mm	93244
	Ø 50 mm	93248

COMPONENTEN / COMPOSANTS / ZUBEHÖR / COMPONENTS

Glasdeurbeslag / Quincaillerie pour porte en verre / Glastürbeschläge / Glass door hardware



80180



- Deurvastzetter, incl. sluitkom
- RVS mat geborsteld



- Caleur de porte, incl. socle
- Inox mat brossé



- Türfeststeller, einschl. Aufnahmebuchse
- Edelstahl matt gebürstet



- Doorfastener, incl. receptacle
- Satin stainless steel



80181



- Deurvastzetter, boven
- Staal, mat nikkel



- Caleur de porte, en haut
- Acier, nickel mat



- Feststellschnapper, oben
- Stahl, Nickel matt



- Doorfastener, upper
- Steel, satin nickel



- Draaiknop-cylinder
- 25/20 mm en 20/25 mm
- Mat geborsteld



- Cylindre avec bouton tournant
- 25/20 mm et 20/25 mm
- Mat brossé



- Drehknop-Zylinder
- 25/20 mm und 20/25mm
- Matt gebürstet



- Turnknob-cylinder
- 25/20 mm and 20/25 mm
- Brushed finish

25/20 mm	80183
20/25 mm	80184

COMPONENTEN / COMPOSANTS / ZUBEHÖR / COMPONENTS

Glasdeurbeslag / Quincaillerie pour porte en verre / Glastürbeschläge / Glass door hardware

5B



80187



- Aanschroefbaar scharnierdeel
- Geschikt voor 3-delig scharnier 80191
- RVS mat geborsteld



- Component charnière à visser
- Apte pour charnière en 3 parties 80191
- Inox mat brossé



- Scharnierteil zum Schrauben
- Geeignet für 3-teiliges Scharnier 80191
- Edelstahl matt gebürstet



- Hinge component
- Suitable for 3-part hinge 80191
- Satin stainless steel

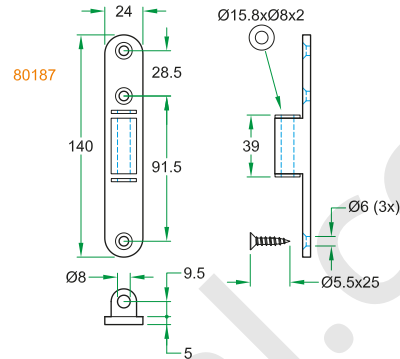

- Aanschroefbaar scharnierdeel
- Geschikt voor 2-delig scharnier 80190
- RVS mat geborsteld



- Component charnière à visser
- Apte pour charnière en 2 parties 80190
- Inox mat brossé



- Scharnierteil zum Schrauben
- Geeignet für 2-teiliges Scharnier 80190
- Edelstahl Matt gebürstet



- Hinge component
- Suitable for 2-part hinge 80190
- Satin stainless steel



80188

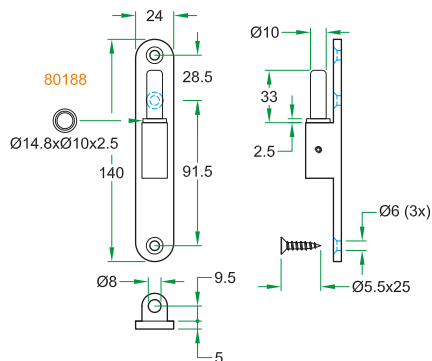

COMPONENTEN / COMPOSANTS / ZUBEHÖR / COMPONENTS

Glasdeurbeslag / Quincaillerie pour porte en verre / Glastürbeschläge / Glass door hardware



80185



- Scharnierdeel voor stalen kozijn
- Lengte 38,5 mm
- Staal verzinkt



- Component de charnière tournant pour châssis de porte en acier
- Longueur 38,5 mm
- Acier galvanisé



- Rahmenteil für Stahlzarge
- Länge 38,5 mm
- Stahl verzinkt



- Turnable hinge component for steel frame
- Length 38,5 mm
- Steel zinc plated



80186



- Staal scharnierdeel voor houten kozijn
- Lengte 38,5 mm
- Staal verzinkt



- Component de charnière tournant en acier pour châssis de porte en bois
- Longueur 38,5 mm
- Acier galvanisé



- Rahmenteil für Holzzarge
- Länge 38,5 mm
- Stahl verzinkt



- Hinge component for wood frame
- Length 38,5 mm
- Steel zinc plated



 Deurstoppers

 Arrêts de porte

 Türstopper

 Doorstops

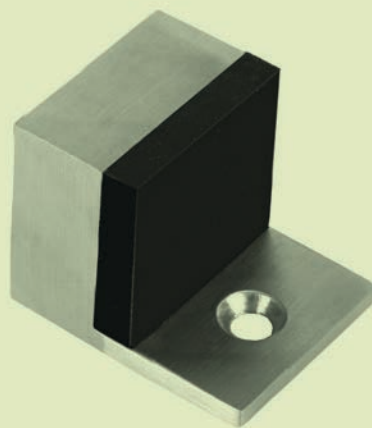



Project: Damc Tower
Architect: Versace Interiors

Deurstoppers
 Arrêts de porte
 Türstopper
 Doorstops



01995 380



01999 380



02030 381



02004 381



02001 381



01996 382



01997 382



01989 382



01990 383



01992 383



01994 383

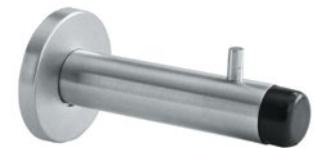

01993 383



01991 384



02034 - 48 mm 384

02036 - 60 mm 384

02003 - 78 mm 384

Deurstoppers / Arrêts de porte / Türstopper / Doorstops

Vloermontage / Montage au sol / Bodenmontage / Floormounted



01995



- Deurstopper
- Ø 56 mm x 47 mm(L) x 16 mm(H)
- RVS mat geborsteld



- Arrêt de porte
- Ø 56 mm x 47 mm(L) x 16 mm(H)
- Inox mat brossé



- Türstopper
- Ø 56 mm x 47 mm(L) x 16 mm(H)
- Edelstahl matt gebürstet



- Doorstop
- Ø 56 mm x 47 mm(L) x 16 mm(H)
- Satin stainless steel

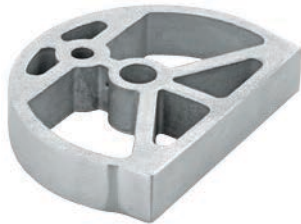
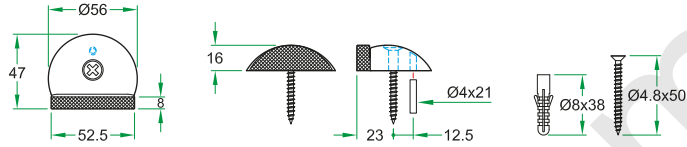

01032



- RVS verhoger
- 52 x 43 x 10 mm(H) voor 01995
- Mat geborsteld



- Rehausseur inox
- 52 x 43 x 10 mm(H) pour 01995
- Mat brossé



- Edelstahl Unterlegplatte
- 52 x 43 x 10 mm(H) für 01995
- Matt gebürstet



- Stainless steel base
- 52 x 43 x 10 mm(H) for 01995
- Satin finish

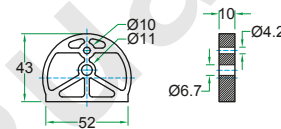

01999



- Deurstopper
- Ø 57,2 mm x 63 mm(L) x 24,2 mm(H)
- RVS mat geborsteld



- Arrêt de porte
- Ø 57,2 mm x 63 mm(L) x 24,2 mm(H)
- Inox mat brossé



- Türstopper
- Ø 57,2 mm x 63 mm(L) x 24,2 mm(H)
- Edelstahl matt gebürstet



- Doorstop
- Ø 57,2 mm x 63 mm(L) x 24,2 mm(H)
- Satin stainless steel

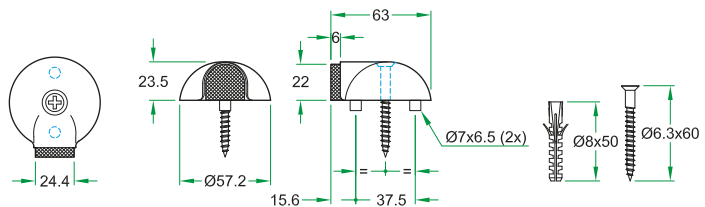

01020



- Rubber verhoger
- Ø 57 mm x 10 mm(H) voor 01999



- Rehausseur du caoutchouc
- Ø 57 mm x 10 mm(H) pour 01999



- Gummi Unterlegplatte
- Ø 57 mm x 10 mm(H) für 01999



- Rubber base
- Ø 57 mm x 10 mm(H) for 01999

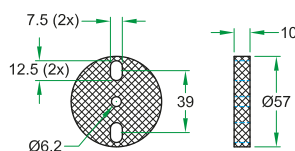

Deurstoppers / Arrêts de porte / Türstopper / Doorstops

Vloermontage / Montage au sol / Bodenmontage / Floormounted



02030



- Deurstopper
- Ø 84 mm x 87 mm(L) x 27,8 mm(H)
- RVS mat geborsteld



- Arrêt de porte
- Ø 84 mm x 87 mm(L) x 27,8 mm(H)
- Inox mat brossé



- Türstopper
- Ø 84 mm x 87 mm(L) x 27,8 mm(H)
- Edelstahl matt gebürstet



- Doorstop
- Ø 84 mm x 87 mm(L) x 27,8 mm(H)
- Satin stainless steel

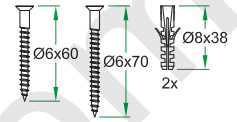
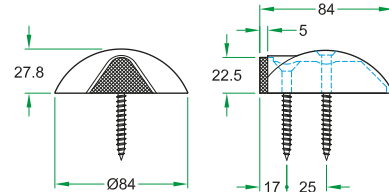
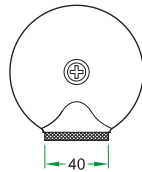

01019



- Rubber verhoger
- Ø 83,5 mm x 12 mm(H)
- voor 02030



- Rehausseur du caoutchouc
- Ø 83,5 mm x 12 mm(H)
- pour 02030



- Gummi Unterlegplatte
- Ø 83,5 mm x 12 mm(H)
- für 02030



- Rubber base
- Ø 83,5 mm x 12 mm(H)
- for 02030

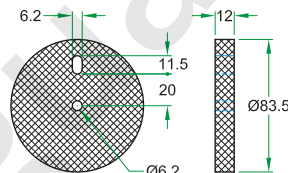

02004



- Deurstopper
- Ø 30 mm x 40 mm(H)
- RVS mat geborsteld



- Arrêt de porte
- Ø 30 mm x 40 mm(H)
- Inox mat brossé



- Türstopper
- Ø 30 mm x 40 mm(H)
- Edelstahl matt gebürstet



- Doorstop
- Ø 30 mm x 40 mm(H)
- Satin stainless steel

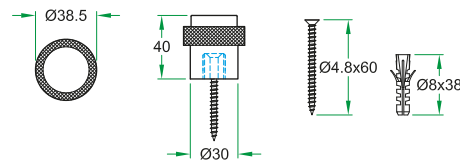

02001



- Deurstopper
- Ø 32 mm x 50 mm(H)
- RVS mat geborsteld



- Arrêt de porte
- Ø 32 mm x 50 mm(H)
- Inox mat brossé



- Türstopper
- Ø 32 mm x 50 mm(H)
- Edelstahl matt gebürstet



- Doorstop
- Ø 32 mm x 50 mm(H)
- Satin stainless steel

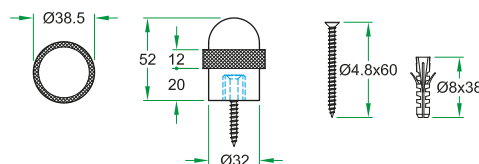

Deurstoppers / Arrêts de porte / Türstopper / Doorstops

Vloermontage / Montage au sol / Bodenmontage / Floormounted



01996



- Deurstopper
- Ø 43 mm x 24 mm(H)
- RVS mat geborsteld



- Arrêt de porte
- Ø 43 mm x 24 mm(H)
- Inox mat brossé



- Türstopper
- Ø 43 mm x 24 mm(H)
- Edelstahl matt gebürstet



- Doorstop
- Ø 43 mm x 24 mm(H)
- Satin stainless steel

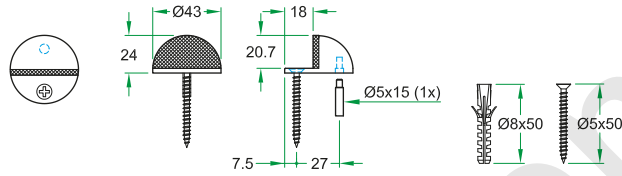

- Deurstopper
- Ø 25 mm x 25 mm(H)
- RVS mat geborsteld



- Arrêt de porte
- Ø 25 mm x 25 mm(H)
- Inox mat brossé



- Türstopper
- Ø 25 mm x 25 mm(H)
- Edelstahl matt gebürstet



- Doorstop
- Ø 25 mm x 25 mm(H)
- Satin stainless steel



01997

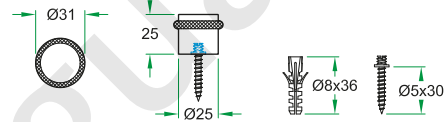

- Deurstopper
- □ 32 mm x 40 mm(L)
- RVS mat geborsteld



- Arrêt de porte
- □ 32 mm x 40 mm(L)
- Inox mat brossé



- Türstopper
- □ 32 mm x 40 mm(L)
- Edelstahl matt gebürstet



- Doorstop
- □ 32 mm x 40 mm(L)
- Satin stainless steel

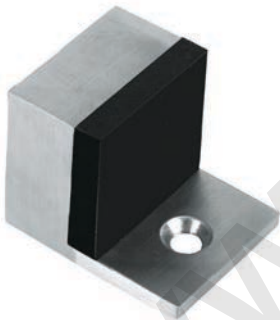

01989

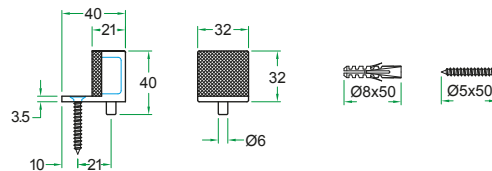

Deurstoppers / Arrêts de porte / Türstopper / Doorstops

Wandmontage / Montage au mur / Wandmontage / Wallmounted



01990



- Deurstopper
- □ 25 mm x 30 mm(H)
- RVS mat geborsteld



- Arrêt de porte
- □ 25 mm x 30 mm(H)
- Inox mat brossé



- Türstopper
- □ 25 mm x 30 mm(H)
- Edelstahl matt gebürstet



- Doorstop
- □ 25 mm x 30 mm(H)
- Satin stainless steel

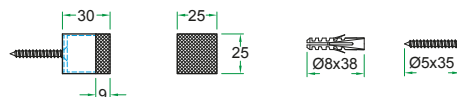

01992



- Deurstopper
- Ø 30 mm x 26 mm(H)
- RVS mat geborsteld



- Arrêt de porte
- Ø 30 mm x 26 mm(H)
- Inox mat brossé



- Türstopper
- Ø 30 mm x 26 mm(H)
- Edelstahl matt gebürstet



- Doorstop
- Ø 30 mm x 26 mm(H)
- Satin stainless steel



01994



- Wandrozet deurstopper Ø 30 mm
- Rubber buffer Ø 18 mm
- RVS mat geborsteld



- Arrêt de porte sur rosace Ø 30 mm
- Caoutchouc Ø 18 mm
- Inox mat brossé



- Wandtürstopper auf Rosette Ø 30 mm
- Gummi Ø 18 mm
- Edelstahl matt gebürstet



- Doorstop on rose Ø 30 mm
- Rubber Ø 18 mm
- Satin stainless steel

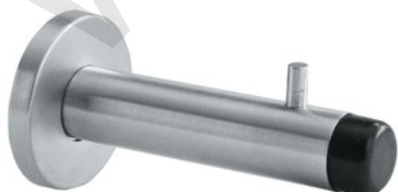
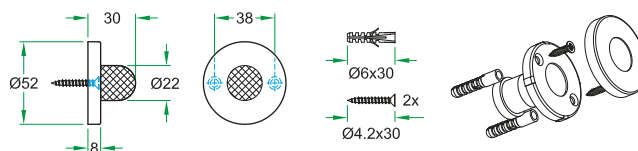

01993



- Deurstopper met haak
- Ø 18 mm x 91 mm(L)
- Op rozet Ø 45 mm
- RVS mat geborsteld



- Arrêt de porte avec patère
- Ø 18 mm x 91 mm(L)
- sur rosace Ø 45 mm
- Inox mat brossé



- Wandtürstopper mit Haken
- Ø 18 mm x 91 mm(L)
- auf Rosette Ø 45 mm
- Edelstahl matt gebürstet



- Doorstopper with hook
- Ø 18 mm x 91 mm(L)
- on rose Ø 45 mm
- Satin stainless steel

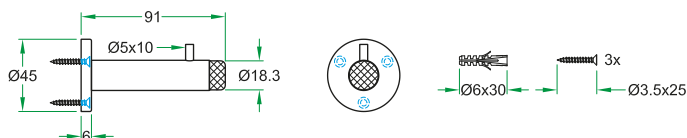

Deurstoppers / Arrêts de porte / Türstopper / Doorstops

Wandmontage / Montage au mur / Wandmontage / Wallmounted



- Deurstopper
- □ 25 mm x 78 mm(H)
- RVS mat geborsteld



- Arrêt de porte
- □ 25 mm x 78 mm(H)
- Inox mat brossé



- Türstopper
- □ 25 mm x 78 mm(H)
- Edelstahl matt gebürstet



- Doorstop
- □ 25 mm x 78 mm(H)
- Satin stainless steel

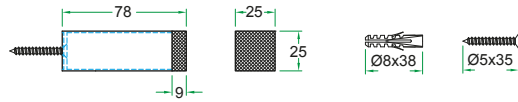

5C

01991



- Deurstopper
- Ø 25 x 48/60/78 mm(L)
- RVS mat geborsteld



- Arrêt de porte
- Ø 25 x 48/60/78 mm(L)
- Inox mat brossé



- Türstopper
- Ø 25 x 48/60/78 mm(L)
- Edelstahl matt gebürstet



- Doorstop
- Ø 25 x 48/60/78 mm(L)
- Satin stainless steel



Ø 25 mm x 48 mm (L)	02034
Ø 25 mm x 60 mm (L)	02036
Ø 25 mm x 78 mm (L)	02003



- RVS rozet
Ø 50 mm x 2,5 mm(H)
- Voor deurstoppers
02003, 02034, 02036
- Mat geborsteld



- Rosace de inox
Ø 50 mm x 2,5 mm(H)
- Pour arrêts de porte
02003, 02034, 02036
- Mat brossé



- Edelstahl Rosette
Ø 50 mm x 2,5 mm(H)
- Für Türstopper
02003, 02034, 02036
- Matt gebürstet



- Stainless steel rose
Ø 50 mm x 2,5 mm(H)
- For doorstops
02003, 02034, 02036
- Satin finish

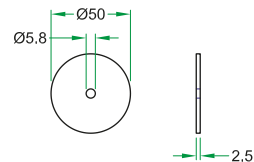

02035



  Schuifdeurkommen

  Cuvettes

 Schiebetürmuschel

 Sliding pulls

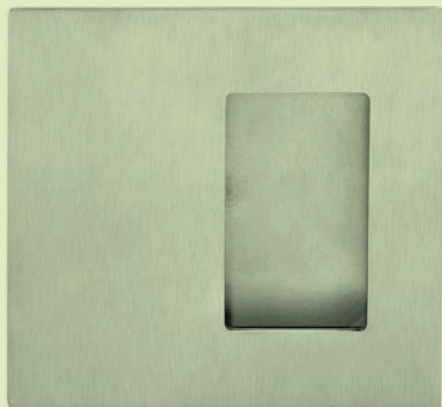

Schuifdeurkommen / Cuvettes / Schiebetürmuschel / Sliding pulls

RVS / Inox / Edelstahl / Stainless steel

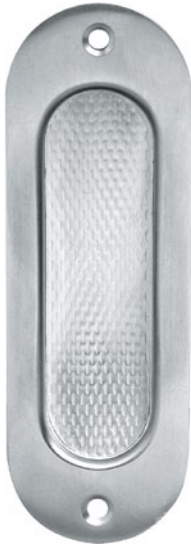

- Ovale schuifdeurkom
- RVS mat geborsteld



- Cuvette ovale
- Inox mat brossé



- Ovale Schiebetürmuschel
- Edelstahl matt gebürstet



- Oval sliding pull
- Satin stainless steel

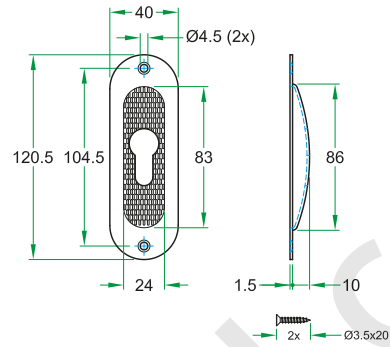

	01018
	01018/BB
	01018/PC

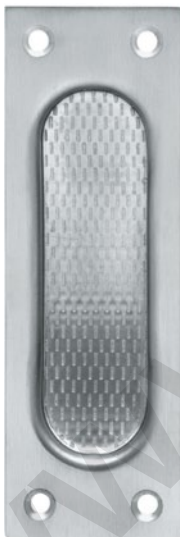

- Rechthoekige schuifdeurkom
- RVS mat geborsteld



- Cuvette rectangulaire
- Inox mat brossé



- Rechteckige Schiebetürmuschel
- Edelstahl matt gebürstet



- Rectangular sliding pull
- Satin stainless steel

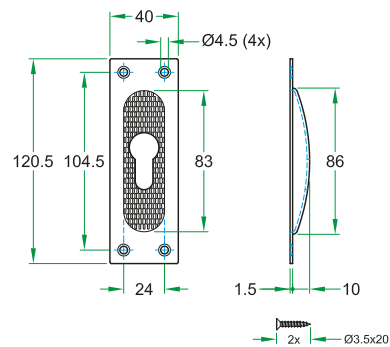

	01021
	01021/BB
	01021/PC

Schuifdeurkommen / Cuvettes / Schiebetürmuschel / Sliding pulls

RVS / Inox / Edelstahl / Stainless steel



- Ronde schuifdeurkom zonder sleutelgat
- RVS mat geborsteld



- Cuvette ronde sans BB
- Inox mat brossé



- Runde Schiebetürmuschel ohne Schlüsselloch
- Edelstahl matt gebürstet



- Round sliding pull without key hole
- Satin stainless steel

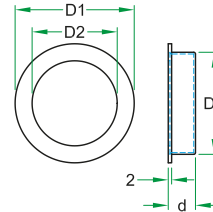

Art. Nr.	D1 mm	D2 mm	D3 mm	d mm
01022/40	Ø40	Ø27	Ø35	12
01022/50	Ø50	Ø33	Ø40	12
01022/70	Ø70	Ø50	Ø60	16

Ø 40 mm	01022/40
Ø 50 mm	01022/50
Ø 70 mm	01022/70

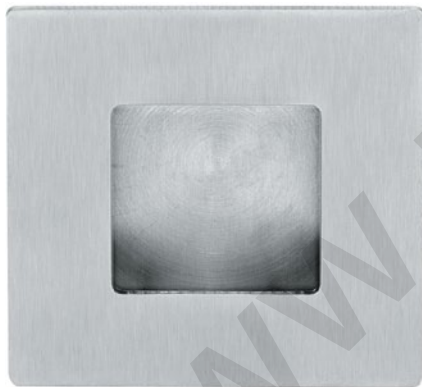

- Vierkante schuifdeurkom met gecentreerd gat zonder sleutelgat
- RVS mat geborsteld



- Cuvette carrée centré sans BB
- Inox mat brossé



- Eckige Schiebetürmuschel zentrierte Lochung ohne Schlüsselloch
- Edelstahl matt gebürstet



- Square sliding pull centered hole without key hole
- Satin stainless steel

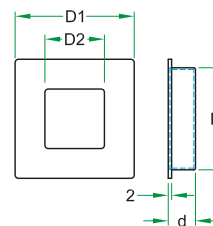

Art. Nr.	D1 mm	D2 mm	D3 mm	d mm
01023/50	□50	□23	Ø40	12
01023/70	□70	□35	Ø60	16

50 mm	01023/50
70 mm	01023/70

Schuifdeurkommen / Cuvettes / Schiebetürmuschel / Sliding pulls

RVS / Inox / Edelstahl / Stainless steel



- Vierkante schuifdeurkom met gecentreerd gat zonder sleutelgat
- RVS mat geborsteld



- Cuvette carrée centrée sans BB
- Inox mat brossé



- Eckige Schiebetürmuschel zentrierte Lochung ohne Schlüsselloch
- Edelstahl matt gebürstet



- Square sliding pull centered hole without key hole
- Satin stainless steel

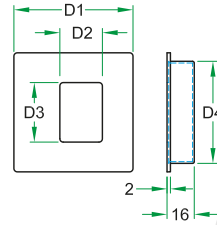
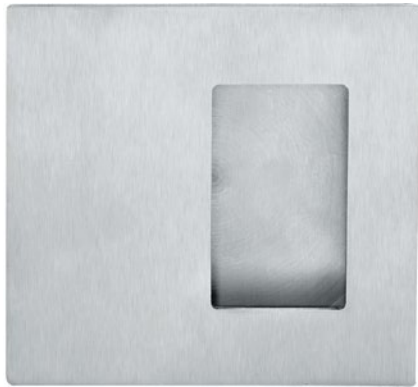

Art. Nr.	D1 mm	D2 mm	D3 mm	D4 mm
01024/70	□70	25	35	Ø60

70 mm

01024/70

  Raambeslag

  Quincaillerie de fenêtre

 Fenstergriff beschläge

 Window levers



5E



93542/R35

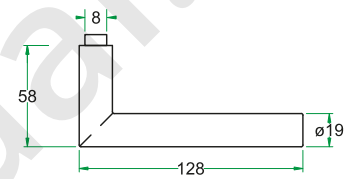
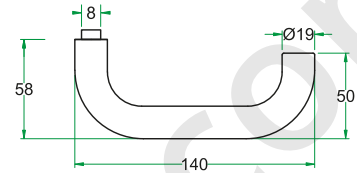
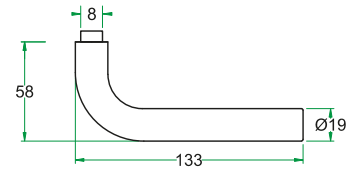
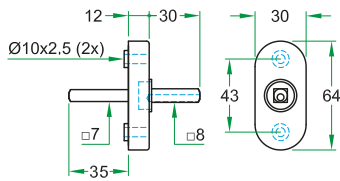

- RVS mat geborsteld
- Stalen onderconstructie met 90° draaikiep functie.
- Vierkantstift 8 > 7 mm
- Geschikt voor woningbouw
- Deurkruk separaat bestellen



- Inox mat brossé
- Sous construction avec fonction tournant 90°
- Tige 8 > 7 mm
- Propre pour usage dans la maison
- Béquille à commander séparément



- Edelstahl matt gebürstet
- Stahl Unterkonstruktion mit 90° Rasterung für Drehkippfunktion
- Vierkantstift 8 > 7 mm
- Einsetzbar für Wohnbereich
- Drücker separat bestellen



- Satin stainless steel
- Steel understructure with 90° turn & tilt function
- Square spindle 8 > 7 mm
- Suitable for residential use
- Order lever separately



	7 - 35 mm	93542/R35
		0981

	7 - 35 mm	93542/R35
		0982

	7 - 35 mm	93542/R35
		0983

 Pictogrammen

 Symboles

 Symbole

 Signage



Pictogrammen / Symboles / Symbole / Signage



02015



02016



02017



02018



02019



02020



02021



02022

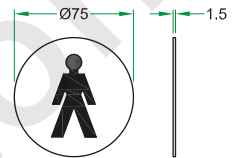

02025



02026



02027



02028



- Pictogrammen
- Ø 75 mm x 1,5 mm
- Zelfklevend
- RVS mat geborsteld



- Symboles
- Ø 75 mm x 1,5 mm
- Auto-adhésif
- Inox mat brossé



- Symbole
- Ø 75 mm x 1,5 mm
- Selbstklebend
- Edelstahl matt gebürstet



- Signage
- Ø 75 mm x 1,5 mm
- Self adhesive
- Satin stainless steel

Zonder gravering / Sans gravure / Ohne Gravierung / Without graphics	02015
Doucheruimte / Place de douche / Duscheraum / Shower room	02016
Baby ruimte / Place de bébé / Babyraum / Baby change	02017
Niet roken / Défense de fumer / Nicht rauchen / No smoking	02018
Heren-Dames / Hommes-Dames / Herren-Damen / Male-Female	02019
Heren / Hommes / Herren / Male	02020
Dames / Dames / Damen / Female	02021
Rolstoelgebruiker / Chaise roulante / Barrierefrei / Disabled	02022
Ziehen	02025
Drücken	02026
Trekken	02027
Duwen	02028

  Leuninghouders

  Supports de la rampe

 Handlaufstütze

 Handrailing supports

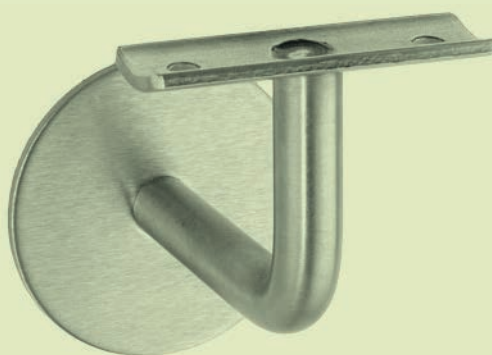

Leuninghouders / Supports de la rampe / Handlaufstütze / Handrailing supports

5G



- RVS leuninghouder
- Hol zadel
- Blinde montage M8 schroef
- Mat geborsteld



- Support de la rampe en inox
- Selle cave
- Montage invisible avec vis M8
- Mat brossé



- Edelstahl Handlaufstütze
- Hohles Sattel
- Unsichtbare Befestigung mit M8 Schraube
- Matt gebürstet



- Stainless steel handrail support holder
- Hollow saddle
- Invisible mounting with M8 Screw
- Satin finish



01025

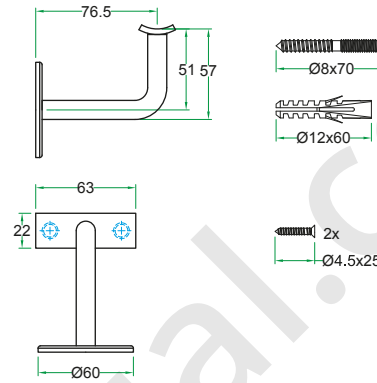

- RVS leuninghouder
- Vlak zadel
- Blinde montage M8 schroef
- Mat geborsteld



- Support de la rampe en inox
- Selle plate
- Montage invisible avec vis M8
- Mat brossé



- Edelstahl Handlaufstütze
- Flaches Sattel
- Unsichtbare Befestigung mit M8 Schraube
- Matt gebürstet



- Stainless steel handrail support holder
- Flat saddle
- Invisible mounting with M8 Screw
- Satin finish



01026

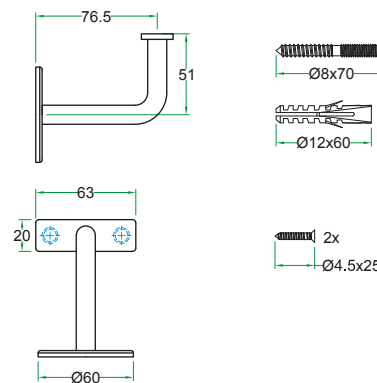

Leuninghouders / Supports de la rampe / Handlaufstütze / Handrailing supports



- RVS leuninghouder op rozet
- Hol zadel
- Mat geborsteld
- Zonder montageschroeven



01027



- Support de la rampe en inox sur rosace
- Selle cave
- Mat brossé
- Sans vis de fixation

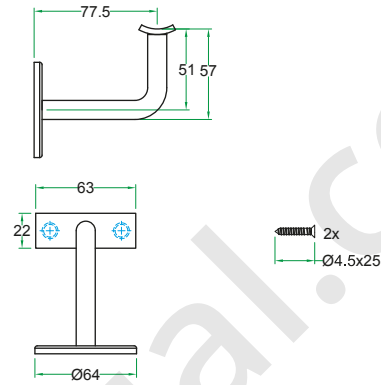

- Edelstahl Handlaufstütze auf Rosette
- Hohles Sattel
- Matt gebürstet
- Montageschrauben nicht miteingegriffen



- Stainless steel handrail support holder on rose
- Hollow saddle
- Satin finish
- Fixing screws not included



- RVS leuninghouder op rozet
- Vlak zadel
- Mat geborsteld
- Zonder montageschroeven



01028



- Support de la rampe en inox sur rosace
- Selle plate
- Mat brossé
- Sans vis de fixation

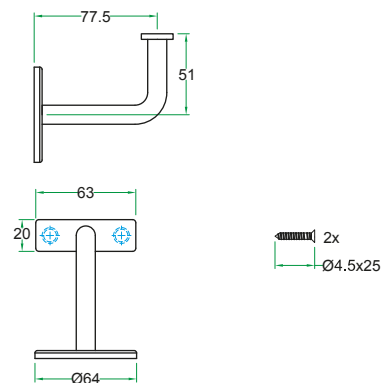

- Edelstahl Handlaufstütze auf Rosette
- Flaches Sattel
- Matt gebürstet
- Montageschrauben nicht miteingegriffen



- Stainless steel handrail support holder on rose
- Flat saddle
- Satin finish
- Fixing screws not included



MIBC, Moscow

 Jashaken

 Patères manteau

 Mantelhaken

 Coat hooks

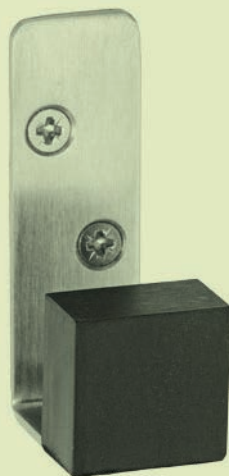

Jashaken / Patères manteau / Mantelhaken / Coat hooks

5H



01029



- RVS jashaak
- 63 mm(L) x 20 mm(B) x 2 mm(H)
- Mat geborsteld
- Incl. houtschroeven



- Patère manteau en inox
- 63 mm(L) x 20 mm(B) x 2 mm(H)
- Mat brossé
- Incl. vis de bois



- Edelstahl Mantelhaken
- 63 mm(L) x 20 mm(B) x 2 mm(H)
- Matt gebürstet
- Incl. wood screws



- Stainless steel coat hook
- 63 mm(L) x 20 mm(B) x 2 mm(H)
- Satin finish
- Incl. wood screws

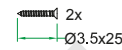
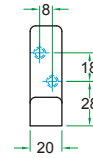
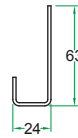

01030



- RVS jashaak
- 120 mm(L) x 20 mm(B) x 2 mm(H)
- Mat geborsteld
- Incl. houtschroeven



- Patère manteau en inox
- 120 mm(L) x 20 mm(B) x 2 mm(H)
- Mat brossé
- Incl. vis de bois



- Edelstahl Mantelhaken
- 120 mm(L) x 20 mm(B) x 2 mm(H)
- Matt gebürstet
- Incl. wood screws



- Stainless steel coat hook
- 120 mm(L) x 20 mm(B) x 2 mm(H)
- Satin finish
- Incl. wood screws

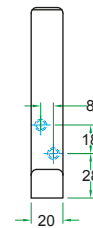
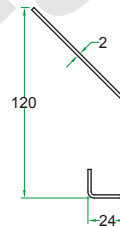

01031



- Rubber buffer voor 01029-01030
- Optionele accessoire



- Arrêt du caoutchouc pour 01029-01030
- Accessoire optionele



- Gummi Puffer für 01029-01030
- Optionelles Zubehörteil



- Rubber buffer for 01029-01030
- Optional part

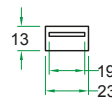

Jashaken / Patères manteau / Mantelhaken / Coat hooks



- Jas ophangmodule
- 282 mm(L) x 285 mm(H)
- RVS mat geborsteld



- Module accrocher pour le manteau
- 282 mm(L) x 285 mm(H)
- Inox mat brossé



- Mantelhaken Modul
- 282 mm(L) x 285 mm(H)
- Edelstahl matt gebürstet



- Coathook module
- 282 mm(L) x 285 mm(H)
- Satin stainless steel

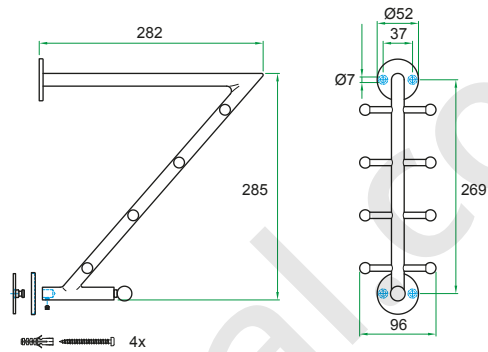

01001

5H



  Overige informatie

  Autre information

 Übrige Information

 Other information

NIEUW • NOUVEAU • NEU • NEW



Chase EN91055



Boda EN91029

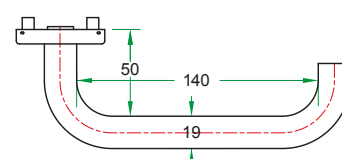
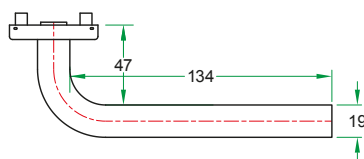
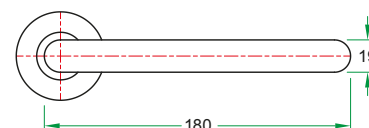
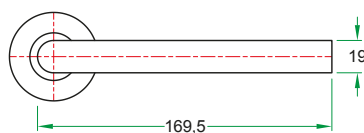

NIEUW • NOUVEAU • NEU • NEW

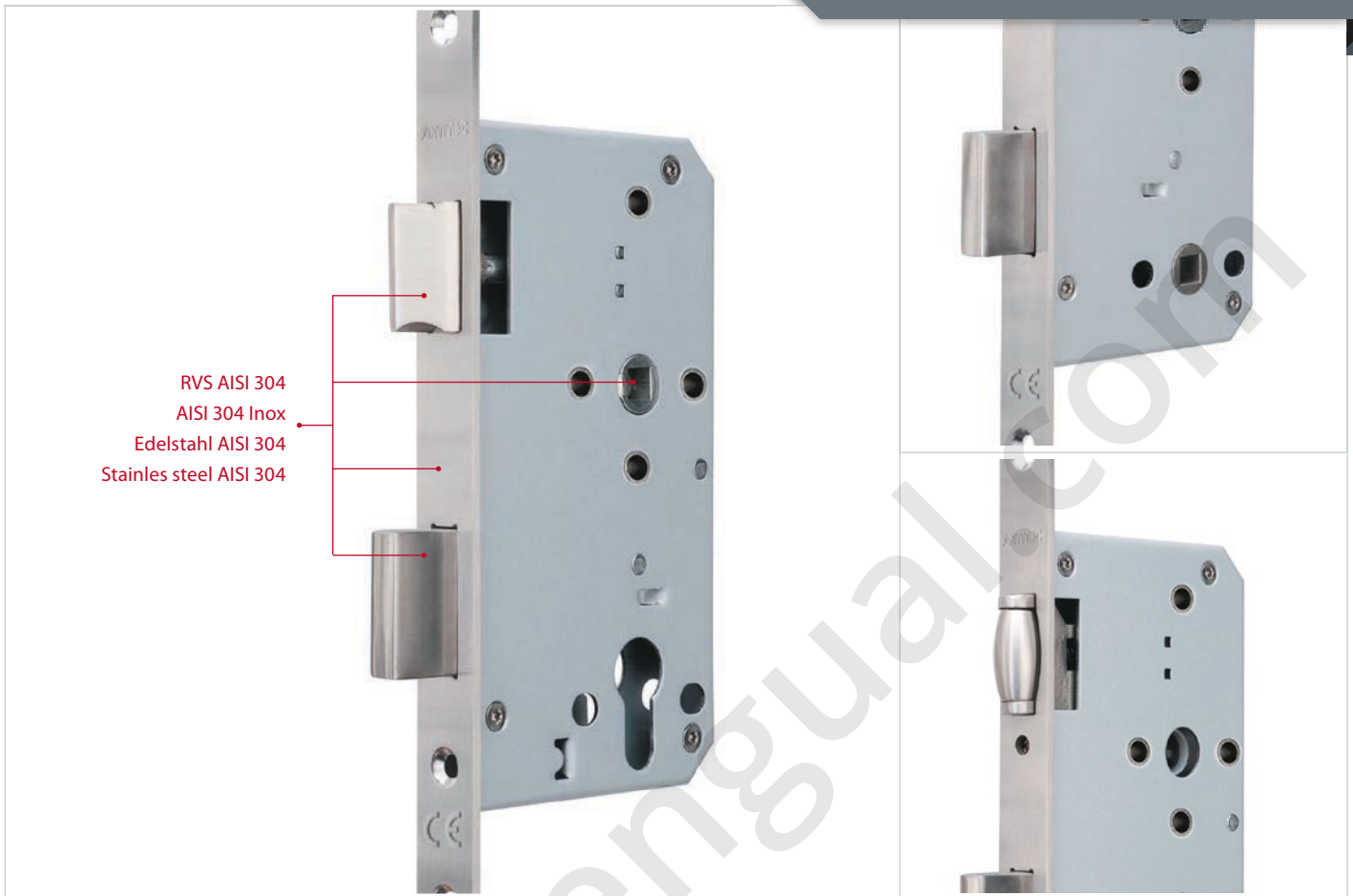

6A

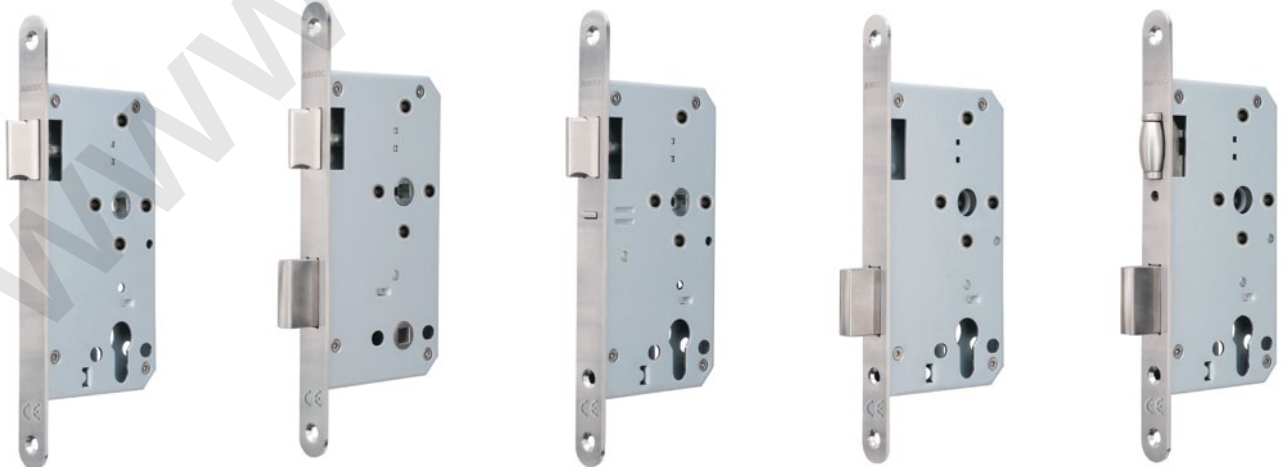

Voet-opener • Ouvrier de pied • Fußöffner • Foot-opener

NIEUW • NOUVEAU • NEU • NEW



6A



RVS voet-opener,
mat geborsteld

Ouvrier de pied en inox massif,
mat brossé

Edelstahl Fußöffner,
matt gebürstet

Stainless steel foot-opener,
satin finish

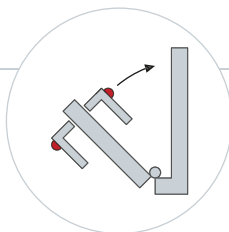

Prado



Rivamonte



Manhattan



Tiffany Black

NIEUW • NOUVEAU • NEU • NEW



Livanto



Condotti

NIEUW • NOUVEAU • NEU • NEW



Laura SE



Dorina SE

SHARP
EDGE



2 MM Rozet / Rosace / Rosette / Rose FR & FS

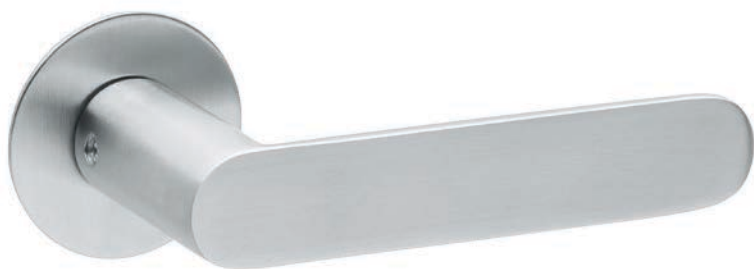

Polo FR

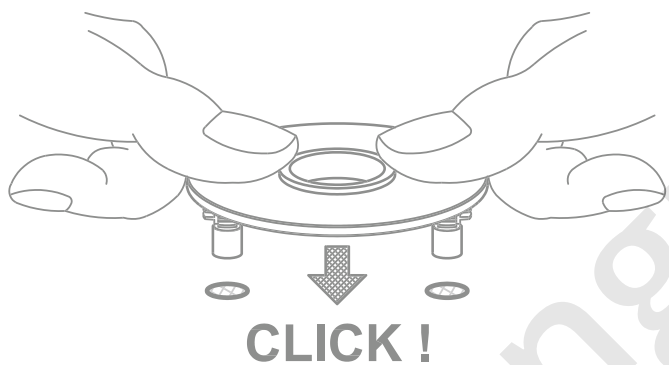

6A

NIEUW • NOUVEAU • NEU • NEW

2 MM



Lana FS

NIEUW • NOUVEAU • NEU • NEW

6A



NIEUW • NOUVEAU • NEU • NEW

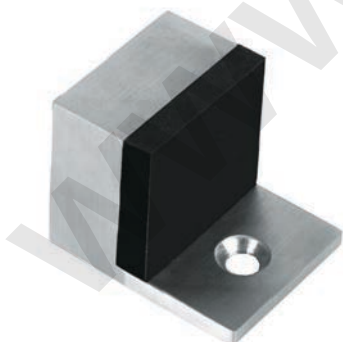

6A



- Innovatief
- Moderne logistiek
- Eigen productie
- Betrouwbaar
- Maatwerk altijd mogelijk
- Ontwikkeling in eigen huis
- Internationaal



- Innovateur
- Logistique moderne
- Production propre
- Fiable
- Mésures spéciales toujours possible
- Développement dans la propre maison
- International





- Innovativ
- Moderne Logistik
- Eigene Produktion
- Zuverlässig
- Maßarbeit immer möglich
- Entwicklung im eigenen Haus
- International



- Innovative
- Modern logistics
- Own production
- Reliable
- Custom made solutions always possible
- In house development
- International

**6B**

EN1906-4 • Standaard - Standard

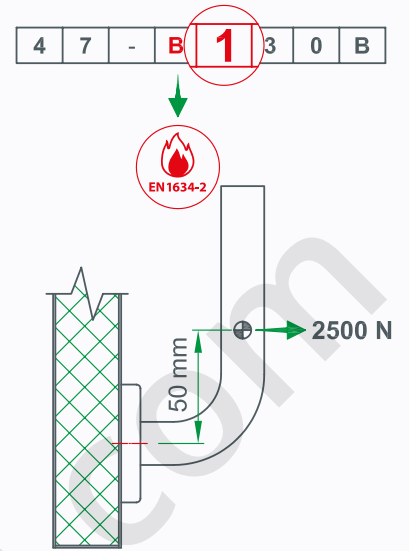
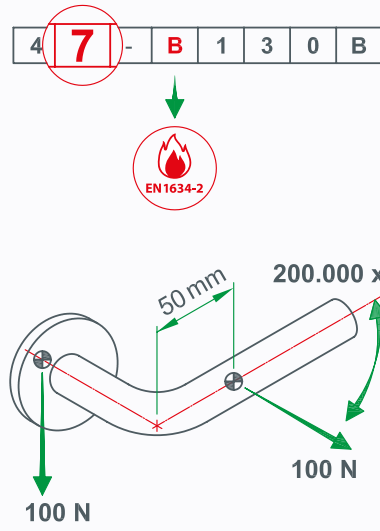
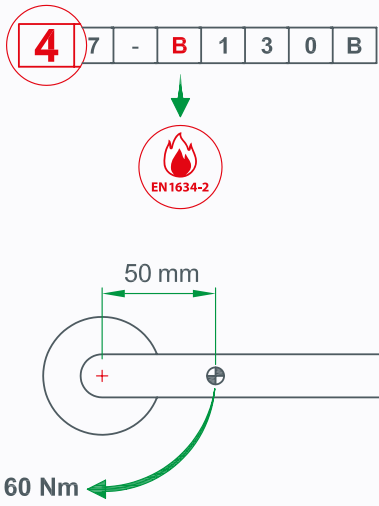

6C



Certificaten - Certificats - Zertifikate - Certificats



	<p>EU norm voor deurkrukken. '4': hoogste klasse (zéér sterk)</p>	<p>Norme européenne pour les poignées de porte. "4": Classe supérieure (très solide).</p>	<p>EU Norm Türbeschläge. '4': Klasse höchst (sehr stark)</p>	<p>EU standard for door handles. '4': highest grade (very strong).</p>
	<p>EU norm voor deurkrukken. '3': hoge klasse (sterk).</p>	<p>Norme européenne pour les poignées de porte. "3": Haute classe (solide).</p>	<p>EU Norm für Türbeschläge. '3': Klasse hoch (stark)</p>	<p>EU standard for door handles. '3': high grade (strong).</p>
	<p>EU norm voor brandwerendheid voor deurbeslag. '2' - getest op deurbeslag, 400°C en 30 min. brandwerend</p>	<p>Norme européenne pour la résistance au feu pour les garnitures de portes '2' - garnitures de portes testées, et 400 °C pendant 30 min feu.</p>	<p>EU Norm Feuerhemmung Türbeschläge. '2': getestet bei 400°C, bis 30 Minuten Feuerhemmend.</p>	<p>EU norm for fire-rated doorfurniture. "2" - doorfurniture tested at 400o C during 30 minutes.</p>
	<p>Duitse norm voor brandwerendheid. Brandwerend minimaal 1000°C en 120 minuten</p>	<p>Norme allemande en cas d'incendie. Doit supporter 1000°C et 120 min.</p>	<p>EU Norm Feuerhemmung. Türbeschläge. Getestet bei 1000°C, bis 120 Minuten Feuerhemmend.</p>	<p>German standard for fire doors (door hardware). Must withstand 1000°C and 120 min. fire resistance</p>
	<p>EU norm voor nooduitgangen (deurbeslag)</p>	<p>Norme européenne pour les issues de secours (garnitures de portes)</p>	<p>EU Norm Notausgänge (Türbeschläge)</p>	<p>EU standard for emergency doors (door hardware)</p>
	<p>Voltoet aan Integrale Toegankelijkheidsstandaard (ITS)</p>	<p>Rempli à la norme d'accessibilité integrale (ITS)</p>	<p>Entspricht der integralen Zugänglichkeitsnorm (ITS)</p>	<p>Conforms to integral accessiibity standard (ITS)</p>
	<p>NL norm voor inbraakwerendheid. 3 sterren: hoogste klasse (5 min. inbraakwerend)</p>	<p>Norme néerlandaise contre le cambriolage, 3 étoiles: Classe supérieure (5 min. anti-éffraction)</p>	<p>NL Norm Einbruchhemmung. 3 Sterne: stark Einbuchhemmend (5 Min. Widerstand)</p>	<p>Dutch standard for burglary-resistance. 3 stars is highest grade (5 min. Resistance)</p>
	<p>Politie keurmerk mbt inbraakwerendheid. Is bovenop de SKG*** norm</p>	<p>Label de la police contre le cambriolage. Supérieur aux normes "SKG".</p>	<p>Qualitätszeichen Polizei Einbruchhemmung. Erhältlich neben dem SKG*** Norm</p>	<p>Dutch police standard for burglary-resistance. Is in addition to SKG standard SKG*** Norm</p>
	<p>Duitse norm voor inbraakwerendheid. ES1 is meest gangbare klasse in Duitsland</p>	<p>Norme allemande contre le cambriolage. ES1 est la classe la plus courante en Allemagne</p>	<p>DE Norm Einbruchhemmung. ES1 ist gebräuchlichste Klasse in Deutschland</p>	<p>German standard for burglary-resistance. ES1 is most common grade in Germany</p>
	<p>EU norm voor sloten. Moderner dan DIN 18251 '3' = hoge klasse (sterk). Geschikt voor utiliteitsbouw</p>	<p>Norme néerlandaise pour les serrures. Plus moderne que DIN 18251 "3"= Haute classe (solide). Destiné aux bâtiments d'utilité</p>	<p>EU Norm Türschlößer. Moderner als DIN 18251. '3' : Klasse hoch (stark). Geeignet für Objektbau</p>	<p>EU standard for locks. More modern than DIN 18251 standard. '3': high grade, suitable for public buildings.</p>
	<p>Duitse norm voor sloten. Is eigenlijk achterhaald door EN 12209. Let op! klasse 3 hier is minder sterk dan klasse 3 EN 1229 norm!</p>	<p>Norme allemande pour les serrures. A été découvert par EN 12209. Attention! 3ième classe ici est moins solide que la 3ième classe EN 12209!</p>	<p>DE Norm Türschlößer. Eigentlich überholt durch EN 12209. Achtung: EN 12209 Klasse 3 ist stärker als DIN 18251 Klasse 3</p>	<p>German standaard for locks. Has been superceded by EN12209. Note: DIN grade 3 is less strong than grade 3 EN12209!</p>

Meer informatie:
Zie onze website

Plus d'informations:
Voir notre site

Weitere Informationen:
Siehe unsere Website

More informatie:
Check our website

www.artitec.com



Maatwerk, speciale toepassingen
of uw eigen ontwerp?
Bel ons voor mogelijkheden,
prijzen en levertijd.



Mesures spéciales, applications
spéciales ou votre propre
conception?
Appelez-nous pour les options,
prix et délai de livraison

**6D**

RAL kleuren mogelijk.
RAL couleurs possibles.
RAL Farben möglich.
RAL colors possible.





Maßarbeit, Sonderfertigungen
oder Ihr eigenes Entwurf?
Informieren Sie sich bitte über
die Möglichkeiten, Preise und
Liefertermin.



Made to measure, special
applications or your own design?
Call us for options, pricing and
lead times.



-   **Bevestigingsmaterialen**
-   **Accessoires de fixation**
-   **Befestigungsmaterial**
-   **Fixing material**

Utiliteitsbouw - binnendeuren
Quincaillerie bâtiment utilitaire - portes intérieures
Objektbeschläge - Innentüren
Commercial door furniture - interior doors



Proline Classic

Rozet, kort- en langschild **4**
 Rosace, plaque courte & plaque longue **4**
 Rosette, Kurz- und Langschild **4**
 Rose, short plate and long plate **4**

1C 40

Extra brandwerend DIN 18373 - 9 mm 
 Feu extra repoussant DIN 18273 - 9 mm 
 Feuerschutz laut DIN 18273 - 9 mm 
 Fire rated as per DIN 18273 - 9 mm 

1D 48

XL-Langschilden **4**
 Plaques longues XL **4**
 Langschilder XL **4**
 Longplates XL **4**

1E 56

Permafex proline **4 3**

1F 75-76

Slimface

1G 84

Profieldeurbeslag **4**
 Porte en métal & à chassis profil **4**
 Metall & Schmalrahmen **4**
 Metal doors & profile doors **4**

1H 98

Schuifdeurbeslag
 Porte coulissante
 Schiebetür
 Sliding door

1I 105

Veiligheidsbeslag
Quincaillerie de sécurité
Schutzbeschläge
Security hardware

TOP langschilden SKG***
 TOP plaque longue
 TOP Langschilder
 TOP long plates

4B 309

PRIO langschilden SKG***
 PRIO plaque longue
 PRIO Langschilder
 PRIO long plates

4C 317

NOVA Rozetten SKG*** & ES1
 NOVA Rosaces
 NOVA Rosetten
 NOVA roses

4D 321-322

DIN Draairichting / Sens de rotation / Drehrichtung / Turn direction

DIN 'L'
Links / Gauche / Left

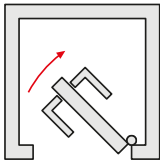
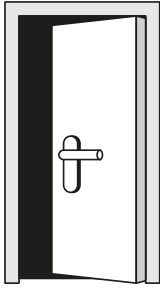

DIN 'R'
Rechts / Droite / Right

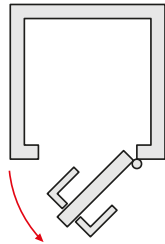
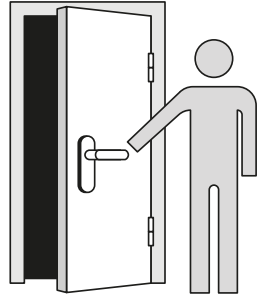

DIN 'L'
Links / Gauche / Left

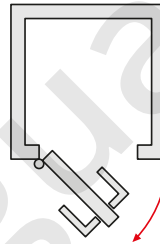
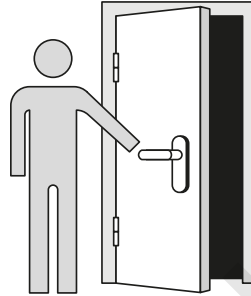

DIN 'R'
Rechts / Droite / Right

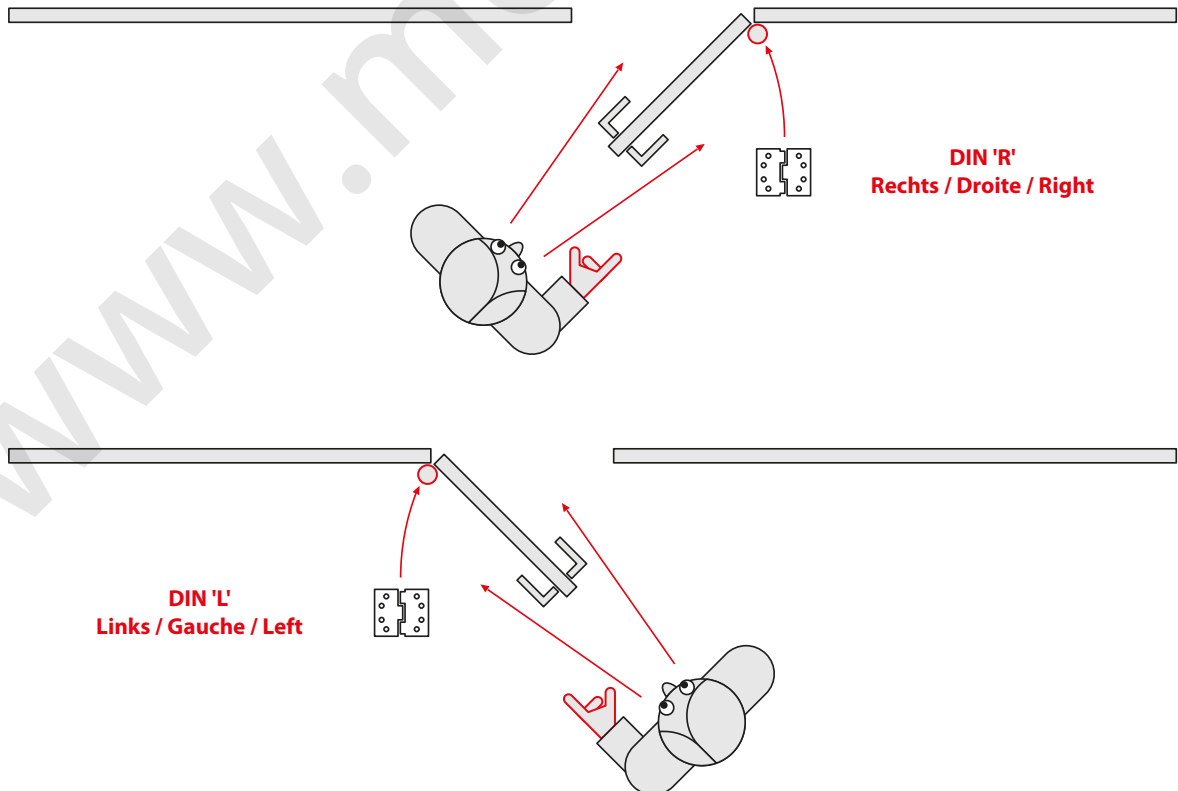
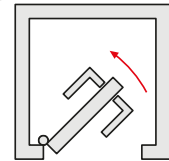
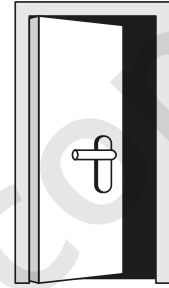

Index

Utiliteitsbouw - binnendeuren	7	Plates	54	Rondo	95
Quincaillerie bâtiment utilitaire -		Schilden	54	Rosaces	97
Portes intérieures	7	Schilder	54	Roses	97
Objektbesläge - Innentüren	7	Zubehör	56	Rosetten	97
Commercial doorfurniture - Interior doors	7	PERMAFIX proline	57	Rozetten	97
Proline Classic EN1906-4	13	Accessoires	75	Tessa	92
Accessoires	40	Bauhaus EN1906-3	61	Tessa Detour	94
Boda EN91029	18	Bauhaus EN1906-4	60	Tessa II	93
Boda EN91029	19	Boutons	73	Zubehör	98
Boda EN91030	16	Cecil EN1906-3	63	Schuifdeur	99
Boda EN91030	17	Cecil EN1906-4	62	Porte coulissante	99
Boda EN91030	20	Fabio EN1906-3	65	Schiebetür	99
Boda EN91030	21	Fabio EN1906-4	64	Sliding door	99
Boutons	37	Knobs	73	Accessoires	105
Champ EN91078	32	Knöpfe	73	Chase	102
Champ EN91078	33	Knoppen	73	Chase	103
Chase EN91050	22	Leona EN1906-3	67	Chase	104
Chase EN91050	23	Leona EN1906-4	66	Cuvettes	106
Chase EN91050	26	Noa EN1906-3	69	Onderdelen	105
Chase EN91050	27	Noa EN1906-4	68	Parts	105
Chase EN91055	24	Onderdelen	75	Schiebetürmuschel	106
Chase EN91055	25	Parts	75	Schuifdeurkommen	106
Fame EN97719	34	Rosaces	72	Sliding pulls	106
Fame EN97719	35	Roses	72	Zubehör	105
Knobs	37	Rosetten	72	Projectsloten	109
Knöpfe	37	Rozetten	72	Serrures de projets	109
Knoppen	37	Tavira EN1906-3	71	Einsteckschlößer	109
Onderdelen	40	Tavira EN1906-4	70	Mortice locks	109
Parts	40	Zubehör	75	Voet-opener	115
Plaques	38	Slimface	77	Ouvrier de pied	115
Plates	38	Accessoires	84	Fußöffner	115
Rosaces	36	Boda 16 mm	80	Foot-opener	115
Roses	36	Boutons	82	Zorg & Welzijn - binnendeuren	119
Rosetten	36	Knobs	82	Soins & Bien-être - portes intérieures	119
Rozetten	36	Knöpfe	82	Pflege & Wohl - Innentüren	119
Schilden	38	Knoppen	82	Care & Welfare - Interior doors	119
Schilder	38	Onderdelen	84	Infectiepreventie	120
Tessa EN91070	28	Parts	84	Prévention des infections	120
Tessa EN91070	29	Rosaces	83	Infektion Prävention	121
Tessa EN91070	30	Roses	83	Infektion prevention	121
Tessa EN91070	31	Rosetten	83	Chase	125
Zubehör	40	Rozetten	83	HC3 Anti-microbiële coating	126
Proline Classic DIN 18273	41	Tessa 16 mm	81	Le revêtement Antimicrobielle HC3	127
Accessoires	48	Zubehör	84	Antimikrobielle HC3-Beschichtung	128
Chase 91050	44	Profieldeurbeslag	85	HC3 Anti-microbial coating	129
Chase 91050	45	Quincaillerie de porte à chassis profil	85	Suicide Preventie Beslag	130
Onderdelen	48	Schmalrahmen	85	Quincaillerie de prévention contre le suicide	130
Parts	48	Profile door hardware	85	Suizid-hemmende Ausstattungen	131
Tessa 91070	46	Accessoires	98	Anti-Ligature Fittings	131
Tessa 91070	47	Boda	88	Suicide Preventie Beslag	132
Tessa 91070	31	Boutons	96	Quincaillerie de prévention contre	
Zubehör	48	Chase	89		
XL EN1906-4	49	Chase II	90		
Accessoires	56	Cindy	91		
Boda XL EN91030	52	Knobs	96		
Chase XL EN91050	53	Knöpfe	96		
Onderdelen	56	Knoppen	96		
Parts	56	Onderdelen	98		
Plaques	54	Parts	98		

Index

le suicide	132	Knoppen	234	Langschilder	255
Suizid-hemmende Ausstattungen	132	Lana	203	Long plates	255
Anti-Ligature Fittings	132	Lana FR	205	Béquilles pour plaques	262
Woningbouw - binnendeuren	147	Lana FS	206	Deurkrukken voor schilden	262
Quincaillerie résidentielle -		Lana SE	204	Drücker für Schilder	262
portes intérieures	147	Laura	207	Levers for plates	262
Wohnbereich - Innentüren	147	Laura FS	209	Ton - Jaren 30 Stijl	265
Residential door furniture - Interior doors	147	Laura SE	208	Ton - Le style des années 30	265
Luxuria Design Collection	151	Lido	210	Ton - 30. Jahre Stil	265
5 th Avenue	154	Metro	211	Ton - 30th Style	265
Condotti	155	Pipo	212	Interior Accents	273
Condotti	156	Polo	213	Anika	276
Livanto	157	Polo FR	215	Dion	277
Manhattan	158	Polo FS	216	Futura	278
Manhattan	159	Polo SE	214	Futura	279
Manhattan	160	Primo	217	Ibiza	280
Prado	161	Saba	218	Lagos	281
Rivamonte	162	Saba FR	220	Lubi	282
Serrano	163	Saba SE	219	Lubi	283
Soho	164	Sabrina	221	Napa	284
Tiffany	165	Sabrina FS	222	Seville	285
Tiffany	166	Sipo	223	Sienna	286
Tirza	168	Tec	224	Space	287
Tirza	169	Tipo	225	Viva	288
Tivoli	167	Tipo FR	227	'Black is Beautiful'	289
Urban	170	Tipo FRP	228	Lana	290
Urban	171	Tipo FS	229	Tipo	291
Urban	172	Tipo FSP	230	Profieldeur	293
Urban	173	Tipo SQ	226	Porte à chassis profile	293
Versa	174	Uno	231	Schmallrahmen	293
Versa	175	Vogue	232	Profile door	293
Vola	176	Wing	233	Clara	295
Vola	177	Vastdraaibaar op rozet zonder nokken	237	Lido	296
Vola	178	Fixe sur rosace sans cames	237	Rosaces	298
Vola	179	Festdrehbar auf Rosette ohne Nocken	237	Roses	298
Collectie RVS deurkrukken	181	Fixed with spring on rose without lugs	237	Rosetten	298
Collection béquilles en inox	181	Donna	239	Rozetten	298
Kollektion Edelstahl Türdrücker	181	Lima Ø 16 mm	240	Tipo	297
Collection stainless steel levers	181	Lita	241	Buitendeuren	301
Boutons	234	Tria Ø 16 mm	242	Portes extérieures	301
Cino	189	Trio	243	Außentüren	301
Dorina	190	Vastdraaibaar op schroefrozet	245	Exterior doors	301
Dorina FR	192	Fixe sur rosace spirale	245	Veiligheidsbeslag	302
Dorina SE	191	Festdrehbar auf Überschraubrossette	245	Quincaillerie de sécurité	302
Fiona	193	Fixed with spring on threaded rose	245	Schutzbeschläge	302
Gino	194	Boutons	254	Security Hardware	302
Gisela	195	Dorina SC	248	Accessoires TOP	309
Gisela FR	197	Gino SC	247	Accessoires PRIO	317
Gisela SE	196	Knobs	254	Béquille	318
Hala	198	Knöpfe	254	Bouton	319
Ilsa	199	Knoppen	254	Deurkruk	318
Jade	200	Lalita SC	249	Drücker	318
Karina	201	Seville SC	250	Knob	319
Karina FS	202	Space SC	251	Knop	319
Knobs	234	Tipo SC	252		
Knöpfe	234	Uno SC	253		
		Langschilden	255		
		Plaques longues	255		

Index

Knopf	319	Letterplate shaft	333	Sliding pulls	385
Lever	318	Lettres	335	Raambeslag	389
NOVA	321	Luna	331	Quincaillerie de fenêtre	389
NOVA	322	Orion	331	Fenstergriff beschläge	389
Onderdelen TOP	309	Orion	332	Window levers	389
Onderdelen PRIO	317	Quadra	331	Pictogrammen	391
Parts TOP	309	Quadra	332	Symboles	391
Parts PRIO	317	Sonnette	334	Symbole	391
Plaques TOP	308	Star	330	Signage	391
Plaques PRIO	316	Tavira	329	Leuninghouders	393
Plates TOP	308	Tochtplaat	333	Supports de la rampe	393
Plates PRIO	316	Zugklappe	333	Handlaufstütze	393
PRIO	311			Handrailing supports	393
PRIO	312	Algemeen	337	Jashaken	397
PRIO	313	General	337	Patères manteau	397
PRIO	314	Allgemein	337	Mantelhaken	397
PRIO	315	General	337	Coat hooks	397
Schilden TOP	308	Deurgrepen	339	Overige informatie	401
Schilden PRIO	316	Tirants	339	Autre information	401
Schilder	308	Stoßgriffe	339	Úbrige Information	401
Schilder	316	Pull Handles	339	Other information	401
TOP	303	Befestigung	359		
TOP	304	Bevestiging	359		
TOP	305	Fixation	359		
TOP	306	Mounting	359		
TOP	307	PH30	344		
Zubehör TOP	309	PH31	345		
Zubehör PRIO	317	PH50	346		
		PH54	347		
Profiel deur rozetten	323	PH55	348		
Porte à chassis profil rosaces	323	PH60	349		
Schmalrahmen Rosetten	323	PH61	350		
Profile door roses	323	PH62	351		
Rosaces	325	PH63	352		
Roses	325	PH64	353		
Rosetten	325	PH65	354		
Rosetten	325	PH66	355		
Voordeurbeslag	327	PH70	356		
Garnitures de portes	327	PH85	357		
Haustürbeschläge	327	PH90	358		
Entrance hardware	327	Glasdeurbeslag	361		
Arbre de boîte aux lettres	333	Quincaillerie pour porte en verre	361		
Beldrukker	334	Glastürbeschläge	361		
Bell push	334	Glass door hardware	361		
Briefeinwurfschaft	333	Frankfurt	364		
Buchstaben	335	München	365		
Cecil	328	Office	366		
Chiffres	335	Star	372		
Courant d'air	333	Deurstoppers	377		
Entro 50	330	Arrêts de porte	377		
Entro 67	330	Türstopper	377		
Hausnummer	335	Doorstops	377		
House letters	335	Schuifdeurkommen	385		
House numbers	335	Cuvettes	385		
Huiscijfers	335	Schiebetürmuschel	385		
Huisletters	335				
KeyGlow	336				
Klingelplatte	334				
Leona	328				

Index

000KU	235	2R11.WCX	218	00123-WCX	225	00800-WCX	262	0981	318
2R10.T8.WCX	189	2R11.WCX	223	00121-SQ	226	00801-WCX	200	00982	204
2R10.T8.WCX	190	2R11.WCX	225	00122-SQ	226	00802-WCX	200	0982	318
2R10.T8.WCX	193	2R11.WCX	231	00126-SQ	226	00803-WCX	200	00983	204
2R10.T8.WCX	194	2R11.WCX	233	00126-WCX	225	00806-WCX	200	0983	318
2R10.T8.WCX	195	2R11.WCX	278	00126-WCX/BL	291	00820	262	0984	318
2R10.T8.WCX	198	2R11.WCX/BL	290	00140-WCX	263	00821-WCX	195	0985	318
2R10.T8.WCX	199	2R11.WCX/BL	291	00141-WCX	212	00822-WCX	195	00986	204
2R10.T8.WCX	200	2R12.WCX	189	00142-WCX	212	00823-WCX	195	00991	205
2R10.T8.WCX	203	2R12.WCX	190	00143-WCX	212	00826-WCX	195	00992	205
2R10.T8.WCX	210	2R12.WCX	193	00146-WCX	212	00840-WCX	262	00993	205
2R10.T8.WCX	212	2R12.WCX	194	00151-WCX	223	00841-WCX	199	00996	205
2R10.T8.WCX	213	2R12.WCX	195	00152-WCX	223	00842-WCX	199	01001	399
2R10.T8.WCX	217	2R12.WCX	198	00153-WCX	223	00843-WCX	199	01018	106
2R10.T8.WCX	218	2R12.WCX	199	00156-WCX	223	00846-WCX	199	01018	386
2R10.T8.WCX	223	2R12.WCX	200	00180-WCX	262	00850-WCX	263	01018/BB	106
2R10.T8.WCX	225	2R12.WCX	203	00181-WCX	194	00851-WCX	233	01018/BB	386
2R10.T8.WCX	231	2R12.WCX	210	00182-WCX	194	00852-WCX	233	01018/PC	106
2R10.T8.WCX	233	2R12.WCX	212	00183-WCX	194	00853-WCX	233	01018/PC	386
2R10.T8.WCX	278	2R12.WCX	213	00186-WCX	194	00856-WCX	233	01019	381
2R10.T8.WCX/BL	290	2R12.WCX	217	00190-WCX	262	00861-WCX	198	01020	380
2R10.T8.WCX/BL	291	2R12.WCX	218	00191-WCX	189	00862-WCX	198	01021	106
2R10.T67.WCX	189	2R12.WCX	223	00192-WCX	189	00863-WCX	198	01021	386
2R10.T67.WCX	190	2R12.WCX	225	00193-WCX	189	00866-WCX	198	01021/BB	106
2R10.T67.WCX	193	2R12.WCX	231	00196-WCX	189	00881-WCX	193	01021/BB	386
2R10.T67.WCX	194	2R12.WCX	233	00261	281	00882-WCX	193	01021/PC	106
2R10.T67.WCX	195	2R12.WCX	278	00262	281	00883-WCX	193	01021/PC	386
2R10.T67.WCX	198	2R12.WCX/BL	290	00263	281	00886-WCX	193	01022/40	107
2R10.T67.WCX	199	2R12.WCX/BL	291	00266	281	00890-WCX	263	01022/40	387
2R10.T67.WCX	200	2R30.SE	191	00271	287	00891-WCX	217	01022/50	107
2R10.T67.WCX	203	2R30.SE	196	00272	287	00892-WCX	217	01022/50	387
2R10.T67.WCX	210	2R30.SE	204	00273	287	00893-WCX	217	01022/70	107
2R10.T67.WCX	212	2R30.SE	208	00276	287	00896-WCX	217	01022/70	387
2R10.T67.WCX	213	2R30.SE	214	00451	278	00900	262	01023/50	107
2R10.T67.WCX	217	2R30.SE	219	00452	278	00901	209	01023/50	387
2R10.T67.WCX	218	2R30.T8.SE	191	00453	278	00902	209	01023/70	107
2R10.T67.WCX	223	2R30.T8.SE	196	00456	278	00903	209	01023/70	387
2R10.T67.WCX	225	2R30.T8.SE	204	00491	279	00906	209	01024/70	108
2R10.T67.WCX	231	2R30.T8.SE	208	00492	279	00910	263	01024/70	388
2R10.T67.WCX	233	2R30.T8.SE	214	00493	279	00911	220	01025	394
2R10.T67.WCX	278	2R30.T8.SE	219	00496	279	00912	220	01026	394
2R10.WCX	189	2R30.T67.SE	191	00500	262	00913	220	01027	395
2R10.WCX	190	2R30.T67.SE	196	00501	201	00916	220	01028	395
2R10.WCX	193	2R30.T67.SE	204	00502	201	00921	207	01029	398
2R10.WCX	194	2R30.T67.SE	208	00503	201	00922	207	01030	398
2R10.WCX	195	2R30.T67.SE	214	00506	201	00923	207	01031	398
2R10.WCX	198	2R30.T67.SE	219	00510	263	00926	207	01032	380
2R10.WCX	199	2R31.SE	191	00511	221	00931	218	01111	206
2R10.WCX	200	2R31.SE	196	00512	221	00932	218	01112	206
2R10.WCX	203	2R31.SE	204	00513	221	00933	218	01113	206
2R10.WCX	210	2R31.SE	208	00516	221	00936	218	01116	206
2R10.WCX	212	2R31.SE	214	00520	262	00940	263	01211	196
2R10.WCX	213	2R31.SE	219	00521	190	00941	213	01212	196
2R10.WCX	217	2R32.SE	191	00522	190	00942	213	01213	196
2R10.WCX	218	2R32.SE	196	00523	190	00943	213	01216	196
2R10.WCX	223	2R32.SE	204	00526	190	00946	213	01221	197
2R10.WCX	225	2R32.SE	208	00531	191	00951	214	01222	197
2R10.WCX	231	2R32.SE	214	00532	191	00952	214	01223	197
2R10.WCX	233	2R32.SE	219	00533	191	00953	214	01226	197
2R11.WCX	189	00100-WCX	263	00536	191	00956	214	01231	216
2R11.WCX	190	00101-WCX	210	00541	192	00961	215	01232	216
2R11.WCX	193	00102-WCX	210	00542	192	00962	215	01233	216
2R11.WCX	194	00103-WCX	210	00543	192	00963	215	01236	216
2R11.WCX	195	00106-WCX	210	00546	192	00966	215	01241	219
2R11.WCX	198	00110-WCX	263	00551	202	00970	262	01242	219
2R11.WCX	199	00111-WCX	231	00552	202	00971	203	01243	219
2R11.WCX	200	00112-WCX	231	00553	202	00972	203	01246	219
2R11.WCX	203	00113-WCX	231	00556	202	00973	203	01251	208
2R11.WCX	210	00116-WCX	231	00561	222	00976	203	01252	208
2R11.WCX	212	00120-WCX	263	00562	222	00976/BL	290	01253	208
2R11.WCX	213	00121-WCX	225	00563	222	0980	318	01256	208
2R11.WCX	217	00122-WCX	225	00566	222	00981	204	01989	382

Index

01990	383	03481	286	03594	224	04056	227	04212/T8	222
01991	384	03482	286	03594	226	04056/P	228	04212/T8	229
01992	383	03483	286	03594	232	04061	229	04212/T67	202
01993	383	03486	286	03594	279	04061/P	230	04212/T67	206
01994	383	03551	276	03596	201	04062	229	04212/T67	209
01995	380	03551	280	03596	207	04062/P	230	04212/T67	216
01996	382	03551	281	03596	211	04063	229	04212/T67	222
01997	382	03551	285	03596	221	04063/P	230	04212/T67	229
01999	380	03551	287	03596	224	04066	229	05000U	296
02001	381	03551	288	03596	226	04066/P	230	05002	296
02003	384	03552	276	03596	232	04101	192	05008	298
02004	381	03552	280	03596	279	04101	197	05010U	295
02015	392	03552	281	04000/BL	258	04101	205	05012	295
02016	392	03552	285	04000/PC72	258	04101	215	05020U	297
02017	392	03552	287	04001/BL	258	04101	220	05022	297
02018	392	03552	288	04001/OB56	258	04101	227	9420.U2060.DL	114
02019	392	03554S	276	04001/OB72	258	04101/P	228	9420.U2060.NL	113
02020	392	03554S	280	04001/OB90	258	04106	192	9420.U2060.PC72	112
02021	392	03554S	281	04001/PC55	258	04106	197	9420.U2060.PL	113
02022	392	03554S	285	04001/PC72	258	04106	205	9420.U2060.RB	114
02025	392	03554S	287	04001/PC90	258	04106	215	9420.U2060.WC72	113
02026	392	03554S	288	04001/WC63	258	04106	220	9420.U2060.WC78	113
02027	392	03555	276	04001/WC72	258	04106	227	26300/72	311
02028	392	03555	280	04001/WC78	258	04106/P	228	26300/92	311
02030	381	03555	281	04002/BL	257	04107	192	26301/72	314
02034	384	03555	285	04002/OB56	257	04107	197	26301/92	314
02035	384	03555	287	04002/OB72	257	04107	205	26302/72	312
02036	384	03555	288	04002/OB92	257	04107	215	26302/92	312
03201	282	03571	277	04002/OB110	257	04107	220	26303/72	315
03202	282	03571	282	04002/PC55	257	04107	227	26303/92	315
03203	282	03571	283	04002/PC72	257	04107/P	228	26304/72	313
03206	282	03571	284	04002/PC90	257	04112P/T8	228	26304/92	313
03211	283	03571	286	04002/PC92	257	04112P/T67	228	26305	316
03212	283	03572	277	04002/WC63	257	04112/T8	192	26306	316
03213	283	03572	282	04002/WC72	257	04112/T8	197	26450/72	303
03216	283	03572	283	04002/WC78	257	04112/T8	205	26450/92	303
03221	224	03572	284	04002/WC90	257	04112/T8	215	26451/72	306
03222	224	03572	286	04002/WC116	257	04112/T8	220	26451/92	306
03223	224	03574	277	04003/BL	257	04112/T8	227	26452/72	304
03226	224	03574	282	04003/PC72	257	04112/T67	192	26452/92	304
03231	288	03574	283	04004/BL	257	04112/T67	197	26453/72	307
03232	288	03574	284	04004/PC72	257	04112/T67	205	26453/92	307
03233	288	03574	286	04010/BL	259	04112/T67	215	26454/72	305
03236	288	03575	277	04010/PC72	259	04112/T67	220	26454/92	305
03241	211	03575	282	04011/BL	259	04112/T67	227	26455	308
03242	211	03575	283	04011/OB56	259	04201	202	26456	308
03243	211	03575	284	04011/OB72	259	04201	206	27024	36
03246	211	03575	286	04011/OB90	259	04201	209	27025	36
03251	276	03590	201	04011/PC55	259	04201	216	27027	98
03252	276	03590	207	04011/PC72	259	04201	222	27027*	40
03253	276	03590	211	04011/PC90	259	04201	229	27027*	56
03256	276	03590	221	04011/WC63	259	04201/P	230	27027*	75
03341	232	03590	226	04011/WC72	259	04206	202	27027*	98
03342	232	03590	232	04011/WC78	259	04206	206	27027*	105
03343	232	03591	201	04012/BL	260	04206	209	27028	36
03346	232	03591	207	04012/OB72	260	04206	216	27029*	40
03401	280	03591	211	04012/OB90	260	04206	222	27029*	48
03402	280	03591	221	04012/PC55	260	04206	229	27029*	56
03403	280	03591	226	04012/PC72	260	04206/P	230	27029*	75
03406	280	03591	232	04012/PC90	260	04207	202	27029*	76
03411/C	284	03591	279	04012/PC92	260	04207	206	27029*	105
03412/C	284	03592	201	04012/WC63	260	04207	209	27031	84
03413/C	284	03592	207	04012/WC72	260	04207	216	27080*	40
03416/C	284	03592	211	04012/WC90	260	04207	222	27080*	48
03441	285	03592	221	04015/BL	260	04207	229	27080*	105
03442	285	03592	226	04015/PC72	260	04207/P	230	27081*	40
03443	285	03592	232	04051	227	04212P/T8	230	27081*	105
03446	285	03592	279	04051/P	228	04212P/T67	230	27084	40
03461	277	03594	201	04052	227	04212/T8	202	27084	48
03462	277	03594	207	04052/P	228	04212/T8	206	27084	56
03463	277	03594	211	04053	227	04212/T8	209	27084	75
03466	277	03594	221	04053/P	228	04212/T8	216	27084	76

Index

27084	105	91050G01.688	63	91451R07.X8*	93	93114	98	93214	317
27221	72	91050G01U.ZN	328	91451R07.X9*	93	93115	98	93214	329
27224	72	91050G01.X8	63	91455R07.X8*	92	93116	48	93234-70	40
27225	72	91050G02.28	62	91455R07.X9*	92	93116	98	93234-70	48
27227	72	91050G02.38	62	92045	117	93119*	48	93234-70	56
27228	72	91050G02.58	62	92065/BL	261	93120*	40	93234-70	75
67102/R	234	91050G02.688	62	92065/OB56	261	93120*	56	93234-70	76
67102/R	319	91050G02.U8	62	92065/OB72	261	93120*	75	93234-70	105
80001	369	91050G02.U8	63	92065/OB90	261	93120*	84	93234-80	40
80003	369	91050G02.X8	62	92065/OB110	261	93120*	105	93234-80	48
80005	370	91050R06.39	44	92065/PC55	261	93120-160	40	93234-80	56
80006	371	91050R06.U9	44	92065/PC72	261	93120-160	56	93234-80	75
80007	370	91050R06.X9	44	92065/PC90	261	93120-160	75	93234-80	76
80107	365	91070F72.39	47	92065/PC92	261	93120-160	105	93234-80	105
80108	366	91070F72.U9	47	92065/WC63	261	93123	84	93234-90	40
80111	365	91070G01.28	71	92065/WC72	261	93123*	40	93234-90	48
80112	365	91070G01.38	71	92065/WC78	261	93123*	56	93234-90	56
80113	365	91070G01.58	71	92065/WC90	261	93123*	75	93234-90	75
80114	365	91070G01.688	71	92065/WC116	261	93124*	48	93234-90	76
80131/L	366	91070G01U.ZN	329	92066/BL	261	93127	40	93234-90	105
80131/R	366	91070G01.X8	71	92066/PC72	261	93127	56	93234-100	40
80132/L	366	91070G02.28	70	92450	97	93127	75	93234-100	48
80132/R	366	91070G02.38	70	92450	299	93129	40	93234-100	56
80133/L	366	91070G02.58	70	92450	325	93129	56	93234-100	75
80133/R	366	91070G02.688	70	92451	97	93129	75	93234-100	76
80134/L	366	91070G02.U8	70	92451	299	93129	98	93234-100	105
80134/R	366	91070G02.U8	71	92451	325	93130	48	93235	235
80141	364	91070G02.X8	70	92452	97	93130	76	93239-50	84
80142	364	91070R06.39	46	92452	299	93130	98	93244	372
80143	364	91070R06.U9	46	92452	325	93142*	76	93245	330
80144	364	91070R06.X9	46	92455	97	93145	76	93246	330
80180	373	91098G01.28	61	92455	299	93156	309	93247	330
80181	373	91098G01.38	61	92455	325	93156*	76	93248	372
80183	373	91098G01.58	61	92460	97	93166	305	93274	330
80184	373	91098G01.688	61	92460	299	93166	309	93275	330
80185	375	91098G01.X8	61	92460	325	93166	313	93283	331
80186	375	91098G02.28	60	92461	97	93166	317	93290	322
80187	374	91098G02.38	60	92461	299	93166	329	93291	321
80188	374	91098G02.58	60	92461	325	93167	305	93301	332
80190	367	91098G02.688	60	92462	97	93167	309	93303	332
80191	368	91098G02.U8	60	92462	299	93167	313	93304	333
80195	368	91098G02.U8	61	92462	325	93167	317	93419/35	366
91023G01.28	69	91098G02.X8	60	93020	335	93167	329	93421/35	365
91023G01.38	69	91099G01.28	65	93021	335	93168	305	93423	331
91023G01.58	69	91099G01.38	65	93022	335	93168	309	93426	331
91023G01.688	69	91099G01.58	65	93023	335	93168	313	93542/R35	390
91023G01.X8	69	91099G01.688	65	93024	335	93168	317	93542/R35	390
91023G02.28	68	91099G01.X8	65	93025	335	93168	329	93542/R35	390
91023G02.38	68	91099G02.28	64	93026	335	93173	321	93542/R35	390
91023G02.58	68	91099G02.38	64	93027	335	93173	322	93566	334
91023G02.688	68	91099G02.58	64	93028	335	93174	321	93567	334
91023G02.U8	68	91099G02.688	64	93029	335	93174	322	93569	336
91023G02.U8	69	91099G02.U8	64	93030	335	93175	321	93600	72
91023G02.X8	68	91099G02.U8	65	93031	335	93175	322	93600	75
91030G01.28	67	91099G02.X8	64	93032	335	93176	321	93600	76
91030G01.38	67	91310	254	93107	40	93176	322	94100PL	133
91030G01.58	67	91311	254	93107	48	93180*	48	94100PR	133
91030G01.688	67	91380	96	93107	56	93180*	76	94101	133
91030G01U.ZN	328	91381	96	93107	75	93180*	98	94102	133
91030G01.X8	67	91382	96	93107	76	93185	98	94103	133
91030G02.28	66	91383	96	93107	105	93186	98	94104	133
91030G02.38	66	91393R07.X8*	88	93108	235	93202	76	94110PL	135
91030G02.58	66	91401R07.X8*	95	93109	76	93202	309	94110PR	135
91030G02.688	66	91401R07.X9*	95	93111	40	93206/2	254	94111	135
91030G02.U8	66	91411R07.X8*	91	93111	56	93213	305	94112	135
91030G02.U8	67	91411R07.X9*	91	93111	75	93213	309	94114	135
91030G02.X8	66	91431R07.X8*	90	93111	84	93213	313	94120PL	134
91050F72.39	45	91431R07.X9*	90	93111	98	93213	317	94120PR	134
91050F72.U9	45	91435R07.X8*	89	93111	105	93213	329	94121	134
91050G01.28	63	91435R07.X9*	89	93111	317	93214	305	94122	134
91050G01.38	63	91441R07.X8*	94	93112	98	93214	309	94123	134
91050G01.58	63	91441R07.X9*	94	93113	98	93214	313	94124	134

Index

94130	136	97011	251	98004	83	EN91030R05.68H1	16	EN91070B72.98	30
94131	136	97011	251	98005	83	EN91030R05.88	17	EN91070B72.688	30
94132	136	97100	267	98009	82	EN91030R05.98	17	EN91070K00.58	31
94135	137	97101	267	98010	82	EN91030R05.681	16	EN91070K55.38	31
94136	137	97102	267	0101002-3U	80	EN91030R05.688	16	EN91070K56.28	31
94137	137	97103	267	0101002-X	80	EN91030R05.881	17	EN91070K72.38	31
94140	143	97104	269	0101006-3U	81	EN91030R05.882	17	EN91070K72.38	31
94160	138	97105	270	0101006-X	81	EN91030R05.883	17	EN91070K72.88	31
94162ES	138	97106	268	1001003-23	253	EN91030R05.981	17	EN91070K72.98	31
94162PS	138	97107	268	1001003-23	253	EN91030R05.982	17	EN91070K72.688	31
94163ES	138	97108	271	1001003-68	253	EN91030R05.983	17	EN91070R05.28	28
94163PS	138	97109L	270	1001003-X	253	EN91030R05.X8	16	EN91070R05.38	28
94165	138	97109R	270	1001005-23	252	EN91050B00.58	26	EN91070R05.58	28
94167PS	138	97110	266	1001005-23	252	EN91050B00.88	26	EN91070R05.68H	28
94168PS	138	97111	266	1001005-68	252	EN91050B00.98	26	EN91070R05.68H1	28
94171	139	97112	266	1001005-X	252	EN91050B55.38	26	EN91070R05.88	29
94172ES	138	97113	266	1001009-23	247	EN91050B56.28	26	EN91070R05.98	29
94175	139	97114	269	1001009-23	247	EN91050B72.28	26	EN91070R05.681	28
94183ES	138	97115	270	1001009-68	247	EN91050B72.38	26	EN91070R05.688	28
94205	141	97116	268	1001009-X	247	EN91050B72.88	26	EN91070R05.881	29
94215	140	97117	268	1002040-23	249	EN91050B72.98	26	EN91070R05.882	29
94216	140	97118	76	1002040-23	249	EN91050B72.681	26	EN91070R05.883	29
94220	140	97118	271	1002040-68	249	EN91050B72.688	26	EN91070R05.981	29
94221	140	97119L	270	1002040-X	249	EN91050BV00.58	104	EN91070R05.982	29
94225	141	97119R	270	1002041-23	251	EN91050BV72.38	104	EN91070R05.983	29
94230	142	97120	266	1002041-23	251	EN91050BV72.681	104	EN91070R05.X8	28
94235	142	97121	266	1002041-68	251	EN91050C00.58	53	EN91078R05.28	32
94250	144	97122	266	1002041-X	251	EN91050C00.88	53	EN91078R05.38	32
94260	144	97123	267	1002043-23	250	EN91050C00.98	53	EN91078R05.58	32
94270	145	97124	267	1002043-23	250	EN91050C72.38	53	EN91078R05.68H	32
94272	145	97125	267	1002043-68	250	EN91050C72.88	53	EN91078R05.68H1	32
94280	143	97126	269	1002043-X	250	EN91050C72.98	53	EN91078R05.88	33
94910	333	97127	269	1002044-23	248	EN91050C72.688	53	EN91078R05.98	33
94911	333	97128	269	1002044-23	248	EN91050K00.58	27	EN91078R05.681	32
96010	257	97129	269	1002044-68	248	EN91050K55.38	27	EN91078R05.688	32
96010	258	97130	269	1002044-X	248	EN91050K56.28	27	EN91078R05.881	33
96010	259	97131	269	CU27025	125	EN91050K72.38	27	EN91078R05.882	33
96010	260	97132	270	CU91050R05.X8	125	EN91050K72.38	27	EN91078R05.883	33
96010	261	97133	270	CU96140	125	EN91050K72.88	27	EN91078R05.981	33
96011	257	97134	268	CUR05.6X8	125	EN91050K72.98	27	EN91078R05.982	33
96011	258	97135	268	EN91029R05.88	18	EN91050K72.688	27	EN91078R05.983	33
96011	259	97717	76	EN91029R05.98	18	EN91050KV00.58	103	EN91078R05.X8	32
96011	260	97722	36	EN91029R05.X8	18	EN91050KV72.38	103	EN97719R05.28	34
96011	261	97722/1	36	EN91030B00.58	20	EN91050KV72.681	103	EN97719R05.38	34
96140	73	97722/1	102	EN91030B00.88	20	EN91050R05.28	22	EN97719R05.58	34
96141	73	97755	39	EN91030B00.98	20	EN91050R05.38	22	EN97719R05.68H	34
96141/2	74	97756	37	EN91030B55.38	20	EN91050R05.58	22	EN97719R05.68H1	34
96142	73	97802	37	EN91030B56.28	20	EN91050R05.68H	22	EN97719R05.88	35
96143	73	97803	37	EN91030B72.28	20	EN91050R05.68H1	22	EN97719R05.98	35
96143/2	74	97804	39	EN91030B72.38	20	EN91050R05.88	23	EN97719R05.681	34
96144	73	97805	39	EN91030B72.88	20	EN91050R05.98	23	EN97719R05.688	34
96145	73	97806	39	EN91030B72.98	20	EN91050R05.681	22	EN97719R05.881	35
96162	37	97807	38	EN91030B72.688	20	EN91050R05.688	22	EN97719R05.882	35
96163	37	97808	38	EN91030C00.58	52	EN91050R05.881	23	EN97719R05.883	35
96164	37	97809	38	EN91030C00.88	52	EN91050R05.882	23	EN97719R05.981	35
96165	37	97810	39	EN91030C00.98	52	EN91050R05.883	23	EN97719R05.982	35
96181/R	234	97814	39	EN91030C72.38	52	EN91050R05.981	23	EN97719R05.983	35
96181/R	319	97815	38	EN91030C72.88	52	EN91050R05.982	23	EN97719R05.X8	34
96183/R	234	97819	38	EN91030C72.98	52	EN91050R05.983	23	ES92349	322
96183/R	319	97820	38	EN91030C72.688	52	EN91050R05.X8	22	ES92349	322
97001	247	97821	39	EN91030K00.58	21	EN91050RV05.X8	102	ES92351	321
97001	247	97822	39	EN91030K55.38	21	EN91055R05.88	24	ES92351	321
97001	252	97823	38	EN91030K56.28	21	EN91055R05.98	24	L0381	157
97001	252	97830	38	EN91030K72.28	21	EN91055R05.X8	24	L0381	161
97001	253	97832	54	EN91030K72.38	21	EN91070B00.58	30	L0381	163
97001	253	97833	54	EN91030K72.88	21	EN91070B00.88	30	L0381	164
97011	248	97835	55	EN91030K72.98	21	EN91070B00.98	30	L0381	165
97011	248	97836	55	EN91030K72.688	21	EN91070B55.38	30	L0381	166
97011	249	97837	54	EN91030R05.28	16	EN91070B56.28	30	L0381	167
97011	249	97838	54	EN91030R05.38	16	EN91070B72.28	30	L0382	157
97011	250	98001	83	EN91030R05.58	16	EN91070B72.38	30	L0382	161
97011	250	98002	83	EN91030R05.68H	16	EN91070B72.88	30	L0382	163

Index

L0382	164	L5041	155	LE73.2	172	W01	240
L0382	165	L5042	155	LE73.2	178	W01	241
L0382	166	L5043	155	LE73.3	172	W01	242
L0382	167	L5046	155	LE73.3	178	W01	243
L0383-T3	157	L5051	156	LE73.68	172	W02	239
L0383-T3	161	L5052	156	LE73.68	178	W02	240
L0383-T3	163	L5053	156	LE73.667	172	W02	241
L0383-T3	164	L5056	156	LE73.667	178	W02	242
L0383-T3	165	L5061	160	LE74.2	171	W02	243
L0383-T3	166	L5062	160	LE74.2	177	W03-T8	239
L0383-T3	167	L5063	160	LE74.3	171	W03-T8	240
L0501	154	L5066	160	LE74.3	177	W03-T8	241
L0501	155	L5071	162	LE74.66	171	W03-T8	242
L0501	158	L5072	162	LE74.66	177	W03-T8	243
L0502	154	L5073	162	LE74.67	171	W03-T8RG	239
L0502	155	L5076	162	LE74.67	177	W03-T8RG	240
L0502	158	L81430Q74.08	174	LE74.68	171	W03-T8RG	241
L0503-T3	154	L81430Q74.28	174	LE74.68	177	W03-T8RG	242
L0503-T3	155	L81430Q74.38	174	LQ71.2	169	W03-T8RG	243
L0503-T3	158	L81430Q74.688	174	LQ71.2	175	W03-T67	239
L0511	156	L81440Q74.08	168	LQ71.3	169	W03-T67	240
L0511	159	L81440Q74.28	168	LQ71.3	175	W03-T67	241
L0512	156	L81440Q74.38	168	LQ71.68	169	W03-T67	242
L0512	159	L81440Q74.688	168	LQ71.68	175	W03-T67	243
L0513-T3	156	L81450Q71.08	169	LQ71.667	169	W0901	241
L0513-T3	159	L81450Q71.28	169	LQ71.667	175	W0902	241
L0521	160	L81450Q71.38	169	LQ74.2	168	W0903	241
L0521	162	L81450Q71.688	169	LQ74.2	174	W0906	241
L0522	160	L81500Q71.08	175	LQ74.3	168	W1001	239
L0522	162	L81500Q71.28	175	LQ74.3	174	W1002	239
L0523-T3	160	L81500Q71.38	175	LQ74.68	168	W1003	239
L0523-T3	162	L81500Q71.688	175	LQ74.68	174	W1006	239
L3821	165	L81510E71.08	179	LQ74.667	168	W1011	243
L3822	165	L81510E71.28	179	LQ74.667	174	W1012	243
L3823	165	L81510E71.38	179	LR74.2	170	W1013	243
L3826	165	L81510E71.688	179	LR74.2	176	W1016	243
L3831	166	L81520E74.08	177	LR74.3	170	W1031	240
L3832	166	L81520E74.28	177	LR74.3	176	W1032	240
L3833	166	L81520E74.38	177	LR74.66	170	W1033	240
L3836	166	L81520E74.688	177	LR74.66	176	W1036	240
L3841	167	L81520R74.08	176	LR74.67	170	W1051	242
L3842	167	L81520R74.28	176	LR74.67	176	W1052	242
L3843	167	L81520R74.38	176	LR74.67	176	W1053	242
L3846	167	L81520R74.688	176	LR74.68	170	W1056	242
L3851	164	L81520R74.688	176	LR74.68	176		
L3852	164	L81530E73.08	178	PK3946 + 93156	317		
L3853	164	L81530E73.28	178	PK5766 + 93156-140	317		
L3853	164	L81530E73.38	178	PK8491 + 97717	317		
L3856	164	L81530E73.688	178	PW3946	317		
L3861	161	L81610E74.08	171	PW5766	317		
L3862	161	L81610E74.28	171	PW8491	317		
L3863	161	L81610E74.38	171	R05.6X8	36		
L3866	161	L81610E74.688	171	R05.6x8/1	102		
L3871	163	L81610R74.08	170	R05.6X8/1	36		
L3872	163	L81610R74.28	170	S02.68	247		
L3873	163	L81610R74.38	170	S02.68	252		
L3876	163	L81610R74.688	170	S02.68	253		
L3981	157	L81620E73.08	172	S02.667	247		
L3982	157	L81620E73.28	172	S02.667	252		
L3983	157	L81620E73.38	172	S02.667	253		
L3986	157	L81620E73.688	172	S12.68	248		
L5011	158	L81650E71.08	173	S12.68	249		
L5012	158	L81650E71.28	173	S12.68	250		
L5013	158	L81650E71.38	173	S12.68	251		
L5016	158	L81650E71.688	173	S12.667	248		
L5021	159	LE71.2	173	S12.667	249		
L5022	159	LE71.2	179	S12.667	250		
L5023	159	LE71.3	173	S12.667	251		
L5026	159	LE71.3	179	TK5766 + 97717	309		
L5031	154	LE71.68	173	TW70	309		
L5032	154	LE71.68	179	TW80	309		
L5033	154	LE71.667	173	TW5766	309		
L5036	154	LE71.667	179	W01	239		