



ALEX

Fabricantes desde 1958



CATÁLOGO de RUEDAS

32

www.alex.es



CATÁLOGO GENERAL RUEDAS ALEX

RUEDAS ALEX S.L.U.

c/ Comunidad Castilla y León, s/n
Plataforma Logística de Fraga
22520 Fraga (Huesca) España

T.: 974 035 345

OFICINAS COMERCIALES

T.: Madrid

913 553 875

T.: Barcelona

936 828 020

ventas@alex.es

www.alex.es



© Copyright RUEDAS ALEX S.L.U. 2022

La reproducción total o parcial de este catálogo está totalmente prohibida sin el consentimiento previo por escrito de Ruedas Alex S.L.U.



ALEX

Fabricantes desde 1958



32

CATÁLOGO
de
de
RUEDAS

MOVING INDUSTRY FORWARD

www.alex.es



Guía técnica	10
Guía para fijaciones	21
Alta capacidad de carga	
SERIE HLR > Hasta 6.000 kg. de carga por rueda	40
SERIE HLG > Hasta 2.600 kg. de carga por rueda	42
SERIE HLB > Hasta 2.750 kg. de carga por rueda	46
SERIE HLS > Hasta 1.250 kg. de carga por rueda	52
SERIE HLSB > Hasta 1.000 kg. de carga por rueda	56
SERIE GT > Hasta 1.270 kg. de carga por rueda	62
SERIE FM > Hasta 1.500 kg. de carga por rueda	66
Accesorios y usos especiales (Serie JA / Frenos)	68
Alta y media capacidad de carga	
SERIE SLR > Hasta 1.000 kg. de carga por rueda	72
SERIE SL > Hasta 600 kg. de carga por rueda	80
SERIE TV > Hasta 800 kg. de carga por rueda	84
SERIE TVC > Hasta 280 kg. de carga por rueda	94
SERIE ZVR > Hasta 700 kg. de carga por rueda	98
SERIE ZV > Hasta 450 kg. de carga por rueda	106
SERIE 61 > Hasta 475 kg. de carga por rueda	138
SERIE LP > Hasta 600 kg. de carga por rueda	142
Andamios y construcción	
SERIE TVA > Hasta 700 kg. de carga por rueda	146
SERIE TC > Hasta 400 kg. de carga por rueda	148
SERIE ZVA > Hasta 350 kg. de carga por rueda	150
Acero inoxidable	
SERIE ZVI > Hasta 600 kg. de carga por rueda	154
SERIE ZLI > Hasta 130 kg. de carga por rueda	172
SERIE BHI > Hasta 80 kg. de carga por rueda	176
Colectividades, hostelería, mobiliario clínico	
SERIE A > Hasta 125 kg. de carga por rueda	182
SERIE BHA > Hasta 100 kg. de carga por rueda	188
SERIE HC > Hasta 100 kg. de carga por rueda	192
SERIE HD > Hasta 125 kg. de carga por rueda	194
SERIE AN > Hasta 100 kg. de carga por rueda	196
SERIE HP > Hasta 40 kg. de carga por rueda	198
SERIE M > Hasta 90 kg. de carga por rueda	202
SERIE BH > Hasta 80 kg. de carga por rueda	204
SERIE IG > Hasta 100 kg. de carga por rueda	210
SERIE I > Hasta 100 kg. de carga por rueda	212
Fijaciones para soportes	215

Muebles auxiliares

SERIE HP > Hasta 30 kg. de carga por rueda	218
SERIE IB > Hasta 50 kg. de carga por rueda	222
SERIE BD > Hasta 40 kg. de carga por rueda	224
SERIE B > Hasta 40 kg. de carga por rueda	230
SERIE H > Hasta 22 kg. de carga por rueda	234
SERIE Z > Hasta 60 kg. de carga por rueda	236
SERIE N > Hasta 60 kg. de carga por rueda	238
SERIE DK > Hasta 60 kg. de carga por rueda	242
SERIE DKG > Hasta 120 kg. de carga por rueda	245
Fixalenes	246

Neumáticas

SERIE ZV > Hasta 75 kg. de carga por rueda	248
SERIE WL > Hasta 220 kg. de carga por rueda	252
SERIE HLBI > Hasta 300 kg. de carga por rueda	256

Decoración

SERIE ALU > Hasta 50 kg. de carga por rueda	260
SERIE BDM > Hasta 50 kg. de carga por rueda	260
SERIE CLR > Hasta 40 kg. de carga por rueda	261
SERIE BDT > Hasta 60 kg. de carga por rueda	261
SERIE RD > Hasta 40 kg. de carga por rueda	262
SERIE MDC > Hasta 50 kg. de carga por rueda	263
SERIE BH > Hasta 80 kg. de carga por rueda	264
SERIE BLS > Hasta 40 kg. de carga por rueda	265
SERIE BLC > Hasta 40 kg. de carga por rueda	265
SERIE DKP > Hasta 80 kg. de carga por rueda	266
SERIE DKM > Hasta 80 kg. de carga por rueda	267

Aros y rodillos RECAMBIOS

Aros de goma	270
Aros de poliuretano	278
Aros de nylon	284
Aros de poliamix	286
Aros de acero y resina	288
Otros aros	290
Rodillos para transpaletas	292

Twin-Lex

SERIE 110 a 805	296 - 321
Índice de referencias	322





Colaboración integral con el cliente

Nuestra filosofía de empresa es generar un marco de colaboración con el cliente y convertirnos en su socio, con el fin de ayudarle a consolidar el desarrollo de su negocio. Ruedas Alex se ha caracterizado permanentemente por la flexibilidad y adaptación de sus productos a las necesidades de nuestros clientes, intentando crear el máximo valor para los mismos.

Gracias a esta relación de confianza, Ruedas Alex ha podido desarrollar la gama de ruedas más extensa de España y nuestros clientes se convierten directamente en nuestros socios y máximos colaboradores, ya que son ellos los encargados de transmitir nuestra calidad y prestigio al usuario final.

Una empresa con historia

Ruedas Alex inició su actividad en el año 1953 fabricando aparatos de precisión, pero no fue hasta 1958 cuando comenzó a fabricar ruedas para manutención. Desde sus orígenes en un pequeño taller en la ciudad de Barcelona, y gracias a su enorme esfuerzo y dedicación a lo largo de todos estos años, Ruedas Alex no sólo se convirtió en una empresa consolidada, sino la empresa líder en ruedas autorientables en España.

Innovación, investigación y desarrollo

Nuestro departamento de I+D+i desarrolla la rueda idónea adaptada a cada necesidad y tipo de aplicación de nuestros clientes. Para ello y junto con su colaboración, nuestros ingenieros cuentan con la más moderna tecnología y programas de dibujo en 2 y 3D.

Productividad y automatismo

En Ruedas Alex fabricamos miles de ruedas en series medianas, grandes, y piezas únicas gracias a un alto grado de automatización, conseguido con unas máquinas de primer nivel que nos permiten obtener ruedas de calidad en un corto espacio de tiempo.

La gran capacidad, flexibilidad y agilidad de nuestro sistema productivo, conjugando de manera sobresaliente, calidad, precio y plazos de entrega, nos posibilita gestionar pedidos de gran volumen de una forma rápida y eficaz.



Calidad y servicio

Ruedas Alex se caracteriza por un magnífico servicio destinado a satisfacer por completo las necesidades de los clientes. Disponemos de un servicio inmediato de Atención al Cliente para ofertas y consultas de pedidos y un servicio de Entrega Express que prepara los pedidos y los entrega en las plataformas de las agencias de transporte en 24 horas.

Todo esto hace que Ruedas Alex tenga una concepción integrada y sistemática de la calidad, lo que nos permite avanzar hacia la consideración de la calidad como un objetivo global de toda la empresa.

Prestigio internacional

Una de nuestras mayores metas en la actualidad es conseguir exportar fielmente todos los valores que nos definen como una de las marcas de ruedas de mayor prestigio a nivel Español. Distribuimos nuestros productos en más de 50 países, teniendo una gran aceptación en los mercados más exigentes y siendo el área internacional uno de los de mayor crecimiento en los últimos años.



Cómo buscar, encontrar y seleccionar una rueda industrial de manera fácil, rápida y en un solo lugar?

En Ruedas Alex, sabemos cómo ayudarte!. Entra y visita nuestra página web www.alex.es donde encontrarás un **multibuscador inteligente** donde hemos tratado de incorporar un algoritmo de búsqueda contextual inteligente, mejorando su eficiencia y facilitándote la tarea de manera rápida y con total fiabilidad.

También disponemos de otros buscadores como es el **buscador avanzado**, donde permite afinar una búsqueda, reduciéndola al máximo, gracias a filtros prácticos y técnicos o si se prefiere realizar una búsqueda por sectores, disponemos de nuestro **buscador por aplicaciones**.

Otra de las características a destacar de esta web, es la posibilidad de **descargarte** todas las **fichas técnicas (planos en PDF)**, dibujos de todas nuestras ruedas en formato **3D** o nuestro **servicio CAD** para los proyectos e ingenieros que las requieran.

La web permite navegar por ella rápidamente con el menú de productos siempre visible y muy fácil de usar.

Conócenos con tan solo un click!

DESCARGA DE FICHAS TÉCNICAS

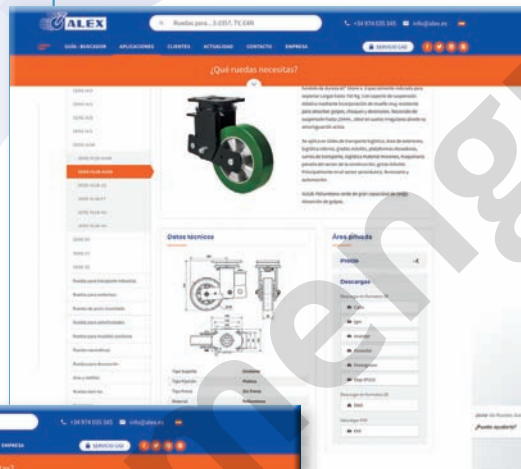

SERVICIO CAD

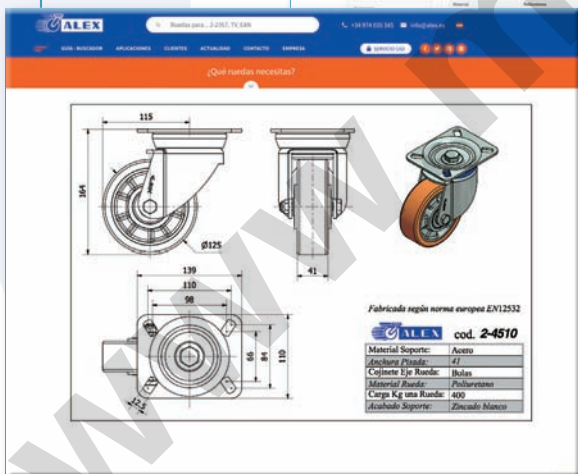

MULTIBUSCADOR INTELIGENTE

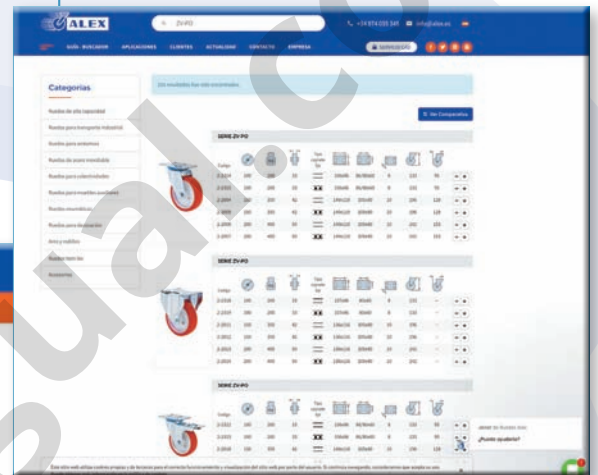

CHAT ONLINE

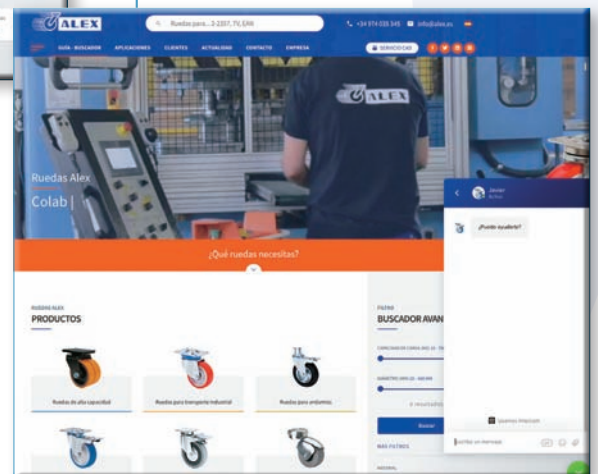

CONÓCENOS CON TAN SOLO UN CLICK

www.alex.es





Factores para la elección de una rueda

Capacidad de carga

Con el fin de poder determinar la rueda correcta para cada necesidad, se debe tener en cuenta la carga en vacío del propio aparato, la carga máxima que queremos transportar, así como el número de ruedas que soportarán dicha carga.

Debemos tener en cuenta también, que las capacidades de carga pueden variar según el tipo y condiciones de trabajo, así como que en superficies y en suelos desnivelados se pueden sobrecargar tres de las cuatro ruedas que habrían de soportar toda la carga.

Por lo tanto, por condiciones normales se ha de entender las que no tienen sobrecarga, no reciben golpes y que ruedan por un suelo liso, sin grietas, canales, guías de puertas, railes, etc, siendo el suelo de naturaleza no abrasiva.

La siguiente formula facilitará conocer la capacidad de carga necesaria:

$$C = \frac{P+M \times S}{N}$$

C: capacidad de carga requerida para cada rueda

P: peso propio del aparato de transporte

M: carga máxima

N: número de ruedas aplicadas

S: factor de seguridad

El "factor S" hace referencia a las variaciones en relación a las condiciones normales de uso. Hay que utilizar este factor de seguridad "S" que va de un valor entre 1,3 y 2,0 para poder establecer la capacidad de carga.

Todas las capacidades de carga indicadas en este catálogo han sido determinadas de acuerdo a las normas europeas de manutención EN 12528 a EN 12533.



Tipos de cojinete

Cojinete Liso

Es la forma más sencilla, con buje de taladro liso. Son habituales en ruedas domesticas y ruedas de transporte cuando se han de hacer movimientos a baja velocidad y a distancias cortas. Son resistentes a los golpes, a la corrosión y habitualmente no necesitan mantenimiento, aunque es recomendable un engrase periódico.

Cojinete de bolas

Se compone de bolas endurecidas que están sobre una guía: uno exterior y otro interior. Es ideal para ruedas con mayores exigencias de trabajo, donde prima la facilidad de desplazamiento. Tiene un rozamiento por fricción mínimo. Al ser estanco, retiene la grasa y no permite la entrada de suciedad.

Cojinete de rodillos

Se compone de rodillos de acero que están alojados en una jaula de acero o plástico. Son idóneos para transporte debido a su mínima resistencia a la rodadura y su buen comportamiento con carga. El cojinete va engrasado y no es necesario engrasarlo de nuevo salvo si se utiliza para grandes cargas.

Cojinete cónico

Son los rodamientos más robustos y la más adecuada para cargas extrapesadas o usos muy intensivos. Se montan 2 por rueda en posición invertida uno frente a otro. El Coeficiente de fricción es mayor que los rodamientos de bolas o rodillos. Se aconseja lubricación periódica.



Fijaciones

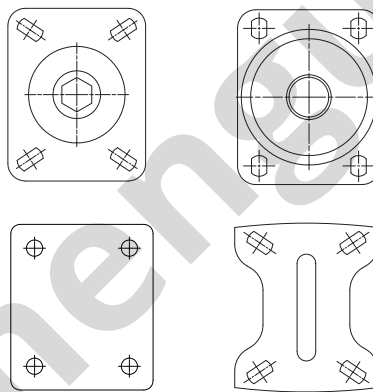

Fijación por placas atornillables:

Son las más idóneas cuando la base del aparato, máquina, equipo donde se sustentan es plana. Se utiliza para ruedas domesticas, transporte industrial y alta carga. Las dimensiones están normalizadas y son proporcionales al diámetro de la rueda.

La medida más extendida entre agujeros es de 80x60mm con un diámetro de 80 a 100. A partir de un diámetro de 125mm lo más habitual es 105x80. Existen medidas mayores que se utilizan para cargas extrapesadas.

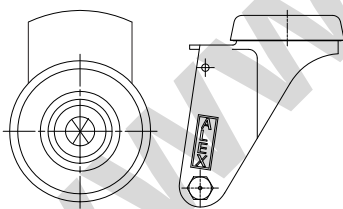

Fijación por agujero pasante:

Consiste en un agujero central en el cojinete de la horquilla, en el cual se introduce un tornillo, que suele ir desde M8 hasta M12.

La capacidad de carga varía en función de la fijación. Su uso más habitual es en aparatos o elementos donde no se exige una capacidad de carga elevada.

Destaca por su facilidad de montaje.

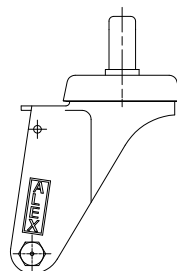

Fijación por espiga de acero con taco:

La espiga es introducida directamente en el tubo junto al taco seleccionado. Se utiliza para ruedas domésticas y para aparatos de transporte: percheros, expositores, jardineras, mesas de televisión.

Existen gran variedad de medidas de tacos de plástico para los diferentes agujeros de tubo donde van alojados, tanto circular como cuadrado.

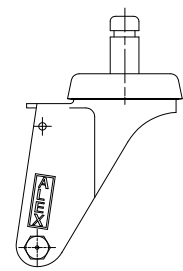

Fijación por espiga de acero lisa con anilla:

Es introducido directamente en un tubo. Posee una anilla en su parte superior para una mejor fijación y sujeción en el alojamiento.

Destaca por su facilidad de montaje. Son usadas principalmente en sillas de despacho.

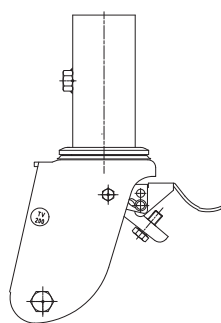

Fijación para andamio espiga cazoleta

El tubo del andamio se introduce dentro de la espiga de la rueda y queda fijada mediante un tornillo de apriete.

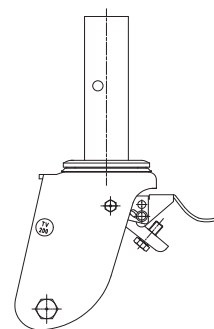

Fijación para andamio espiga sólida

La espiga de la rueda se introduce dentro del tubo del andamio y queda fijada mediante un pasador.

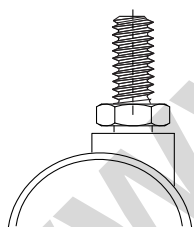

Fijación por espiga roscada:

El aparato tiene una rosca cilíndrica para poder fijar la rueda.

La espiga roscada se aprieta o enrosca con una tuerca. Dentro del ámbito doméstico, es la clase de fijación más utilizada junto con la platina.

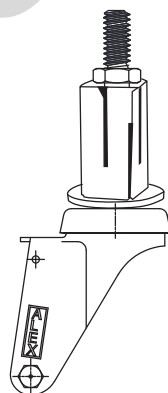

Fijación con expansivo de plástico:

Está compuesto por un tornillo, dos elementos cónicos y una pieza de plástico expansible.

La pieza de plástico se expande en el interior del tubo al enroskar el tornillo. Su uso más común es en el ámbito hospitalario e institucional.

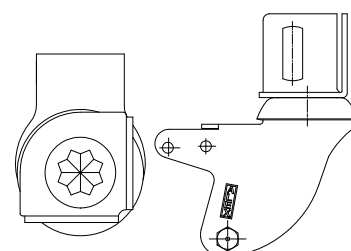

Fijación por ángulo ranurado:

Están diseñadas especialmente para el montaje de estanterías modulares.

Disponibles en 3 diámetros distintos: 40 , 60 y 80.



Resistencia Química

- 1.- Alta capacidad de resistencia
- 2.- Mediana capacidad de resistencia
- 3.- Baja capacidad de resistencia

Material	Concentración %	Goma	Nylon	Poliuretano	Polipropileno	Resina	Acero
Aceite de Coco	-	3	1	1	-	-	-
Aceite de la Semilla de Algodón	-	-	-	1	-	-	-
Aceites Minerales	-	3	1	1	-	1	1
Aceite de terpentina	-	3	1	2	3	-	-
Aceites Vegetales	-	3	1	1	-	-	-
Acetaldehído	40%	2	2	3	2	-	-
Acetato Amílico	-	1	1	3	1	-	-
Acetato de Aluminio	-	-	1	-	-	-	-
Acetato de Plomo, Acuoso	10%	2	1	1	3	-	-
Acetileno	-	1	1	1	-	-	-
Acetona	-	1	1	3	2	1	1
Ácido Acético Puro	-	2	-	3	1	1	3
Ácido Acrílico	-	-	3	3	-	-	-
Ácido Bórico, Acuoso	10%	1	2	1	2	-	-
Ácido Carbónico	-	-	-	1	-	-	-
Ácido Cítrico Acuoso	10%	1	1	-	-	-	-

Material	Concentración %	Goma	Nylon	Poliuretano	Polipropileno	Resina	Acero
Ácido Clorhídrico Acuoso	30%	2	3	3	1	-	-
Ácido de Cobalto, Acuoso	20%	-	2	-	-	-	-
Ácido Nitrohidroclórico	-	3	3	3	3	1	3
Ácido Crómico, Acuoso	10%	3	2	2	3	-	-
Ácido de Tanina	10%	1	-	-	-	-	-
Ácido Fórmico	10%	2	3	3	1	-	-
Ácido Fosfórico Acuoso	10%	2	3	-	1	1	3
Ácido Oleico	-	3	1	1	-	-	-
Ácido Oxálico Acuoso	10%	-	2	-	1	-	-
Ácido Palmítico	-	3	1	3	-	-	-
Ácido Sulfúrico	-	2	2	3	1	1	3
Ácido Tartárico Acuoso	10%	1	1	2	-	-	-
Ácido Úrico Acuoso	10%	1	1	-	-	-	-
Ácidos Grasos	-	3	1	1	-	-	-
Ácidos Lácticos	-	3	3	3	1	-	-
Agua de Mar	-	1	1	2	-	1	1
Agua Fría	-	1	1	1	-	1	1
Agua, hasta 80%	-	2	1	3	-	-	-
Aguas Residuales	-	-	1	2	-	-	-
Alcohol Amílico	-	1	1	2	1	-	-
Alcohol Etilico	-	1	2	1	1	-	-
Alcohol Metílico	-	2	2	1	1	-	-
Alcohol Propílico	-	-	-	2	-	-	-
Aminoácido-Mezcla	-	-	1	-	-	-	-
Amoniaco, Líquido	20%	1	1	3	1	3	1
Anilina	-	3	2	3	1	-	-
Antraquinona, 85%	-	-	1	-	-	-	-
Bencina, Éter de Petroleo	-	3	1	1	-	-	-
Betún	-	3	1	1	-	-	-
Bicarbonato de Amonio	-	-	1	-	-	-	-
Borax	-	1	-	1	-	-	-
Bromo	-	3	3	3	3	-	-
Butanol	-	3	1	1	-	-	1
Carbolíneo	-	3	1	3	-	-	-
Carbonato de Amonio	-	1	-	3	-	-	-
Carbonato de Sodio Acuoso	10%	-	1	3	1	-	-
Caseína	-	-	1	-	-	-	-
Cera, 80%	-	-	1	-	-	-	-
Cerveza	-	1	1	1	-	-	-
Cianuro de potasio	-	-	-	2	-	-	-
Cianuro de Sodio Acuoso	10%	-	1	3	-	-	-

Cuanto más se conozcan las condiciones ambientales en las que se utilizarán las ruedas, mejor podremos ajustarlas a estas condiciones existentes.

No obstante, la resistencia química de una rueda no sólo depende de la clase de sustancia con la que se esté en contacto, sino que también influyen otros factores como el tiempo de exposición, la concentración de esa sustancia, y otras condiciones ambientales como temperatura y humedad, entre otros.

Los valores indicados en la tabla sirven únicamente de orientación.

Material	Concentración %	Goma	Nylon	Poliuretano	Polipropileno	Resina	Acero
Ciclohexanol	-	2	1	2	-	-	-
Cloro, Agua de Cloro	-	3	3	3	3	-	-
Cloruro de Cinc, Acuoso	10%	1	2	3	1	-	-
Cloruro de Cobre	-	1	-	1	-	-	-
Cloruro de Hierro, Ácido	10%	2	3	2	1	-	-
Cloruro de Mercurio	-	-	3	1	1	-	-
Cloruro de Metileno	-	3	3	3	-	-	-
Cloruro de Níquel Acuoso	10%	1	2	1	-	-	-
Cloruro de Potasio	10%	2	1	1	1	-	-
Cloruro de Sodio Acuoso	10%	2	3	1	1	-	-
Cloruro de Vinilo, 80%	-	-	1	-	-	-	-
Descalcificadores Acuoso	10%	-	1	-	-	-	-
Diclorobutileno	-	3	-	3	-	-	-
Dicloroetileno	-	3	2	3	3	-	-
Dimetilaniлина	-	-	-	3	-	-	-
Dimetilformamida	-	2	1	3	1	-	-
Etanolamina	-	-	-	3	-	-	1
Etileno	-	-	-	1	-	-	-
Fenilbenceno	-	3	-	3	-	-	-
Fluoruros de Uranio	-	-	3	-	-	-	-
Fluor	-	3	3	3	3	-	-
Formaldehído	30%	1	1	2	1	-	-
Formamida Pura	-	1	1	2	-	-	-
Fosfato de Sodio Acuoso	10%	1	1	1	1	-	-
Gases de Humo	-	-	-	3	-	-	-
Gases Inertes	-	-	1	-	-	-	-
Gelatina	-	-	-	1	-	-	-
Glicerina	-	1	1	1	1	-	-
Glicol	-	1	2	2	1	-	-
Glucosa	-	1	-	1	-	-	-
Hexano	-	3	1	1	-	-	-
Hidróxido Amónico	-	-	-	3	-	-	-
Hidróxido de Potasio	-	-	1	3	1	-	-
Hidróxido de Sodio Acuoso	-	1	1	3	1	3	1
Leche	-	1	1	1	-	-	-
Lejía de lavado, 80°C	-	1	1	2	-	-	-
Líquidos Hidráulicos	-	3	1	3	-	-	-
Mantequilla	-	3	1	1	-	-	-
Mercurio	-	1	1	1	1	-	-
Metilacetona	-	3	1	3	1	-	-
Metilpirrolidona	-	-	-	3	-	-	-

Material	Concentración %	Goma	Nylon	Poliuretano	Polipropileno	Resina	Acero
Monobromobenceno	-	3	-	3	-	-	-
Monóxido de Carbono, Cal.	-	-	1	3	-	-	-
Morteros, Cemento, Cal	-	1	1	-	-	-	-
Mostaza	-	-	-	1	-	-	-
Naftalina	-	3	1	3	1	-	-
Nitrato de Amonio	-	2	-	1	1	-	-
Nitrato de Plata	-	2	-	1	1	-	-
Nitrato de Plomo	-	1	-	1	-	-	-
Nitrato de Sodio Acuoso	10%	1	1	1	1	-	-
Orina	-	1	1	-	-	-	-
Ozono	-	3	2	1	-	-	-
Parafina	-	3	1	1	-	3	3
Potasa Caustica	-	-	-	3	-	-	-
Propano	-	3	1	1	-	-	-
Rodanuro de Zinc	30%	-	3	-	-	-	-
Sal Común (Soluciones d.)	-	-	1	-	-	-	-
Sales Acuoso de Cobre	10%	-	3	1	-	-	-
Sales Acuoso de Magnesio	10%	-	1	1	1	-	-
Sales de Amoniaco	-	-	1	-	1	-	-
Sales de Níquel Acuoso	10%	-	2	1	-	-	-
Sales de Bario	-	1	2	1	1	-	-
Sales de Potasio	-	-	-	2	1	-	-
Sales Mangánicas	10%	-	2	-	-	-	-
Silicato de Sodio Acuoso	10%	1	1	2	-	-	-
Soda lye	50%	1	2	3	1	-	-
Solución de Soda acuosa	10%	1	1	-	-	-	-
Sosa Caústica	50%	-	-	3	-	-	-
Sulfato de Amonio	-	2	-	1	1	-	-
Sulfato de Cobre	-	2	2	1	1	-	-
Sulfato de Hierro	-	-	-	1	-	-	-
Sulfato de Níquel Acuoso	10%	2	2	1	-	-	-
Sulfato de Potasio	-	1	-	1	1	-	-
Sulfato de Sodio Acuoso	10%	1	1	1	-	-	-
Sulfuro de Sodio Acuoso	10%	2	1	2	-	-	-
Tetracloruro de Carbono	-	3	1	3	-	-	-
Tinta	-	1	1	1	-	-	-
Tintura de Iodo	-	1	3	3	1	-	-
Tiosulfato Sódico	10%	1	1	2	-	-	-
Tolueno	-	3	1	3	3	-	-
Vaselina	-	-	1	-	1	-	-
Xilol	-	3	1	3	3	-	-



Colocación de las ruedas

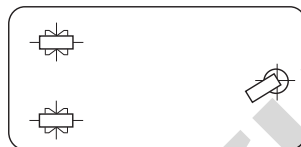

1 Rueda giratoria y 2 ruedas fijas:

Utilizar con cargas ligeras y cuando se requiera maniobrabilidad. El carro tiene que ser pequeño con la carga bien repartida. Máxima capacidad de carga = carga total/3.



4 Ruedas giratorias:

Buena capacidad de carga y maniobrabilidad. No utilizar en largos trayectos, con grandes cargas y suelos desiguales. Máxima capacidad de carga = carga total/3.



2 Ruedas giratorias y 2 ruedas fijas:

Uso Industrial. Buena capacidad de carga y maniobrabilidad incluso en largos trayectos. Máxima capacidad de carga = carga total/3.

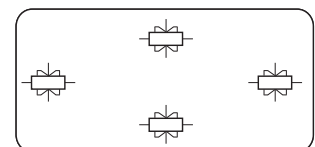

4 Ruedas fijas pivotantes centralmente:

Para cargas moderadas en largos trayectos rectos. Las ruedas fijas pueden sustituirse por ruedas sueltas montadas en un eje central. Máxima capacidad de carga = carga total/2.

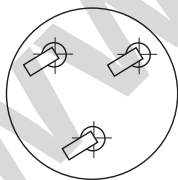

3 Ruedas giratorias:

Buena capacidad de carga y maniobrabilidad. Ideal para carros porta bidones y mover pequeña maquinaria. Máxima capacidad de carga = carga total/3.

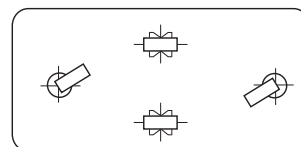

2 Ruedas giratorias y 2 ruedas fijas en el centro:

Buena capacidad de carga y maniobrabilidad en áreas pequeñas. Las ruedas centrales pueden ser sustituidas por ruedas montadas. Máxima capacidad de carga = carga total/2.

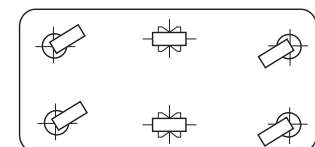

4 Ruedas giratorias y 2 ruedas fijas en el centro:

Para grandes carros que transportan grandes cargas. El carro ha de tener base robusta y pivotar sobre sus ruedas centrales. Máxima capacidad de carga = carga total/2.



Otros factores importantes

Resistencia a la rodadura:

Es la fuerza que debemos hacer para que el objeto esté en movimiento continuo y constante. Depende de factores como: diámetro de la rueda, condiciones climáticas, peso, tipo de bandaje, características del suelo y tipo de eje. Las ruedas de pisada blanda como la goma tienen mayor resistencia a la rodadura que una de pisada dura como el acero o nylon.

Ruidos de movimiento:

Las ruedas de pisada blanda como las de goma o poliuretano son silenciosas y no dañan el suelo, al contrario de las ruedas de pisada dura como las de acero que son más fuertes, resistentes y ruidosas.

Resistencia a la temperatura:

Para determinar este factor hemos de tener en cuenta la temperatura ambiente y el calor producido por el efecto de rodadura. La resistencia de una rueda se reduce considerablemente a temperaturas cercanas a los extremos establecidos en el rango de temperatura en el capítulo 2 (tipos de aro). Valores que son fijados en el catálogo de manera orientativa, ya que la resistencia depende de muchos otros factores. Para temperaturas muy elevadas, hay que elegir materiales especiales como resina o acero.

Influencias Climáticas:

Los cambios de temperatura y la humedad hacen que las ruedas se oxiden en poco tiempo. Para ruedas que están expuestas a ambientes extremos se recomienda utilizar un tipo de acabado pintado como la Serie HLB, HLG o en acero inoxidable como Serie ZVI.

Diámetro de la Rueda:

A mayor diámetro de la rueda menor resistencia a la rodadura. Las ruedas utilizadas como medio regular de transporte no deben ser inferiores a 100 mm. Las medidas más pequeñas se han de escoger en casos de baja movilidad y para pequeñas distancias con cargas ligeras.

Dificultad y distancia del recorrido:

Conociendo la distancia a recorrer y la dificultad del suelo, se puede recomendar el diámetro de la rueda. Cuantas más dificultades a vencer, se recomienda utilizar un mayor diámetro de rueda.

Tipo de Suelo:

Se recomienda utilizar ruedas de pisada dura para pisos planos, duros y regulares, goma elástica para suelos irregulares con obstáculos, poliuretano para pavimentos con aceites, grasas, virutas, cristales (suelos abrasivos), y ruedas neumáticas para suelos blandos o en malas condiciones.

Producto a transportar:

La fragilidad del producto a transportar puede condicionar la rueda a elegir. Generalmente los productos pueden ser trasladados con ruedas de banda dura. Para productos frágiles se recomiendan ruedas con bandaje blando.

Maniobrabilidad:

Es importante colocar las ruedas en la posición adecuada para que tengan la maniobrabilidad exigida para el tipo de trabajo o máquina que se esté utilizando:

-Largos trayectos: 2 ruedas giratorias + 2 ruedas fijas.

-Trayectos cortos con muchas maniobras: 4 ruedas giratorias

Prueba Efectiva:

Debido a la dificultad de valorar conjuntamente todos los factores que intervienen para la selección de la rueda adecuada, se recomienda realizar una prueba previa con las ruedas seleccionadas.

Ruedas

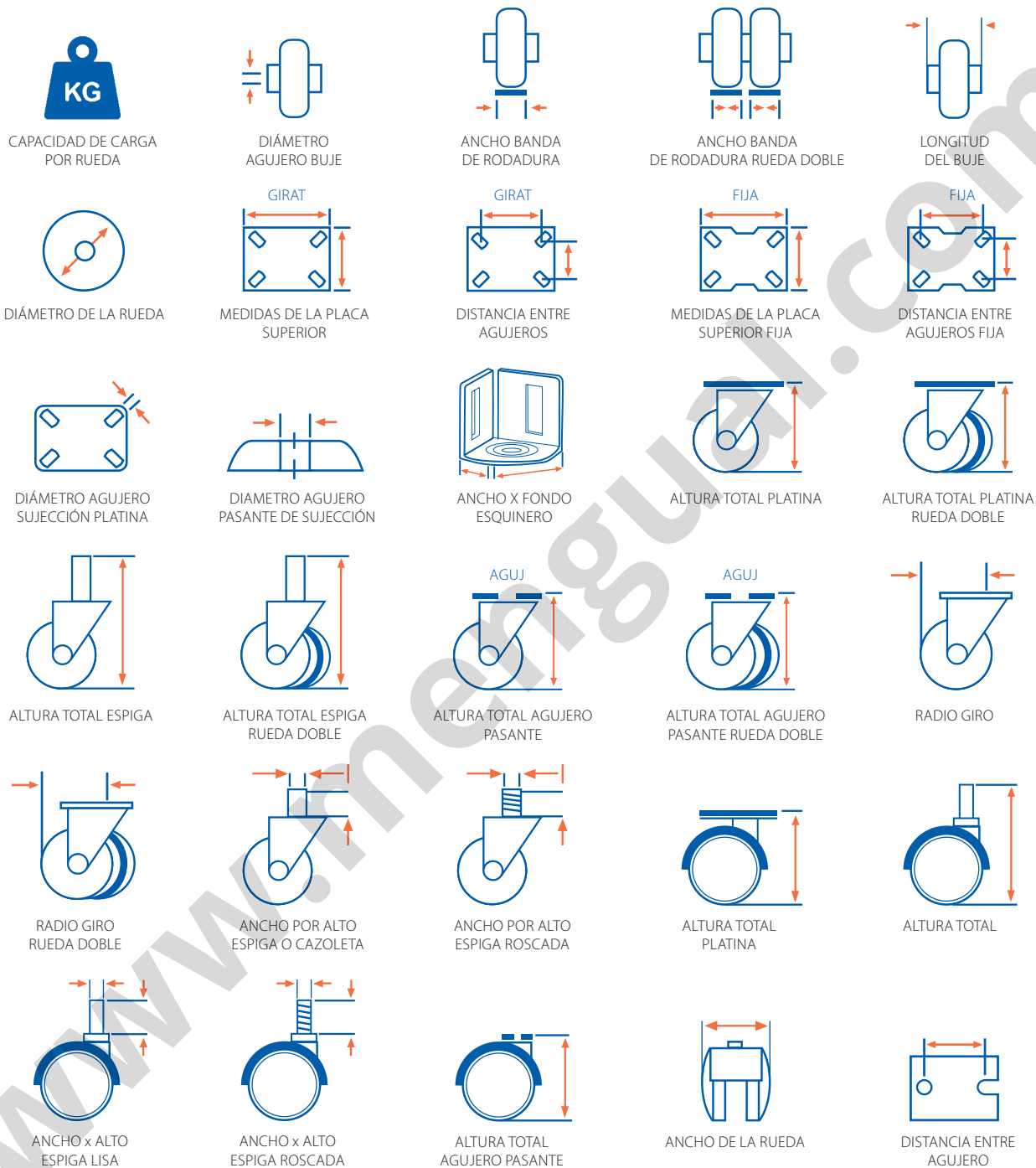

Cojinetes





Responsabilidad del fabricante en relación a sus productos

La responsabilidad del fabricante en relación a sus productos queda definida en **el libro III del Real Decreto Legislativo 1/2007 de 16 de Noviembre** referente a daños causados por productos (adaptación al derecho español de la directiva 85/374/CEE de 25 de julio de 1985).

Es preciso tener en cuenta la siguiente información respecto a las ruedas. Su inobservancia libera al fabricante de toda responsabilidad.

1. Información sobre el producto y su uso correcto.

Las ruedas son componentes sustituibles que se montan en aparatos para proporcionarles movilidad siempre de forma pasiva. Su uso correcto incluye el montaje de las ruedas en los aparatos como sigue:

- A) las ruedas deben estar firmemente unidas al aparato en todos los puntos previstos.
- B) El aparato debe tener la suficiente resistencia en estos puntos.
- C) El montaje al aparato no debe afectar ni modificar el funcionamiento de la rueda.
- D) Las ruedas giratorias deben ser montadas de tal forma que sus ejes giratorios estén en posición vertical.
- E) Las ruedas fijas deben montarse de tal modo que los ejes de las ruedas, una con la otra, estén exactamente alineados.
- F) Sólo se puede montar en un aparato ruedas giratorias del mismo tipo.

2. Uso inadecuado.

Se realiza un uso inadecuado de las ruedas en los siguientes casos:

- A) Si se aplican a las ruedas cargas superiores a la carga máxima indicada en el catálogo.

- B) Se aplican en suelos inapropiados e irregulares.
- C) Existen temperaturas ambiente muy elevadas o muy bajas.
- D) Se realiza un movimiento forzoso o violento de un aparato con las ruedas frenadas.
- E) Se someten a fuerzas excesivas debido a golpes y caídas.
- F) Cuando penetran cuerpos extraños en el bandaje de la rueda.
- G) Cuando se emplean las ruedas a velocidades excesivamente altas.
- H) Modificaciones o cambios realizados en las ruedas sin acuerdo previo y por escrito del fabricante.

3. Rendimiento del producto.

Las ruedas son diseñadas y fabricadas para tener un rendimiento óptimo según las normas europeas descritas en los capítulos EN 12526 a EN 12531 ambos inclusive, elaboradas por la **FEDERATION EUROPEENNE DE LA MANUTENTION**.

4. Mantenimiento del producto.

Las ruedas deben someterse regularmente a mantenimiento mediante las siguientes acciones:

- A) Engrase de los cojinetes
- B) Reajuste de uniones solubles

La limpieza de las ruedas se debe hacer siempre con productos no corrosivos.

Si una vez realizado el mantenimiento las ruedas, no tienen un rendimiento adecuado, éstas deben ser sustituidas.

5. Obligación de información y formación.

Para garantizar la adecuada funcionalidad de las ruedas, el comerciante debe observar ésta información sobre el producto y entregarla al usuario final.

6. Recomendaciones

A) Con motivo de la constante mejora y desarrollo de nuestros propios productos, Alex se reserva el derecho de efectuar cualquier cambio que crea oportuno en los artículos de este catálogo, sin previo aviso.

B) Todas las especificaciones y recomendaciones que se dan en este catálogo, son a título orientativo, siendo necesario en todos los casos proceder previamente a una prueba práctica de acuerdo con las condiciones de trabajo y los usos específicos de cada rueda.

C) Las capacidades de carga dadas en éste catálogo son recomendaciones generales. Pueden variar según el tipo y condiciones de trabajo. Las cargas están recomendadas para condiciones ideales de trabajo.

D) Si en éste catálogo no encuentra el modelo o la medida que usted precisa, consúltenos.

Somos fabricantes.



Guía de

fijaciones por platinas

ÍNDICE

- Alta **Capacidad de Carga** [pág. 22](#)
- Ruedas de **Transporte Industrial** [pág. 24](#)
- Ruedas **Inoxidables** [pág. 28](#)
- Ruedas para **Colectividades** [pág. 30](#)
- Ruedas para **Muebles Auxiliares** [pág. 32](#)
- Ruedas **Neumáticas** [pág. 35](#)
- Ruedas para **Decoración** [pág. 36](#)

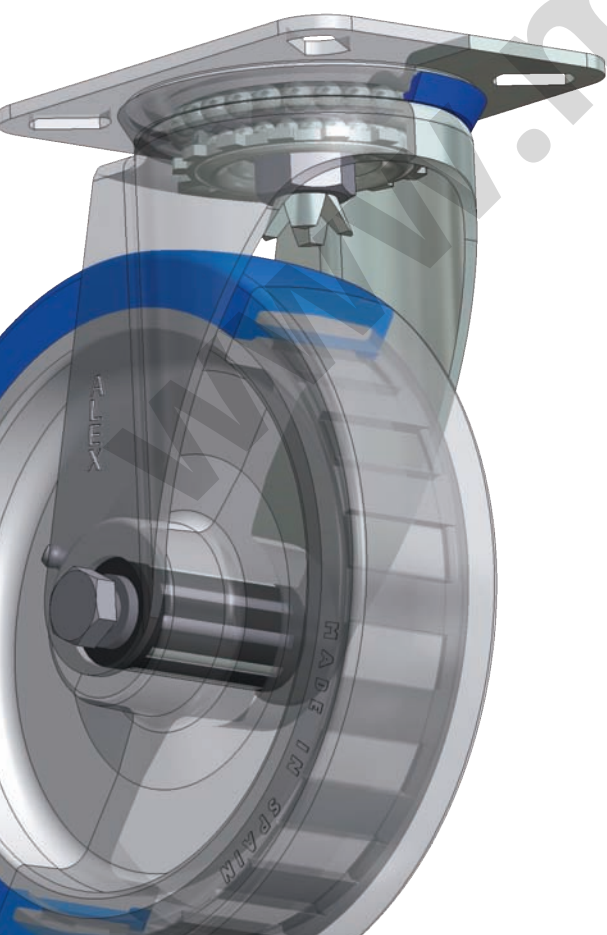

Fijaciones por platinas

Ruedas de alta capacidad de carga

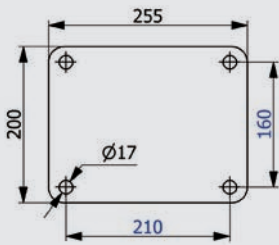

Serie HLR

SOPORTE GIRATORIO y FIJO
Ø200 / Ø250 / Ø300 mm

Fabricadas según normas europeas
EN 12532

Distancia entre agujeros de fijación
según norma ISO 22883:2004

*más información en página 40

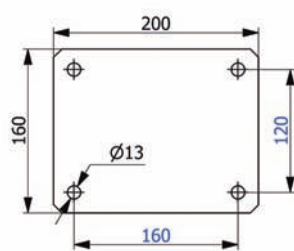

Serie HLG

SOPORTE GIRATORIO y FIJO
Ø150 / Ø200 / Ø250 mm

Fabricadas según normas europeas
EN 12532/12533

Distancia entre agujeros de fijación
según norma ISO 22883:2004

*más información en página 42

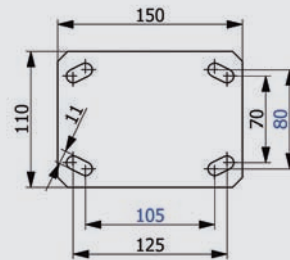

Serie HLB

SOPORTE GIRATORIO y FIJO
Ø100 / Ø125 / Ø150 / Ø160 /
Ø200 / Ø250E mm

Fabricadas según normas europeas
EN 12532/12533

Distancia entre agujeros de fijación
según norma ISO 22883:2004

*más información en página 46

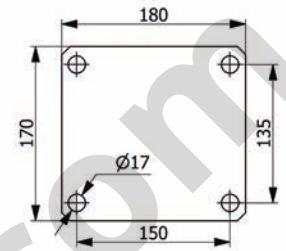

Serie HLB

SOPORTE GIRATORIO y FIJO
Ø250H / Ø250A / Ø300H
Ø300A mm

Fabricadas según normas europeas
EN 12532/12533

*más información en página 46

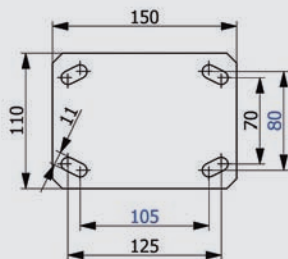

Serie HLS

SOPORTE GIRATORIO y FIJO
Ø150 / Ø160 / Ø200 / Ø250 mm

Fabricadas según normas europeas
EN 12532/12533

Distancia entre agujeros de fijación
según norma ISO 22883:2004

*más información en página 52

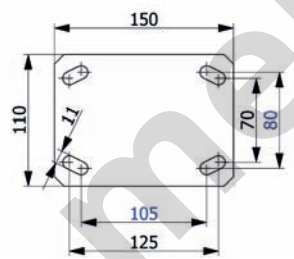

Serie HLSB

SOPORTE GIRATORIO y FIJO
Ø150 / Ø160 / Ø200 mm

Fabricadas según normas europeas
EN 12532/12533

Distancia entre agujeros de fijación
según norma ISO 22883:2004

*más información en página 56

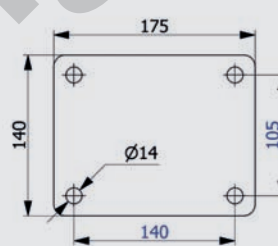

Serie HLSB

SOPORTE GIRATORIO y FIJO
Ø250 mm

Fabricadas según normas europeas
EN 12532/12533

Distancia entre agujeros de fijación
según norma ISO 22883:2004

*más información en página 66

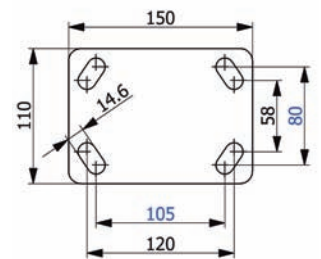

Serie GT

SOPORTE GIRATORIO y FIJO
Ø150 / Ø200 / Ø250 mm

Fabricadas según normas europeas
EN 12532/12533

Distancia entre agujeros de fijación
según norma ISO 22883:2004

*más información en página 62

Fijaciones por platinas

Ruedas de alta capacidad de carga

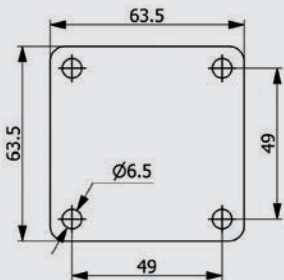

Serie FM

SOPORTE GIRATORIO
Ø40 mm

Fabricadas según normas europeas
EN 12530

*más información en página 66

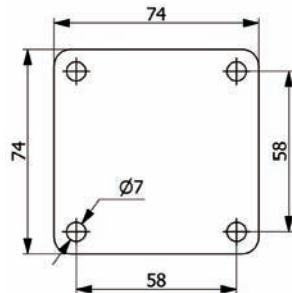

Serie FM

SOPORTE GIRATORIO
Ø60 mm

Fabricadas según normas europeas
EN 12530

*más información en página 66

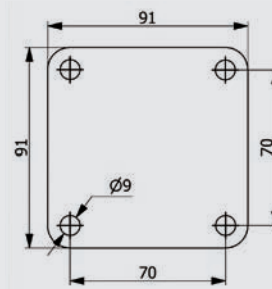

Serie FM

SOPORTE GIRATORIO
Ø80 mm

Fabricadas según normas europeas
EN 12530

*más información en página 66

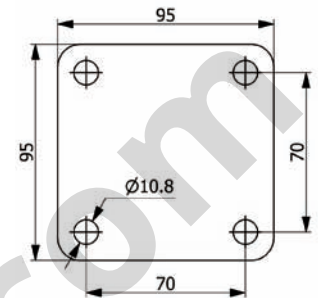

Serie FM

SOPORTE GIRATORIO
Ø100 mm

Fabricadas según normas europeas
EN 12530

*más información en página 66

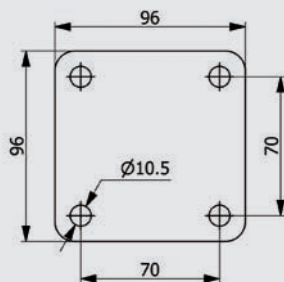

Serie FM

SOPORTE GIRATORIO
Ø120 mm

Fabricadas según normas europeas
EN 12530

*más información en página 66

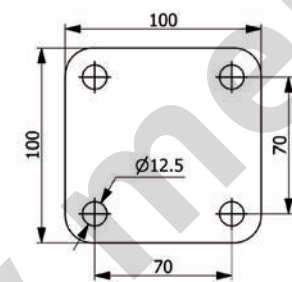

Serie FM

SOPORTE GIRATORIO
Ø150 mm

Fabricadas según normas europeas
EN 12530

*más información en página 66

Fijaciones por platinas

Ruedas de transporte industrial

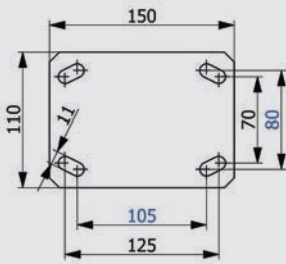

Serie SLR

SOPORTE **GIRATORIO** y **FIJO**
 $\varnothing 82 / \varnothing 85 / \varnothing 150 / \varnothing 200$ mm

Fabricadas según normas europeas
 EN 12532/12533
 Distancia entre agujeros de fijación
 según norma ISO 22883:2004

*más información en página 72

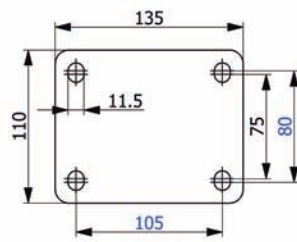

Serie SL

SOPORTE **GIRATORIO** y **FIJO**
 $\varnothing 100 / \varnothing 125 / \varnothing 150 / \varnothing 200$ mm

Fabricadas según normas europeas
 EN 12532
 Distancia entre agujeros de fijación
 según norma ISO 22883:2004

*más información en página 80

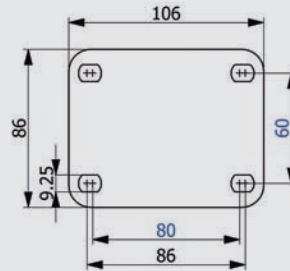

Serie TV

SOPORTE **GIRATORIO**
 $\varnothing 80 / \varnothing 100$ mm

Fabricadas según normas europeas
 EN 12532
 Distancia entre agujeros de fijación
 según norma ISO 22883:2004 y ISO
 22881:2004

*más información en página 84

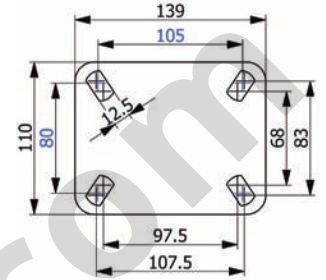

Serie TV

SOPORTE **GIRATORIO**
 $\varnothing 125 / \varnothing 150 / \varnothing 160 / \varnothing 200$ mm

Fabricadas según normas europeas
 EN 12532
 Distancia entre agujeros de fijación
 según norma ISO 22883:2004

*más información en página 84

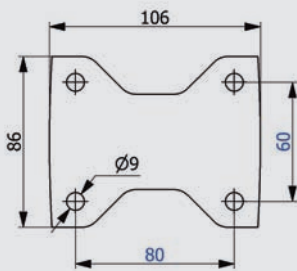

Serie TV

SOPORTE **FIJO**
 $\varnothing 80 / \varnothing 100$ mm

Fabricadas según normas europeas
 EN 12532
 Distancia entre agujeros de fijación
 según norma ISO 22883:2004 y ISO
 22881:2004

*más información en página 84

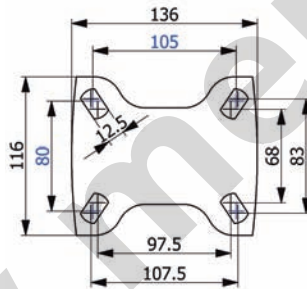

Serie TV

SOPORTE **FIJO**
 $\varnothing 125 / \varnothing 150 / \varnothing 160 / \varnothing 200$ mm

Fabricadas según normas europeas
 EN 12532
 Distancia entre agujeros de fijación
 según norma ISO 22883:2004

*más información en página 84

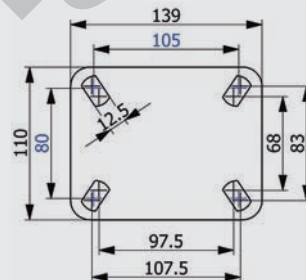

Serie TVC

SOPORTE **GIRATORIO**
 $\varnothing 125$ mm

Fabricadas según normas europeas
 EN 12532
 Distancia entre agujeros de fijación
 según norma ISO 22883:2004

*más información en página 94

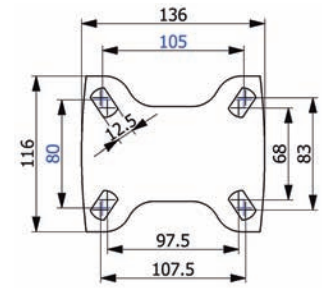

Serie TVC

SOPORTE **FIJO**
 $\varnothing 125$ mm

Fabricadas según normas europeas
 EN 12532
 Distancia entre agujeros de fijación
 según norma ISO 22883:2004

*más información en página 94

Fijaciones por platinas

Ruedas de transporte industrial

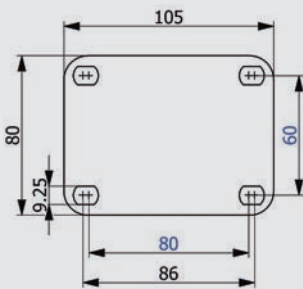

Serie ZV

SOPORTE GIRATORIO
Ø80 / Ø100L / Ø125L mm

Fabricadas según normas europeas
EN 12530/12532
Distancia entre agujeros de fijación
según norma ISO 22883:2004 y ISO
22881:2004

*más información en página 106

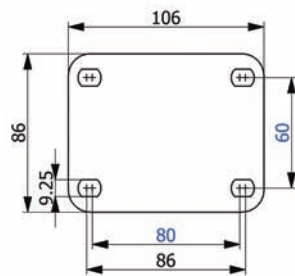

Serie ZV

SOPORTE GIRATORIO
Ø100 / Ø125 / 150L mm

Fabricadas según normas europeas
EN 12530/12532
Distancia entre agujeros de fijación
según norma ISO 22883:2004 y ISO
22881:2004

*más información en página 106

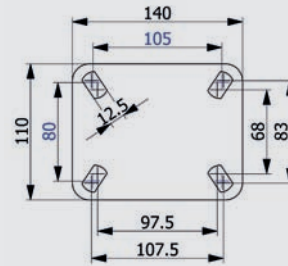

Serie ZVR-ZV

SOPORTE GIRATORIO
Ø150 / Ø160 / Ø200 / Ø250 mm

Fabricadas según normas europeas
EN 12532
Distancia entre agujeros de fijación
según norma ISO 22883:2004

*más información en página 98-106

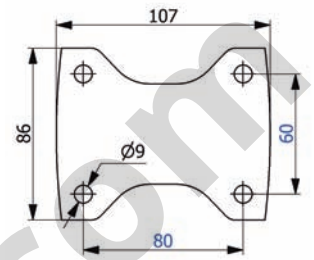

Serie ZV

SOPORTE FIJO
Ø80 / Ø100L / Ø100 / Ø125L /
Ø125 / Ø150L mm

Fabricadas según normas europeas
EN 12530/12532
Distancia entre agujeros de fijación
según norma ISO 22883:2004 y ISO
22881:2004

*más información en página 106

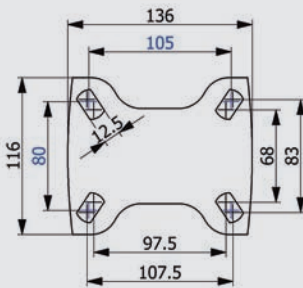

Serie ZVR-ZV

SOPORTE FIJO
Ø150 / Ø160 / Ø200 mm

Fabricadas según normas europeas
EN 12532
Distancia entre agujeros de fijación
según norma ISO 22883:2004

*más información en página 98-106

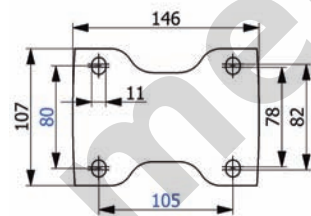

Serie ZV

SOPORTE FIJO
Ø250 mm

Fabricadas según normas europeas
EN 12530
Distancia entre agujeros de fijación
según norma ISO 22883:2004

*más información en página 106

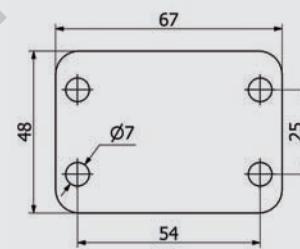

Serie 61

SOPORTE GIRATORIO
Ø50 mm

Fabricadas según normas europeas
EN 12532

*más información en página 138

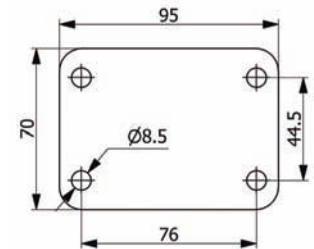

Serie 61

SOPORTE GIRATORIO
Ø60 mm

Fabricadas según normas europeas
EN 12532

*más información en página 138

Fijaciones por platinas

Ruedas de transporte industrial

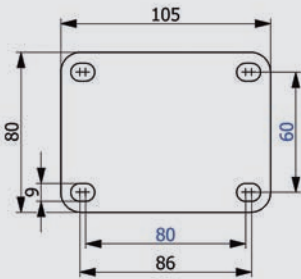

Serie 61

SOPORTE GIRATORIO
Ø80 mm

Fabricadas según normas europeas
EN 12532

Distancia entre agujeros de fijación
según norma ISO 22883:2004 y ISO
22881:2004

*más información en página 138

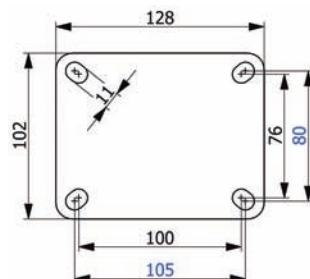

Serie 61

SOPORTE GIRATORIO
Ø100 mm

Fabricadas según normas europeas
EN 12532

Distancia entre agujeros de fijación
según norma ISO 22883:2004

*más información en página 138

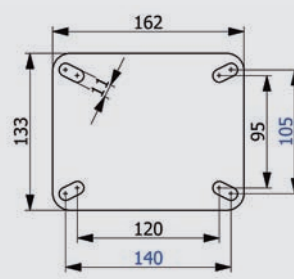

Serie 61

SOPORTE GIRATORIO
Ø125 mm

Fabricadas según normas europeas
EN 12532

Distancia entre agujeros de fijación
según norma ISO 22883:2004

*más información en página 138

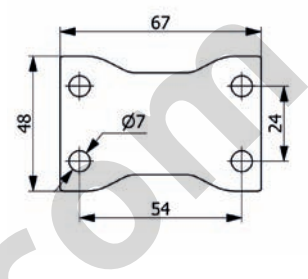

Serie 61

SOPORTE FIJO
Ø50 mm

Fabricadas según normas europeas
EN 12532

*más información en página 138

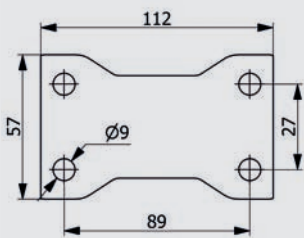

Serie 61

SOPORTE FIJO
Ø60 mm

Fabricadas según normas europeas
EN 12532

*más información en página 138

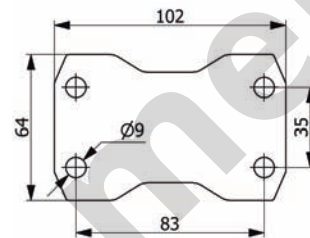

Serie 61

SOPORTE FIJO
Ø80 mm

Fabricadas según normas europeas
EN 12532

*más información en página 138

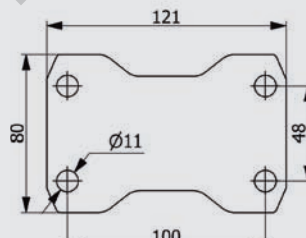

Serie 61

SOPORTE FIJO
Ø100 / Ø125 mm

Fabricadas según normas europeas
EN 12532

*más información en página 138

Fijaciones por platinas

Ruedas de transporte industrial

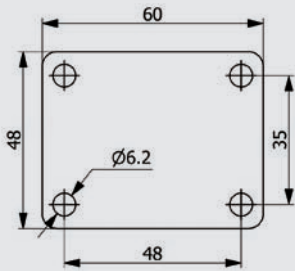

Serie LP

SOPORTE GIRATORIO
Ø35 mm

Fabricadas según normas europeas
EN 12532

*más información en página 142

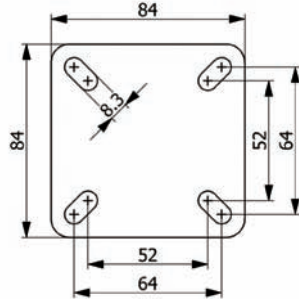

Serie LP

SOPORTE GIRATORIO y FIJO
Ø50 mm

Fabricadas según normas europeas
EN 12532

*más información en página 142

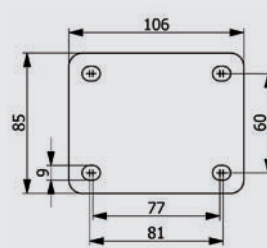

Serie LP

SOPORTE GIRATORIO y FIJO
Ø75 mm

Fabricadas según normas europeas
EN 12532

*más información en página 142

Fijaciones por platinas

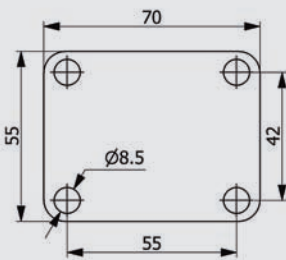

Serie ZVI

SOPORTE GIRATORIO
Ø60 mm

Fabricadas según normas europeas
EN 12530/12532

*más información en página 154

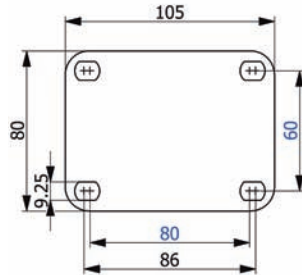

Serie ZVI

SOPORTE GIRATORIO
Ø80 / Ø100L / Ø125L mm

Fabricadas según normas europeas
EN 12530/12532

Distancia entre agujeros de fijación
según norma ISO 22883:2004 y ISO
22881:2004

*más información en página 154

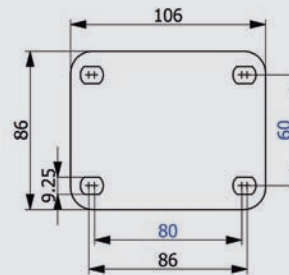

Serie ZVI

SOPORTE GIRATORIO
Ø100 / Ø125 mm

Fabricadas según normas europeas
EN 12530/12532

Distancia entre agujeros de fijación
según norma ISO 22883:2004 y ISO
22881:2004

*más información en página 154

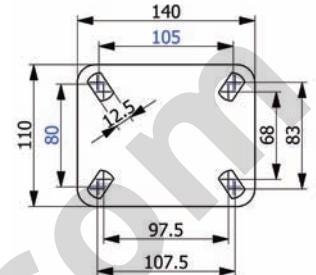

Serie ZVI

SOPORTE GIRATORIO
Ø150 / Ø160 / Ø200 mm

Fabricadas según normas europeas
EN 12532

Distancia entre agujeros de fijación
según norma ISO 22883:2004

*más información en página 154

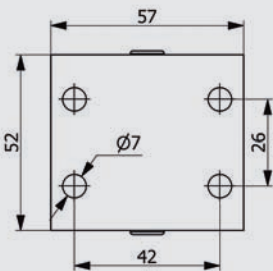

Serie ZVI

SOPORTE FIJO
Ø60 mm

Fabricadas según normas europeas
EN 12530/12532

*más información en página 154

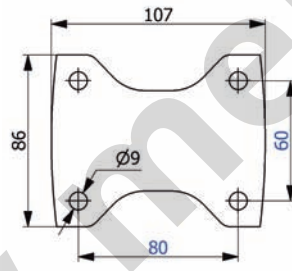

Serie ZVI

SOPORTE FIJO
Ø80 / Ø100L / Ø100 / Ø125L /
Ø125 mm

Fabricadas según normas europeas
EN 12530/12532

Distancia entre agujeros de fijación
según norma ISO 22883:2004 y ISO
22881:2004

*más información en página 154

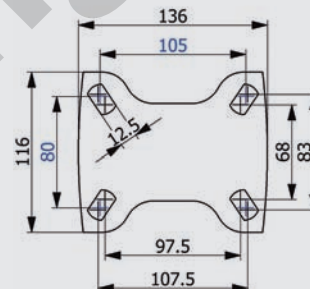

Serie ZVI

SOPORTE FIJO
Ø150 / Ø160 / Ø200 mm

Fabricadas según normas europeas
EN 12532

Distancia entre agujeros de fijación
según norma ISO 22883:2004

*más información en página 154

Fijaciones por platinas



Ruedas inoxidable

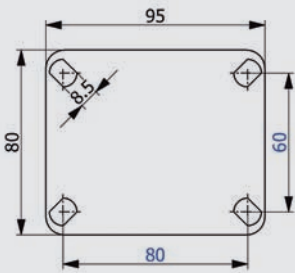

Serie ZLI

SOPORTE GIRATORIO
Ø80 / Ø100 / Ø125 mm

Fabricadas según normas europeas
EN 12530/12532

Distancia entre agujeros de fijación
según norma ISO 22883:2004 y ISO
22881:2004

*más información en página 172

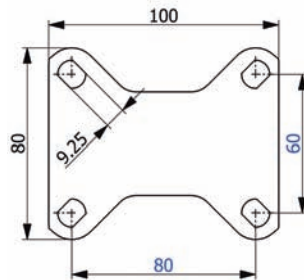

Serie ZLI

SOPORTE FIJO
Ø80 / Ø100 / Ø125 mm

Fabricadas según normas europeas
EN 12530/12532

Distancia entre agujeros de fijación
según norma ISO 22883:2004 y ISO
22881:2004

*más información en página 172

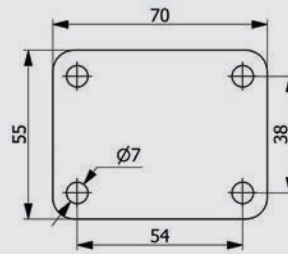

Serie BHI

SOPORTE GIRATORIO
Ø60 mm / Ø80 mm / Ø100 mm

Fabricadas según normas europeas
EN 12530

*más información en página 176

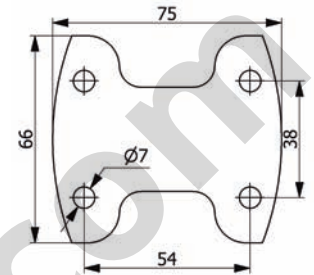

Serie BHI

SOPORTE FIJO
Ø60 mm / Ø80 / Ø100 mm

Fabricadas según normas europeas
EN 12530

*más información en página 176

Fijaciones por platinas

Ruedas para colectividades

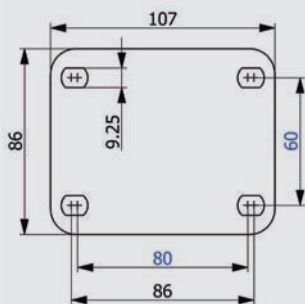

Serie A

SOPORTE **GIRATORIO**
Ø80 / Ø100 / Ø125 / Ø200 mm

Fabricadas según normas europeas
EN 12530/12532

Distancia entre agujeros de fijación
según norma ISO 22883:2004 y ISO
22881:2004

*más información en página 182

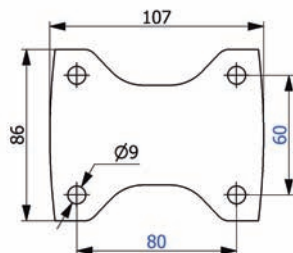

Serie A

SOPORTE **FIJO**
Ø80 / Ø100 / Ø125 / Ø150 mm

Fabricadas según normas europeas
EN 12530/12532

Distancia entre agujeros de fijación
según norma ISO 22883:2004 y ISO
22881:2004

*más información en página 182

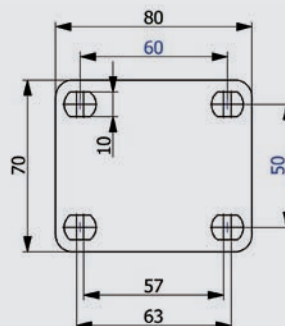

Serie BHA

SOPORTE **GIRATORIO**
Ø100 / Ø125 mm

Fabricadas según normas europeas
EN 12530

Distancia entre agujeros de fijación
según norma ISO 22881:2004

*más información en página 188

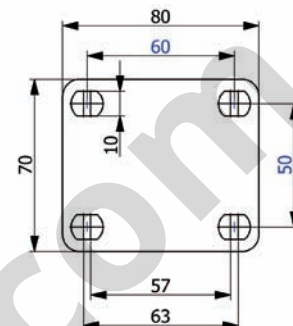

Serie HC

SOPORTE **GIRATORIO**
Ø125 mm

Fabricadas según normas europeas
EN 12530

Distancia entre agujeros de fijación
según norma ISO 22881:2004

*más información en página 192

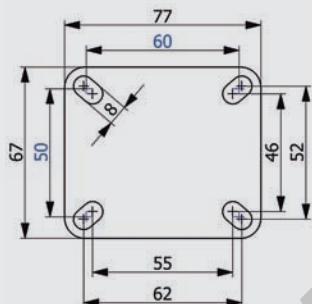

Serie AN

SOPORTE **GIRATORIO**
Ø100 / Ø125 mm

Fabricadas según normas europeas
EN 12530

Distancia entre agujeros de fijación
según norma ISO 22881:2004

*más información en página 196

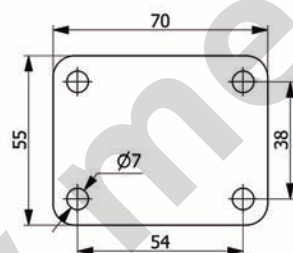

Serie BH

SOPORTE **GIRATORIO**
Ø60 / Ø80 / Ø100 mm

Fabricadas según normas europeas
EN 12530

*más información en página 204

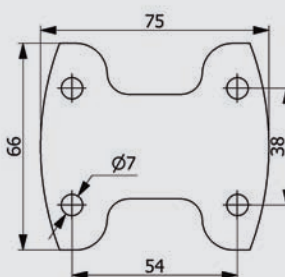

Serie BH

SOPORTE **FIJO**
Ø60 / Ø80 / Ø100 mm

Fabricadas según normas europeas
EN 12530

*más información en página 204

Fijaciones por platinas

Ruedas para colectividades

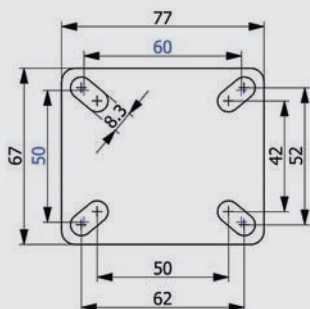

Serie IG

SOPORTE GIRATORIO
Ø75 mm

Fabricadas según normas europeas
EN 12530

Distancia entre agujeros de fijación
según norma ISO 22881:2004

*más información en página 210

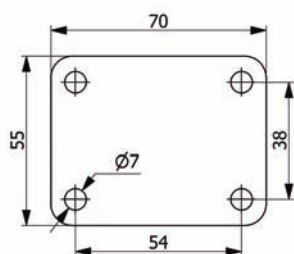

Serie I

SOPORTE GIRATORIO
Ø50 mm

Fabricadas según normas europeas
EN 12530

*más información en página 212

Fijaciones por platinas

Ruedas para muebles auxiliares

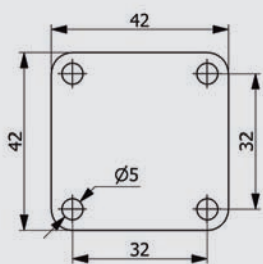

Serie HP

SOPORTE GIRATORIO
Ø50 mm

Fabricadas según normas europeas
EN 12528

*más información en página 218

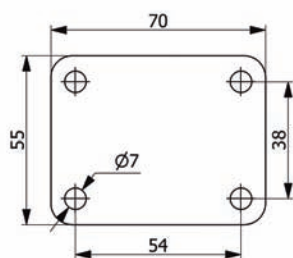

Serie IB

SOPORTE GIRATORIO
Ø40 / Ø50 mm

Fabricadas según normas europeas
EN 12528

*más información en página 222

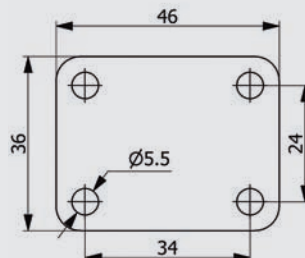

Serie BD

SOPORTE GIRATORIO
Ø30 / Ø40 mm

Fabricadas según normas europeas
EN 12528

*más información en página 224

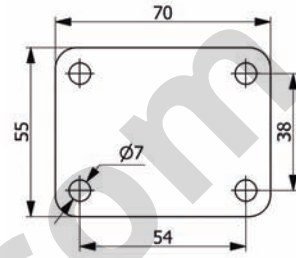

Serie BD

SOPORTE GIRATORIO
Ø50 / Ø60 mm

Fabricadas según normas europeas
EN 12528

*más información en página 224

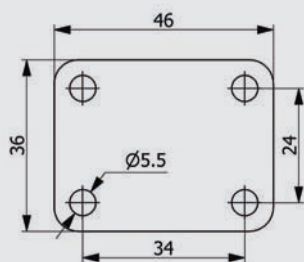

Serie B

SOPORTE GIRATORIO
Ø30 / Ø40 mm

Fabricadas según normas europeas
EN 12528

*más información en página 230

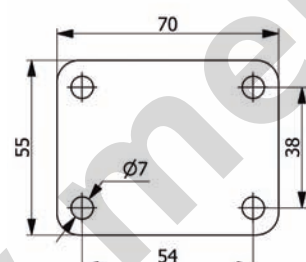

Serie B

SOPORTE GIRATORIO
Ø50 / Ø60 mm

Fabricadas según normas europeas
EN 12528

*más información en página 230

Fijaciones por platinas

Ruedas para muebles auxiliares

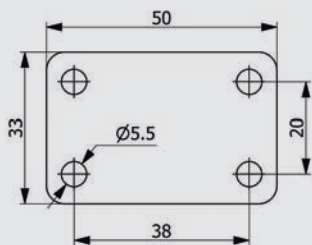

Serie H

SOPORTE GIRATORIO
Ø25 mm

Fabricadas según normas europeas
EN 12528

*más información en página 234

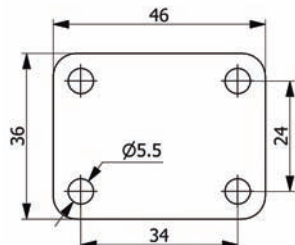

Serie H

SOPORTE GIRATORIO
Ø30 / Ø40 mm

Fabricadas según normas europeas
EN 12528

*más información en página 234

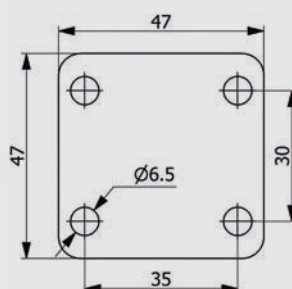

Serie Z

SOPORTE GIRATORIO
Ø35 mm

Fabricadas según normas europeas
EN 12528

*más información en página 236

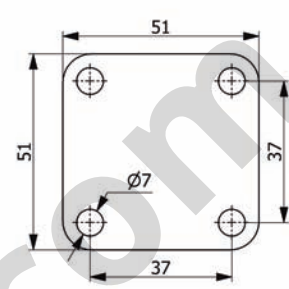

Serie Z

SOPORTE GIRATORIO
Ø40 mm

Fabricadas según normas europeas
EN 12528

*más información en página 236

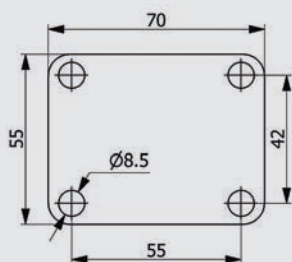

Serie Z

SOPORTE GIRATORIO
Ø60 mm

Fabricadas según normas europeas
EN 12528

*más información en página 236

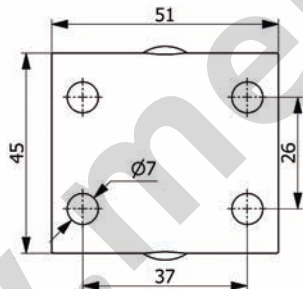

Serie Z

SOPORTE FIJO
Ø40 mm

Fabricadas según normas europeas
EN 12528

*más información en página 236

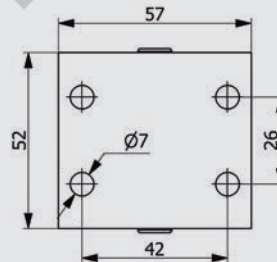

Serie Z

SOPORTE FIJO
Ø60 mm

Fabricadas según normas europeas
EN 12528

*más información en página 236

Fijaciones por platinas

Ruedas para muebles auxiliares

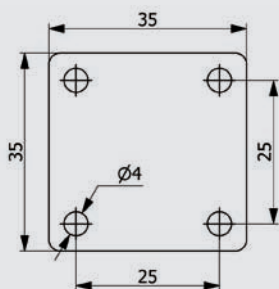

Serie DK negro

SOPORTE GIRATORIO
Ø30 mm

Fabricadas según normas europeas
EN 12528

*más información en página 242

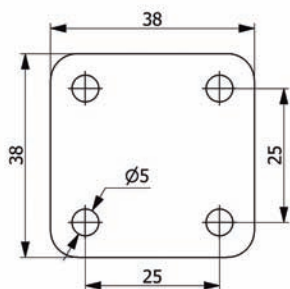

Serie DK negro

SOPORTE GIRATORIO
Ø40 / Ø45 mm

Fabricadas según normas europeas
EN 12528

*más información en página 242

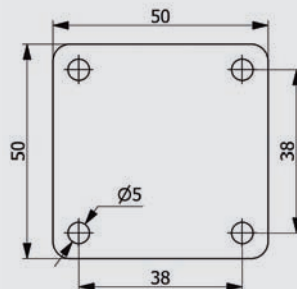

Serie DK negro

SOPORTE GIRATORIO
Ø50 / Ø60 mm

Fabricadas según normas europeas
EN 12528

*más información en página 242

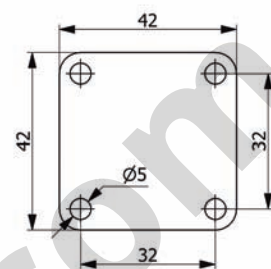

Serie DK poliuretano

SOPORTE GIRATORIO
Ø50 mm

Fabricadas según normas europeas
EN 12528

*más información en página 246

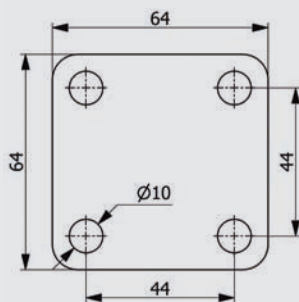

Serie DKG

SOPORTE GIRATORIO
Ø80 / Ø100 / Ø120 mm

Fabricadas según normas europeas
EN 12528

*más información en página 245

Fijaciones por platinas

Ruedas neumáticas

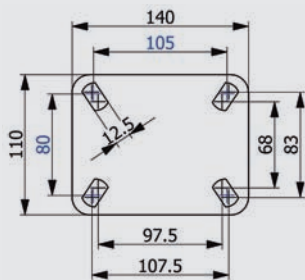

Serie ZV

SOPORTE GIRATORIO
Ø200 mm

Fabricadas según normas europeas
EN 12532

Distancia entre agujeros de fijación
según norma ISO 22883:2004

*más información en página 248

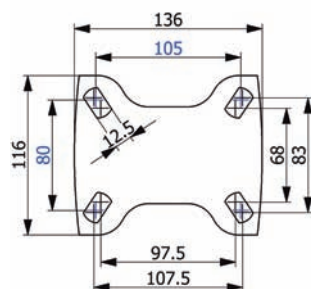

Serie ZV

SOPORTE FIJO
Ø200 mm

Fabricadas según normas europeas
EN 12532

Distancia entre agujeros de fijación
según norma ISO 22883:2004

*más información en página 248

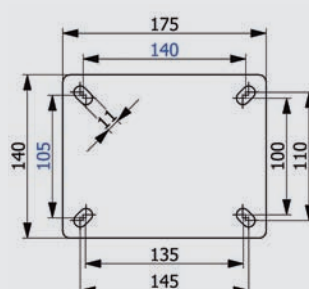

Serie WL

SOPORTE GIRATORIO
Ø260 mm

Fabricadas según normas europeas
EN 12532

Distancia entre agujeros de fijación
según norma ISO 22883:2004

*más información en página 252

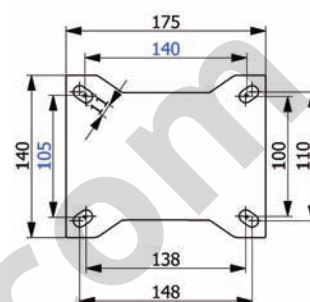

Serie WL

SOPORTE FIJO
Ø260 mm

Fabricadas según normas europeas
EN 12532

Distancia entre agujeros de fijación
según norma ISO 22883:2004

*más información en página 252

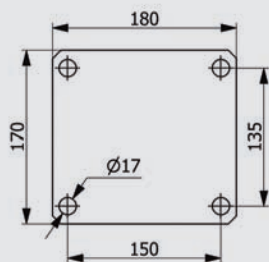

Serie HLBI

SOPORTE GIRATORIO y FIJO
Ø320 / Ø400 mm

Fabricadas según normas europeas
EN 12532 / EN 12533

*más información en página 256

Fijaciones por platinas

Ruedas para decoración

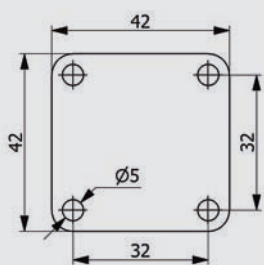

Serie ALU - BDM

SOPORTE GIRATORIO

Ø50 mm

*más información en página 260

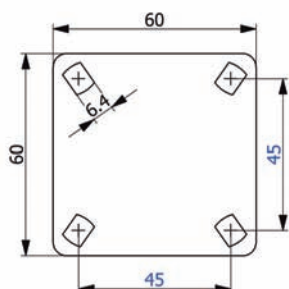

Serie ALU - BDM

SOPORTE GIRATORIO

Ø75 / Ø100 mm

Distancia entre agujeros de fijación según norma ISO 22881:2004

*más información en página 260

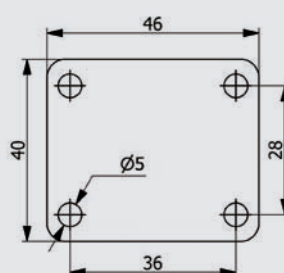

Serie CLR

SOPORTE GIRATORIO

Ø40 mm

*más información en página 261

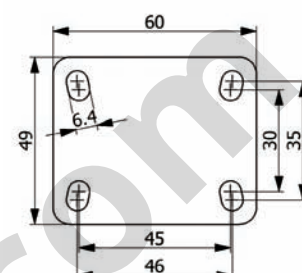

Serie CLR

SOPORTE GIRATORIO

Ø50 mm

*más información en página 261

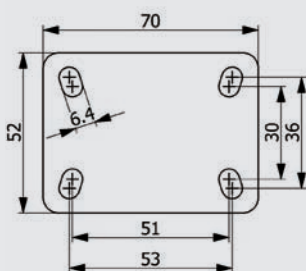

Serie CLR

SOPORTE GIRATORIO

Ø60 mm

*más información en página 261

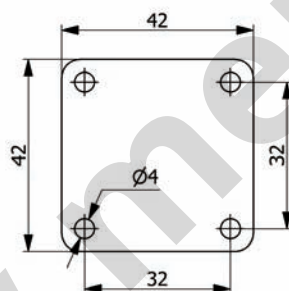

Serie BDT

SOPORTE GIRATORIO

Ø50 mm

*más información en página 261

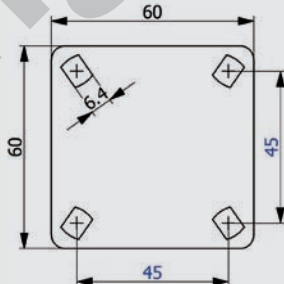

Serie BDT

SOPORTE GIRATORIO

Ø75 mm

Distancia entre agujeros de fijación según norma ISO 22881:2004

*más información en página 261

Fijaciones por platinas

Ruedas para decoración

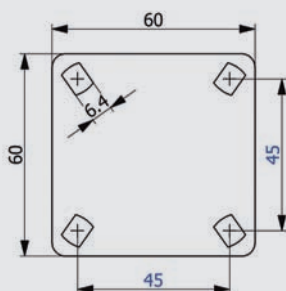

Serie RD

SOPORTE **GIRATORIO**
Ø75 mm

Distancia entre agujeros de fijación según norma ISO 22881:2004

*más información en página 262

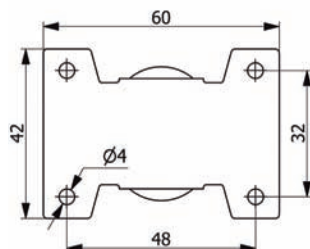

Serie MDC

SOPORTE **FIJO**
Ø50 mm

*más información en página 263

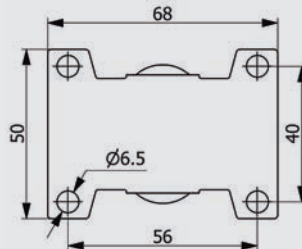

Serie MDC

SOPORTE **FIJO**
Ø75 mm

*más información en página 263

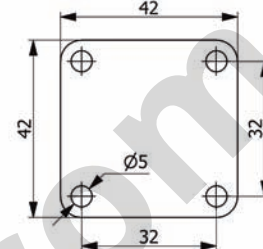

Serie MDC

SOPORTE **GIRATORIO**
Ø50 mm

*más información en página 263

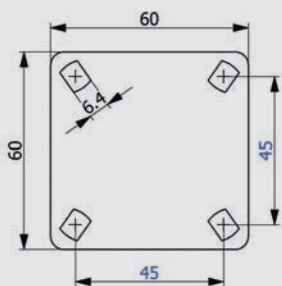

Serie MDC

SOPORTE **GIRATORIO**
Ø75 mm

Distancia entre agujeros de fijación según norma ISO 22881:2004

*más información en página 263

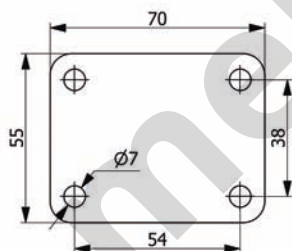

Serie BH

SOPORTE **GIRATORIO**
Ø60 / Ø 80 / Ø100 mm

Fabricadas según normas europeas EN 12530

*más información en página 264

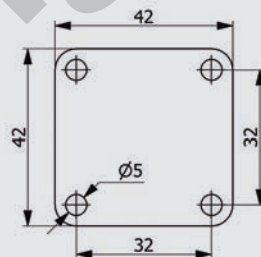

Serie BLS - BLC

SOPORTE **GIRATORIO**
Ø50 mm

*más información en página 265

Fijaciones por platinas

Ruedas para decoración

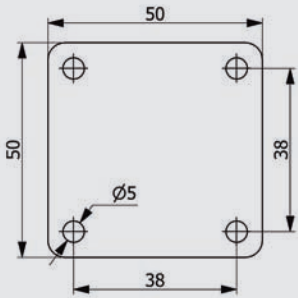

Serie DKP - DKM

SOPORTE GIRATORIO
Ø 60 / Ø75 mm

*más información en página 266-267

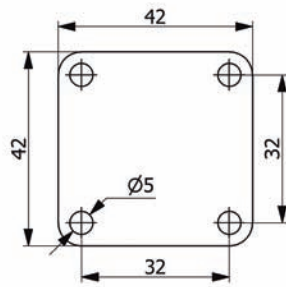

Serie DKP - DKM

SOPORTE GIRATORIO
Ø50 mm

*más información en página 266-267



Ruedas de

alta capacidad de carga

Hasta 6.000 kg por rueda

ÍNDICE

- Serie **HLR** pág. 40
- Serie **HLG** pág. 42
- Serie **HLB** pág. 46
- Serie **HLS** pág. 52
- Serie **HLSB** pág. 56
- Serie **GT** pág. 62
- Serie **FM** pág. 66
- Usos Especiales
- Serie **JA** pág. 68
- Accesorios **Frenos** pág. 69

* AMPLIAMOS
GAMA

NOVEDAD

NOVEDAD



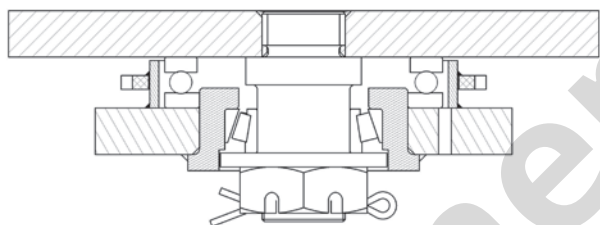

DETALLES DEL PRODUCTO

- ✓ Fabricada con acero forjado desde 8 m/m hasta 20 m/m de espesor.
- ✓ Cojinete superior reforzado construido mediante mecanización de precisión. Aloja un cojinete de bolas axial para esfuerzos verticales y un cojinete de rodillos cónicos para esfuerzos laterales.
- ✓ Cabezal giratorio protegido, con engrasador y atornillado mediante vástago central macizo soldado.
- ✓ Especialmente diseñada para el sector eólico, naval y ferroviario.



3.200 - 6.000 kg



200 a 300 mm

- » Acabado pintado negro
- » Fabricadas según normas europeas EN 12532

Disponible con bloqueo direccional. Convierte una rueda giratoria en fija.

Medidas Generales

	GIRAT *	FIJA *	GIRAT *	FIJA *	*		AGUJ	
200	255x200	255x200	210x160	210x160	16	-	290	160
250	255x200	255x200	210x160	210x160	16	-	330	205
300	255x200	255x200	210x160	210x160	16	-	390	230

* Detalle de planos de platina, ver página 22

Rueda NF

Nylon fundido extrafuerte

4.500 - 6.000 kg



VENTAJAS DEL ARO

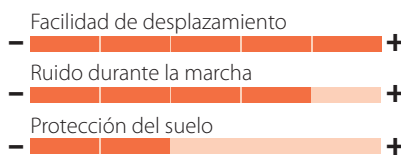

-30° a +80°

Más información en página 284

BLOQUEO DIRECCIONAL



Cojinete
Eje

200	80	
250	80	
300	80	

Código	KG
2-3595	4.500
2-3596	6.000
2-3597	6.000

Código	KG
2-3598	4.500
2-3599	6.000
2-3600	6.000

Código	KG
2-4254	4.500
2-4255	6.000
2-4256	6.000

Código	KG
2-4249	4.500
2-4250	6.000
2-4251	6.000

Rueda HU

Poliuretano fundido

3.200 - 4.000 kg



VENTAJAS DEL ARO

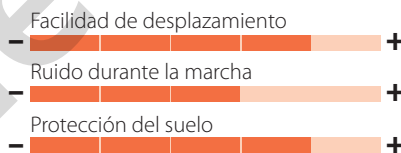

-20° a +50°

Más información en página 278

BLOQUEO DIRECCIONAL



Cojinete
Eje

250	75x2	
300	75x2	

Código	KG
2-3590	3.200
2-3591	4.000

Código	KG
2-3593	3.200
2-3594	4.000

Código	KG
2-4257	3.200
2-4258	4.000

Código	KG
2-4252	3.200
2-4253	4.000

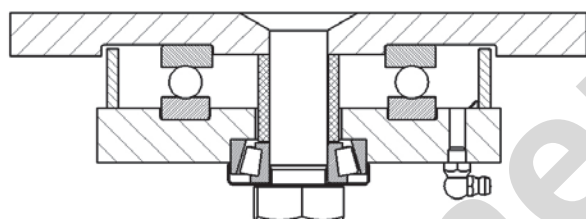

DETALLES DEL PRODUCTO

- ✓ Fabricada con acero soldado desde 8 m/m hasta 19 m/m de espesor.
- ✓ Cojinete superior construido mediante mecanización de precisión. Aloja un cojinete de bolas axial para esfuerzos verticales y un cojinete de rodillos cónicos para esfuerzos laterales.
- ✓ Modelo diseñado especialmente para: Puentes grúa, aviación, ejercito, puertos, etc.

800 - 2.600 kg **150 a 250 mm**

- » Acabado pintado negro
- » Fabricadas según normas europeas EN 12532/12533

Disponible con bloqueo direccional. Convierte una rueda giratoria en fija.

Medidas Generales

150	200x160	200x160	160x120	12	-	225	-	121
200	200x160	200x160	160x120	12	-	270	-	156
250	200x160	200x160	160x120	12	-	325	-	193

* Detalle de planos de platina, ver página 22

Rueda HG

Goma negra natural

800 - 1.400 kg



VENTAJAS DEL ARO

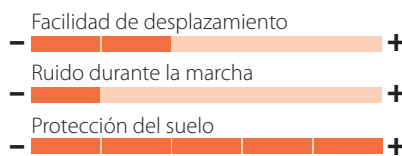

-20° a +60°

Más información en página 270



Cojinete Eje

150	50x2	
200	50x2	
250	50x2	

Código	KG
2-1853	800
2-1854	1.200
2-1855	1.400

Código	KG
2-1856	800
2-1857	1.200
2-1858	1.400

Código	KG
2-3807	800
2-3808	1.200
2-3809	1.400

Código	KG
2-3825	800
2-3826	1.200
2-3827	1.400

Rueda HU

Poliuretano fundido

1.600 - 2.500 kg



VENTAJAS DEL ARO

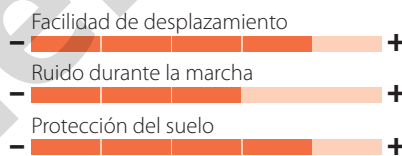

-20° a +60°

Más información en página 278



Cojinete Eje

150	50x2	
200	50x2	
250	50x2	

Código	KG
2-1865	1.600
2-1866	2.200
2-1867	2.500

Código	KG
2-1868	1.600
2-1869	2.200
2-1870	2.500

Código	KG
2-3810	1.600
2-3811	2.200
2-3812	2.500

Código	KG
2-3828	1.600
2-3829	2.200
2-3830	2.500

Rueda FT

Nylon extrafuerte

1.800 - 2.400 kg



VENTAJAS DEL ARO

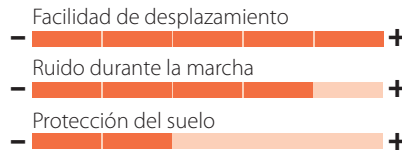

-30° a +80°

Más información en página 284

BLOQUEO DIRECCIONAL

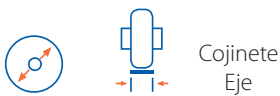

Cojinete
Eje

150	45x2	—
150	45x2	●●
200	50x2	—
200	50x2	●●
250	57x2	—
250	57x2	●●

Código	KG
2-1871	1.800
2-1872	1.800
2-1873	2.000
2-1874	2.000
2-1875	2.400
2-1876	2.400

Código	KG
2-1877	1.800
2-1878	1.800
2-1879	2.000
2-1880	2.000
2-1881	2.400
2-1882	2.400

Código	KG
2-3813	1.800
2-3816	1.800
2-3814	2.000
2-3817	2.000
2-3815	2.400
2-3818	2.400

Código	KG
2-3831	1.800
2-3834	1.800
2-3832	2.000
2-3835	2.000
2-3833	2.400
2-3836	2.400

Rueda TA

Rueda de acero

2.000 - 2.600 kg



VENTAJAS DEL ARO

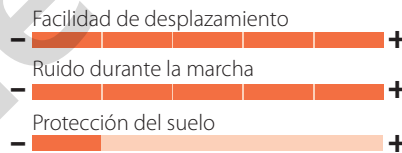

-90° a +600°

Más información en página 288

BLOQUEO DIRECCIONAL

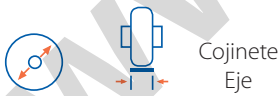

Cojinete
Eje

150	45x2	—
150	45x2	●●
200	45x2 <th>—</th>	—
200	45x2	●●
250	50x2	—
250	50x2	●●

Código	KG
2-1883	2.000
2-1884	2.000
2-1885	2.000
2-1886	2.000
2-1887	2.600

Código	KG
2-1888	2.000
2-1889	2.000
2-1890	2.000
2-1891	2.000
2-1892	2.600

Código	KG
2-3819	2.000
2-3822	2.000
2-3820	2.000
2-3823	2.000
2-3824	2.600

Código	KG
2-3837	2.000
2-3840	2.000
2-3838	2.000
2-3841	2.000
2-3842	2.600

Las versiones con cojinetes de bolas, deben trabajar en un rango de temperatura: -40° a +150°

Para temperaturas superiores a 200° reducir carga (kg) un 40%

Accesorio protección pie rígido



Código

150	2-3911
200	2-3912
250	2-3913



Para solicitar la protección pie, añadir a la rueda solicitada el código correspondiente.

**PROTECCIÓN
PIE**



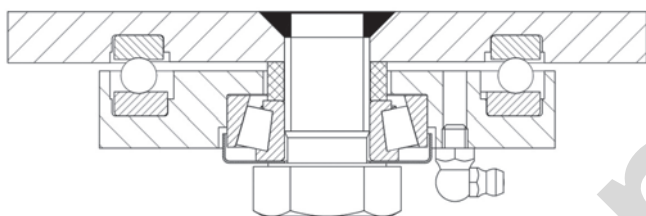

KG 200 - 2.750 kg 100 a 300 mm

- » Acabado pintado negro
- » Fabricadas según normas europeas EN 12532/12533

DETALLES DEL PRODUCTO

- ✓ Fabricada con acero soldado desde 8 m/m hasta 18 m/m de espesor.
- ✓ Doble cabezal giratorio, el superior de bolas grandes de acero y el inferior de precisión que facilita los esfuerzos de giro, radiales y axiales.
- ✓ Modelo construido especialmente para: carretillas grandes con empuje mecánico, mantenimiento de factorías, industrias metalúrgicas, químicas, servicios públicos.

Disponible con bloqueo direccional. Convierte una rueda giratoria en fija.

Medidas Generales

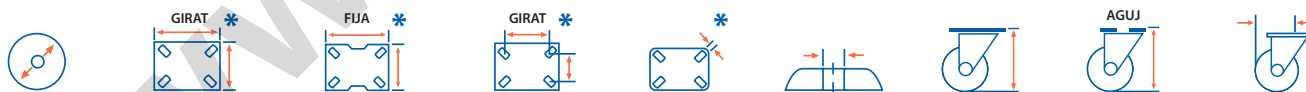

	GIRAT *	FIJA *	GIRAT *				AGUJ	
100	150x110	150x110	105x80	10	-	160	-	90
125	150x110	150x110	105x80	10	-	183	-	106
150	150x110	150x110	105x80	10	-	200	-	121
150A	180x170	180x170	150x135	16	-	200	-	121
160	150x110	150x110	105x80	10	-	205	-	126
200	150x110	150x110	105x80	10	-	249	-	155
250E	150x110	150x110	105x80	10	-	315	-	197
250H	180x170	180x170	150x135	16	-	315	-	197
250A	180x170	180x170	150x135	16	-	315	-	197
300H	180x170	180x170	150x135	16	-	360	-	230
300A	180x170	180x170	150x135	16	-	360	-	230

* Detalle de planos de platina, ver página 22

Rueda DE

Goma elástica

250 - 500 kg



VENTAJAS DEL ARO

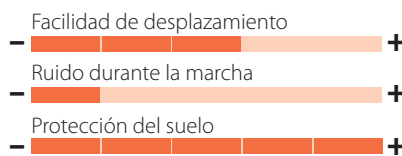

-20° a +70°

Más información en página 274

BLOQUEO DIRECCIONAL

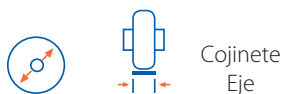

125	40	
160	50	
200	50	
250E	50	
250H	50	

Código	KG
2-1453	250
2-0449	350
2-0450	450
2-2285	500
4-1049	500

Código	KG
2-1442	250
2-0451	350
2-0452	450
2-2286	500
4-1058	500

Código	KG
-	-
-	-
2-1525	450
2-2287	500
2-1526	500

Código	KG
2-3349	250
2-3350	350
2-3351	450
2-3352	500
2-3353	500

Rueda HG

Goma negra natural

200 - 850 kg



VENTAJAS DEL ARO

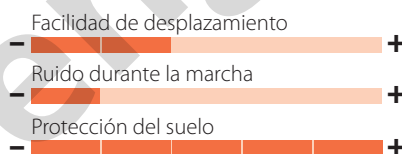

-20° a +60°

Más información en página 270

BLOQUEO DIRECCIONAL

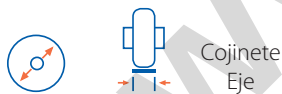

100	38	
125	38	
150	50	
200	50	
250E	50	
250H	50	
250A	75	
300H	50	
300A	75	

Código	KG
2-0453	200
2-0454	250
2-1951	400
2-1952	600
2-2289	700
2-1953	700
2-3563	750
2-0983	750
2-3564	850

Código	KG
2-0458	200
2-0459	250
2-1956	400
2-1957	600
2-2291	700
2-1958	700
2-3565	750
2-0984	750
2-3566	850

Código	KG
-	-
-	-
2-1959	400
2-1960	600
2-2293	700
2-1961	700
2-3567	750
2-1518	750
2-3568	850

Código	KG
2-3354	200
2-3355	250
2-3356	400
2-3357	600
2-3358	700
2-3359	700
2-3744	750
2-3360	750
2-3745	850

Rueda PO

Poliuretano inyectado

300 - 600 kg



VENTAJAS DEL ARO

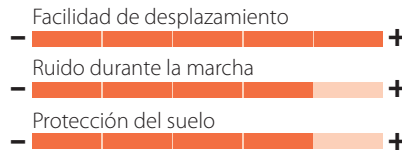

-25° a +80°

Más información en página 281

BLOQUEO DIRECCIONAL



Cojinete Eje

125	42	—
125	42	●●
150	42	—
150	42	●●
200	50	—
200	50	●●

Código	KG
2-0483	300
2-0484	300
2-0485	450
2-0486	450
2-0487	600
2-0488	600

Código	KG
2-0493	300
2-0494	300
2-0495	450
2-0496	450
2-0497	600
2-0498	600

Código	KG
-	-
-	-
2-1528	450
2-1529	450
2-1530	600
2-1531	600

Código	KG
2-3361	300
2-3362	300
2-3363	450
2-3364	450
2-3365	600
2-3366	600

Rueda HU

Poliuretano fundido

350 - 1.900 kg



VENTAJAS DEL ARO

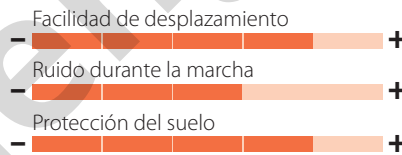

-20° a +60°

Más información en página 278

BLOQUEO DIRECCIONAL



Cojinete Eje

100	40	●●
125	40	●●
150	50	●●
200	50	●●
250E	50	●●
250H	50	●●
250A	75	●●
300H	50	●●
300A	75	●●

Código	KG
2-1751	350
2-1752	400
2-1753	800
2-1754	1.100
2-2294	1.100
2-1755	1.250
2-3431	1.500
4-1230	1.270
2-3432	1.900

Código	KG
2-1756	350
2-1757	400
2-1758	800
2-1759	1.100
2-2295	1.100
2-1760	1.250
2-3433	1.500
4-1231	1.270
2-3434	1.900

Código	KG
-	-
-	-
2-1761	800
2-1762	1.100
2-2296	1.100
2-1763	1.250
2-3742	1.500
2-1538	1.270
2-3743	1.900

Código	KG
2-3367	350
2-3368	400
2-3369	800
2-3370	1.100
2-3371	1.100
2-3372	1.250
2-3546	1.500
2-3373	1.270
2-3547	1.900

Rueda HUAB

Poliuretano fundido

600 - 800 kg



VENTAJAS DEL ARO

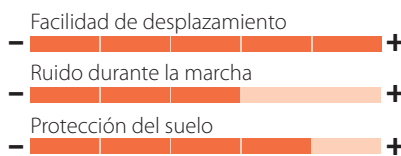

-20° a +60°

Más información en página 279

BLOQUEO DIRECCIONAL



Cojinete
Eje

150	50	
200	50	

Código



2-3534	600
2-3535	800

Código



2-3536	600
2-3537	800

Código



2-3538	600
2-3539	800

Código



2-3540	600
2-3541	800

▲ Rueda con banda de rodadura en forma balona. **Menor esfuerzo al giro y desplazamiento.**

Rueda NF

Nylon fundido extrafuerte

1.250 - 2.750 kg



VENTAJAS DEL ARO

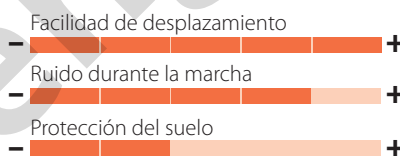

-30° a +80°

Más información en página 284

BLOQUEO DIRECCIONAL

NOVEDAD



Cojinete
Eje

100	55	
125	55	
150A	80	

Código



2-4418	1.250
2-4421	1.350
2-4424	2.750

Código



2-4419	1.250
2-4422	1.350
2-4425	2.750

Código



2-4420	1.250
2-4423	1.350
2-4426	2.750

Código



2-4487	1.250
2-4488	1.350
2-4489	2.750

Rueda FT

Nylon extrafuerte

400 - 1.250 kg



VENTAJAS DEL ARO

- Facilidad de desplazamiento
- Ruido durante la marcha
- Protección del suelo

-30° a +80°

Más información en página 284

BLOQUEO DIRECCIONAL



Cojinete Eje

100	32	—
100	32	●●
125	42	—
125	42	●●
150	45	—
150	45	●●
200	50	—
200	50	●●
250E	57	—
250E	57	●●
250H	57	—
250H	57	●●

Código	KG
2-0463	400
2-0464	400
2-0465	600
2-0466	600
2-0467	900
2-0468	900
2-0469	1.000
2-0470	1.000
2-2297	1.100
2-2298	1.100
2-0471	1.250
4-1056	1.250

Código	KG
2-0472	400
2-0473	400
2-0474	600
2-0475	600
2-0476	900
2-0477	900
2-0478	1.000
2-0479	1.000
2-2299	1.100
2-2300	1.100
2-0480	1.250
4-1065	1.250

Código	KG
-	-
-	-
-	-
-	-
2-1513	900
2-1514	900
2-1512	1.000
2-1519	1.000
2-2301	1.100
2-2302	1.100
2-1520	1.250
2-1521	1.250

Código	KG
2-3375	400
2-3376	400
2-3377	600
2-3378	600
2-3379	900
2-3380	900
2-3381	1.000
2-3382	1.000
2-3383	1.100
2-3384	1.100
2-3385	1.250
2-3386	1.250

Rueda TA

Acero

450 - 1.350 kg



VENTAJAS DEL ARO

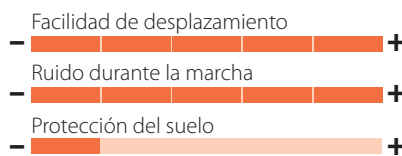

-90° a +600°

Más información en página 288

BLOQUEO DIRECCIONAL



Cojinete Eje

Diámetro	Altura	Cojinete
100	40	
125	40	
150	45	
150	45	
200	45	
200	45	
250E	50	
250H	50	

Código	KG
2-0516	450
2-0518	630
2-0519	1.175
2-0520	1.175
2-0521	1.250
2-0522	1.250
2-2303	1.250
2-0523	1.350

Código	KG
2-0525	450
2-0527	630
2-0528	1.175
2-0529	1.175
2-0530	1.250
2-0531	1.250
2-2304	1.250
2-0532	1.350

Código	KG
-	-
-	-
2-1540	1.175
2-1541	1.175
2-1542	1.250
2-1543	1.250
2-2305	1.250
2-1544	1.350

Código	KG
2-3387	450
2-3388	630
2-3389	1.175
2-3390	1.175
2-3391	1.250
2-3392	1.250
2-3393	1.250
2-3394	1.350

Las versiones con cojinetes de bolas, deben trabajar en un rango de temperatura: -40° a +150°

Para temperaturas superiores a 200° reducir carga (kg) un 40%

Accesorio protección pie rígido



Código

150	2-3624
200	2-3625
250	2-3656



Para \varnothing 250 Ancho banda rodadura 75 Consultar



Para solicitar la protección pie, añadir a la rueda solicitada el código correspondiente.

PROTECCIÓN PIE



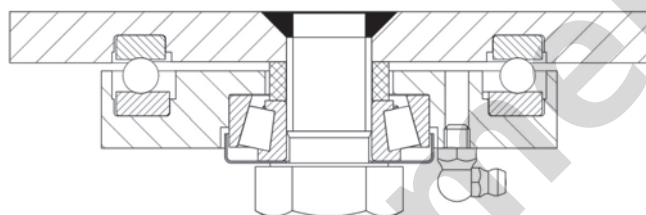

350 - 1.250 kg **150 a 250 mm**

- » Acabado pintado negro
- » Fabricadas según normas europeas EN 12532/12533

DETALLES DEL PRODUCTO

- ✓ Fabricada con acero soldado desde 8 m/m hasta 18 m/m de espesor.
- ✓ Cojinete superior construido mediante mecanización de precisión.
- ✓ Soporte con suspensión elástica mediante incorporación de doble muelle muy resistente, para altas cargas.
- ✓ Recorrido del muelle hasta 24,5 mm para una carga de 700kg.
- ✓ Especialmente diseñada para absorber por amortiguación: golpes, choques y desniveles.

Medidas Generales



	GIRAT *	FIJA *	GIRAT *				AGUJ	
150	150x110	150x110	105x80	10	-	246	-	129
160	150x110	150x110	105x80	10	-	251	-	134
200	150x110	150x110	105x80	10	-	271	-	154
250	150x110	150x110	105x80	10	-	320	-	188

* Detalle de planos de platina, ver página 22

Rueda DE

Goma elástica

350 - 500 kg



VENTAJAS DEL ARO

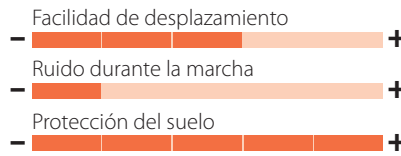

-20° a +70°

Más información en página 274



Cojinete Eje

160	50	
200	50	
250	50	

Código	KG
2-3178	350
2-3182	450
2-3186	500

Código	KG
2-3190	350
2-3194	450
2-3198	500

Código	KG
2-4047	350
2-4048	450
2-4049	500

Código	KG
2-4061	350
4-1565	450
4-0999	500

Rueda DEGB

Goma elástica gris

350 - 450 kg



VENTAJAS DEL ARO

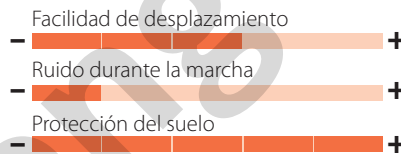

-20° a +70°

Más información en página 274

NOVEDAD



Cojinete Eje

160	50	
200	50	

Código	KG
2-4406	350
2-4409	450

Código	KG
2-4407	350
2-4410	450

Código	KG
2-4408	350
2-4411	450

Código	KG
4-1667	350
4-1668	450

Orden de carga

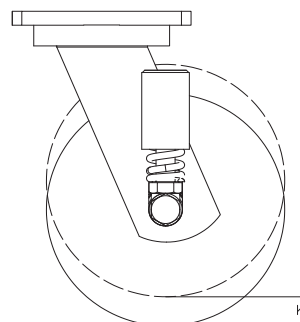

ORDENADO POR CARGA

Carga (kg)	Recorrido "h" mm
100	3,5
200	7,0
300	10,5
400	14,0
500	17,5
600	21,0
700	24,5

Rueda HG

Goma negra natural

400 - 700 kg



VENTAJAS DEL ARO

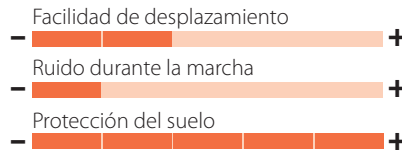

-20° a +60°

Más información en página 270



Cojinete Eje

150	50	
200	50	
250	50	

Código



2-3179	400
2-3183	600
2-3187	700

Código



2-3191	400
2-3195	600
2-3199	700

Código



2-4050	400
2-4051	600
2-4052	700

Código



4-1642	400
4-1643	600
4-0523	700

Rueda HU

Poliuretano fundido

800 - 1.250 kg



VENTAJAS DEL ARO

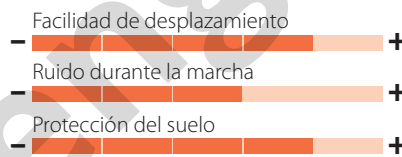

-20° a +60°

Más información en página 278



Cojinete Eje

150	50	
200	50	
250	50	

Código



2-3180	800
2-3184	1.100
2-3188	1.250

Código



2-3192	800
2-3196	1.100
2-3200	1.250

Código



2-4039	800
2-4040	1.100
2-4041	1.250

Código



4-1644	800
4-1645	1.100
2-1750	1.250

Rueda HUAB

Poliuretano fundido

600 - 800 kg



VENTAJAS DEL ARO

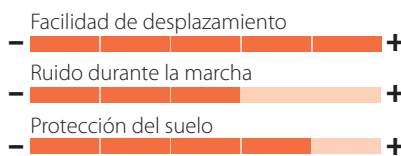

-20° a +60°

Más información en página 279



Cojinete Eje

150	50	
200	50	

Código



2-3542	600
2-3543	800

Código



2-3544	600
2-3545	800

Código



2-4042	600
2-4043	800

Código



2-4059	600
2-4060	800

▲ Rueda con banda de rodadura en forma balona. **Menor esfuerzo al giro y desplazamiento.**

Rueda FT

Nylon extrafuerte

900 - 1.250 kg



VENTAJAS DEL ARO

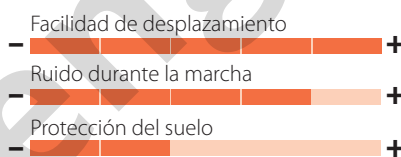

-30° a +80°

Más información en página 284



Cojinete Eje

150	45	
200	50	
250	57	

Código



2-3181	900
2-3185	1.000
2-3189	1.250

Código



2-3193	900
2-3197	1.000
2-3201	1.250

Código



2-4044	900
2-4045	1.000
2-4046	1.250

Código



4-0012	900
4-0016	1.000
4-0018	1.250

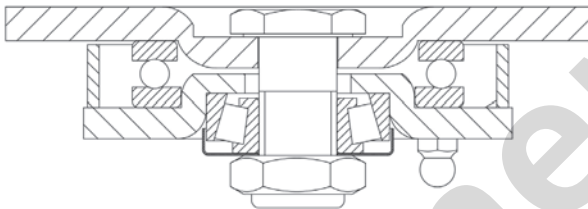

DETALLES DEL PRODUCTO

- ✓ Fabricada con acero soldado hasta 8 m/m de espesor.
- ✓ Soporte con suspensión elástica basculante mediante incorporación de muelle muy resistente.
- ✓ Recorrido de suspensión hasta 25 m/m para una carga de 140 kg.
- ✓ Especialmente diseñada para absorber por amortiguación: golpes, choques y desniveles en desplazamientos en velocidad.

KG 350 - 1.000 kg **150 a 250 mm**

- » Acabado pintado negro
- » Fabricadas según normas europeas EN 12532/12533

Medidas Generales

	GIRAT *	FIJA *	GIRAT *	GIRAT *	AGUJ	AGUJ	AGUJ	AGUJ
150	150x110	150x110	105x80	10	-	240	-	175
160	150x110	150x110	105x80	10	-	245	-	180
200	150x110	150x110	105x80	10	-	265	-	200
250	175x140	150x110	140x105	12	-	315	-	249

* Detalle de planos de platina, ver página 22

Rueda DE

Goma elástica

350 - 450 kg



VENTAJAS DEL ARO

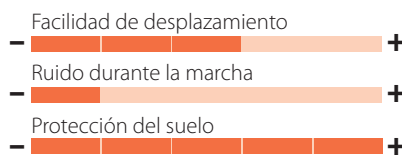

−20° a +70°

Más información en página 274



Cojinete Eje

160	50	
200	50	

Código



2-3960 350

2-3961 450

Código



2-3962 350

2-3963 450

Código



2-3964 350

2-3965 450

Código



4-0997 350

4-0998 450

Rueda DEGB

Goma elástica gris

350 - 450 kg



VENTAJAS DEL ARO

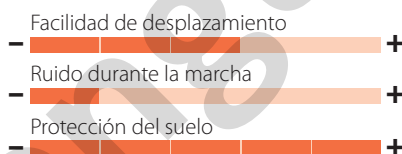

−20° a +70°

Más información en página 274

NOVEDAD



Cojinete Eje

160	50	
200	50	

Código



2-4412 350

2-4415 450

Código



2-4413 350

2-4416 450

Código



2-4414 350

2-4417 450

Código



4-1659 350

4-1660 450

Orden de carga

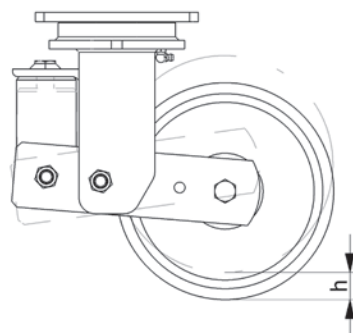

ORDENADO POR CARGA

Carga (kg)	Recorrido "h" mm
60	5
80	10
100	15
120	20
140	25

Rueda HG

Goma negra natural

400 - 750 kg



VENTAJAS DEL ARO

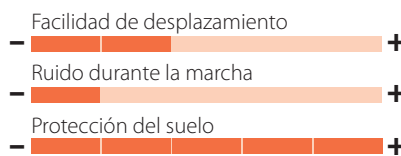

-20° a +60°

Más información en página 270



Cojinete
Eje

150	50	
200	50	
250	75	

Código



KG

2-3930	400
2-3931	600
2-3936	750

Código



KG

2-3932	400
2-3933	600
2-3937	750

Código



KG

2-3934	400
2-3935	600
2-3938	750

Código



KG

4-0518	400
4-0235	600
4-1639	750

Rueda AUGB

Poliuretano verde fundido

550 - 700 kg



VENTAJAS DEL ARO

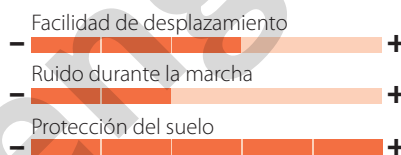

-20° a +60°

Más información en página 280



Cojinete
Eje

160	50	
200	50	

Código



KG

2-3948	550
2-3949	700

Código



KG

2-3950	550
2-3951	700

Código



KG

2-3952	550
2-3953	700

Código



KG

4-1654	550
4-1641	700

▲ Rueda de poliuretano verde. **Mayor elasticidad.**

Rueda AUAGB

Poliuretano verde fundido

500 - 650 kg



VENTAJAS DEL ARO

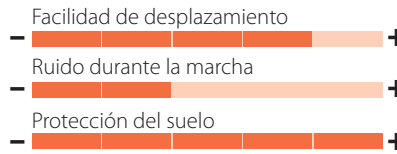

−20° a +60°

Más información en página 280

NOVEDAD



Cojinete Eje

160	50	
200	50	

Código



2-4400	500
2-4403	650

Código



2-4401	500
2-4404	650

Código



2-4402	500
2-4405	650

Código



4-1661	500
4-1662	650

▲ Rueda con banda de rodadura en forma balona. **Menor esfuerzo al giro y desplazamiento.**

Rueda HU

Poliuretano fundido

800 - 1.000 kg



VENTAJAS DEL ARO

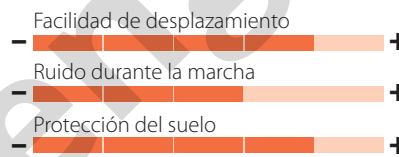

−20° a +60°

Más información en página 270



Cojinete Eje

150	50	
200	50	
250	75	

Código



2-3939	800
2-3940	1.000
2-3945	1.000

Código



2-3941	800
2-3942	1.000
2-3946	1.000

Código



2-3943	800
2-3944	1.000
2-3947	1.000

Código



2-1748	800
2-1749	1.100
2-3437	1.600

Rueda AUAB

Poliuretano fundido

600 - 750 kg



VENTAJAS DEL ARO

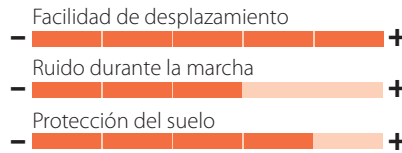

-20° a +60°

Más información en página 279



Cojinete Eje

160	50	
200	50	

Código

KG

2-4053	600
2-4056	750

Código

KG

2-4054	600
2-4057	750

Código

KG

2-4055	600
2-4058	750

Código

KG

2-3992	600
2-3993	750

▲ Rueda con banda de rodadura en forma balona. **Menor esfuerzo al giro y desplazamiento.**

Rueda FT

Nylon extrafuerte

900 - 1.000 kg



VENTAJAS DEL ARO

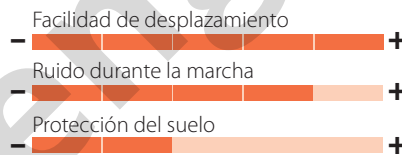

-30° a +80°

Más información en página 284



Cojinete Eje

150	45	
200	50	

Código

KG

2-3954	900
2-3955	1.000

Código

KG

2-3956	900
2-3957	1.000

Código

KG

2-3958	900
2-3959	1.000

Código

KG

4-0011	900
4-0015	1.000

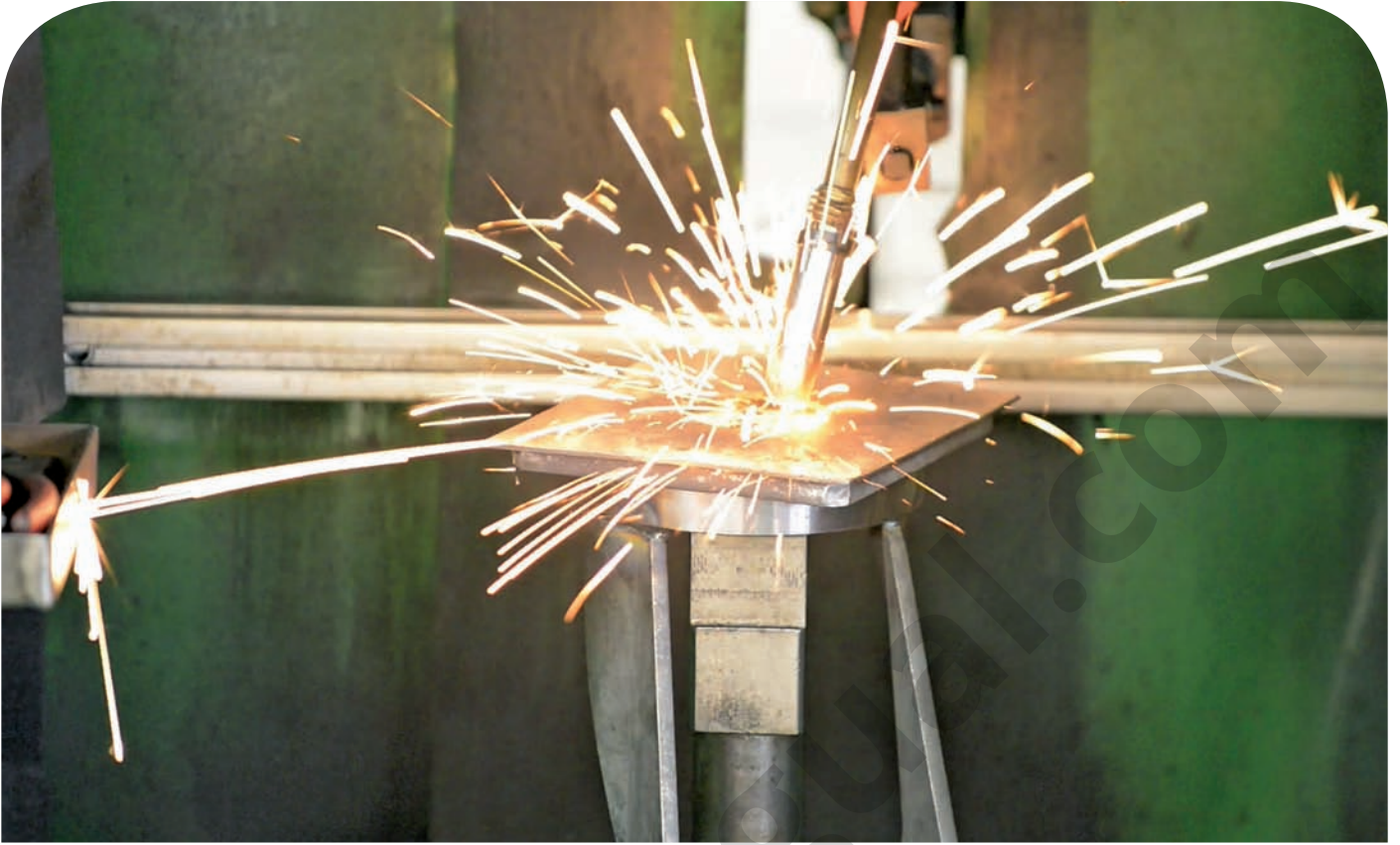

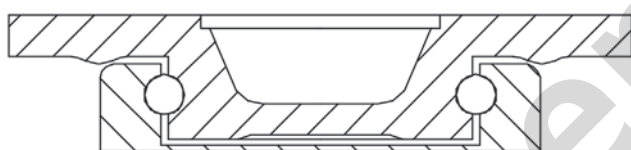

DETALLES DEL PRODUCTO

- ✓ Fabricada con acero, hasta 8 m/m de espesor.
- ✓ Cabezal giratorio con bolas de acero de gran dureza diseñado para soportar esfuerzos radiales y laterales.
- ✓ Engrasador en el cabezal.
- ✓ Modelo construido especialmente para: Industrias químicas, mataderos, textiles, etc.

400 - 1.270 kg **150 a 250 mm**

- » Acabado pintado negro
- » Fabricadas según normas europeas EN 12532/12533

Medidas Generales



150	150x110	150x110	105x80	12	-	200	-	148
200	150x110	150x110	105x80	12	-	250	-	185
250	150x110	150x110	105x80	12	-	300	-	188

* Detalle de planos de platina, ver página 22

Rueda HG

Goma negra natural

400 - 700 kg



VENTAJAS DEL ARO

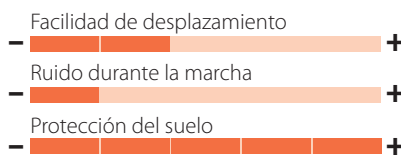

-20° a +60°

Más información en página 270



Cojinete Eje

150	50	
150	50	
200	50	
250	50	

Código



2-1968	400
2-1969	600
2-1970	700

Código



2-1971	400
2-1972	600
2-1973	700

Código



4-0518	400
4-0235	600
4-0523	700

Rueda PO

Poliuretano inyectado

450 - 600 kg



VENTAJAS DEL ARO

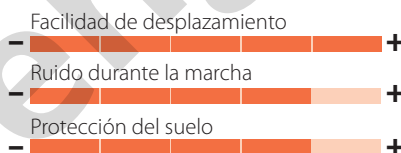

-25° a +80°

Más información en página 281



Cojinete Eje

150	42	
150	42	
200	50	
200	50	

Código



4-0935	450
4-0937	450
4-0939	600
4-0941	600

Código



4-0936	450
4-0938	450
4-0940	600
4-0942	600

Código



4-0482	450
4-0484	450
4-0486	600
4-0488	600

Rueda HU

Poliuretano fundido

800 - 1.250 kg



VENTAJAS DEL ARO

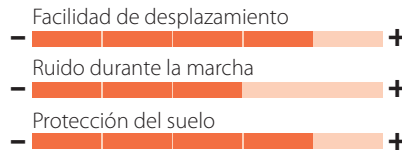

-20° a +60°

Más información en página 278



		Cojinete Eje	
150	50		
200	50		
250	50		

Código	KG
4-0150	800
4-0151	1.100
4-0152	1.250

Código	KG
4-0166	800
4-0167	1.100
4-0172	1.250

Código	KG
2-1748	800
2-1749	1.100
2-1750	1.250

Rueda FT

Nylon extrafuerte

900 - 1.250 kg



VENTAJAS DEL ARO

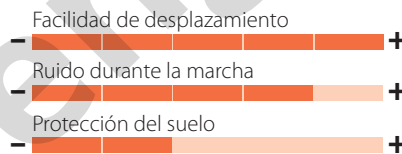

-30° a +80°

Más información en página 284



		Cojinete Eje	
150	45		
150	45		
200	50		
200	50		
250	57		
250	57		

Código	KG
4-0143	900
4-0144	900
4-0145	1.000
4-0146	1.000
4-0147	1.250
4-0148	1.250

Código	KG
4-0161	900
4-0162	900
4-0163	1.000
4-0164	1.000
4-0168	1.250
4-0169	1.250

Código	KG
4-0009	900
4-0011	900
4-0013	1.000
4-0015	1.000
4-0017	1.250
4-0018	1.250

Rueda TA

Acero

1.090 - 1.270 kg



VENTAJAS DEL ARO

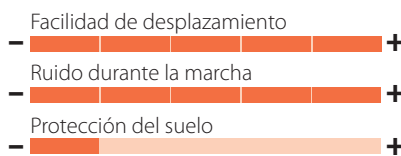

-90° a +600°

Más información en página 288



Cojinete Eje

Diámetro	Altura	Cojinete Eje
150	45	—
150	45	●●
200	45	—
200	45	●●
250	50	●●

Código	KG
4-1133	1.090
4-0378	1.090
4-1134	1.180
4-0380	1.180
4-0382	1.270

Código	KG
4-1135	1.090
4-0379	1.090
4-1136	1.180
4-0381	1.180
4-0383	1.270

Código	KG
4-0559	1.175
4-0560	1.175
4-0562	1.250
4-0563	1.250
4-0568	1.350

Las versiones con cojinetes de bolas, deben trabajar en un rango de temperatura: -40° a +150°

Para temperaturas superiores a 200° reducir carga (kg) un 40%



NOVEDAD



Ruedas niveladas



↑ Opción de nivelar hasta 15 mm.

50 - 1.500 kg 42 a 100 mm

» Acabado pintado y cincado

DETALLES DEL PRODUCTO

- ✓ Buena resistencia a la abrasión y flexión.
- ✓ Pie de caucho sintético reforzado.
- ✓ Horquilla de fundición de aluminio.
- ✓ Especialmente diseñadas para pequeños desplazamientos de maquinaria voluminosa.

Medidas Generales

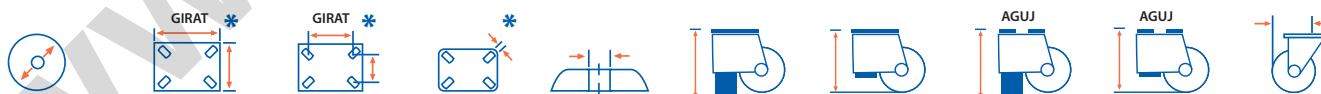

42	63,5x63,5	49x49	6	M8	78	68	81	71	50
50	74x74	58x58	6	M12	93	83	97	87	63
63	91x91	70x70	8	M12	117	102	120	105	78
75	95x95	70x70	10	M16	133	121	133	121	91
75A	96x96	70x70	10	M16	136	124	133	121	91
100	100x100	70x70	12	-	146	131	-	-	118



* Detalle de planos de platina, ver página 23

Serie FM

Aro poliamida

50 - 1.500 kg

NOVEDAD



		Cojinete Eje
42	19	—
50	24	—



Código	
2-4552	50
2-4554	250



Código	
2-4553	50
2-4555	250



		Cojinete Eje
63	27	—
75	30	—



Código	
2-4556	500
2-4558	750



Código	
2-4557	500
2-4559	750



		Cojinete Eje
75A	30	—



Código	
2-4560	1.000



Código	
2-4561	1.000

		Cojinete Eje
100	54	—



Código	
2-4562	1.500

RUEDAS CON MUELLE PARA PUERTAS

Serie JA

Caucho duro

50 kg

NOVEDAD

**ESPECIAL
PARA PUERTAS
DE EXTERIOR**



–30° a +80°

Dureza 90-95° shore A

- Acabado soporte: cincado blanco.
- Rueda en caucho duro.



Cojinete
Eje

Código



100

30

4-1665

50

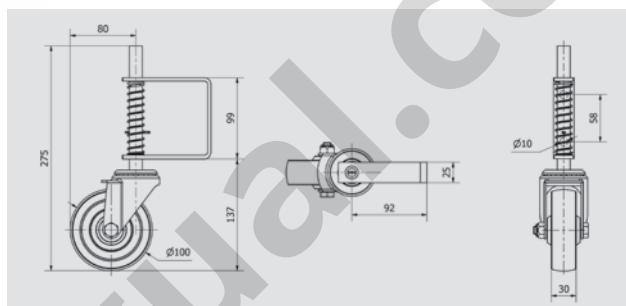

Aro de goma HG

75 kg

NOVEDAD

**ESPECIAL
PARA PUERTAS
DE EXTERIOR**



–30° a +80°

Dureza 85° shore A

- Acabado soporte: pintado negro.
- Rueda de goma elástica y núcleo de acero.



Cojinete
Eje

Código



100

50

4-1666

75

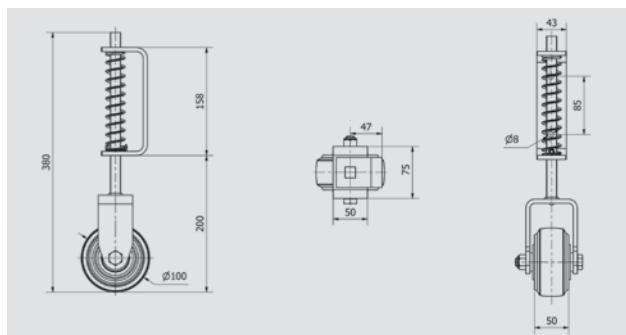



NOTA: Ruedas especialmente diseñadas para puertas de gran tamaño. No están diseñadas para soportar todo el peso de la puerta (50/75 kg.)

Freno TLC

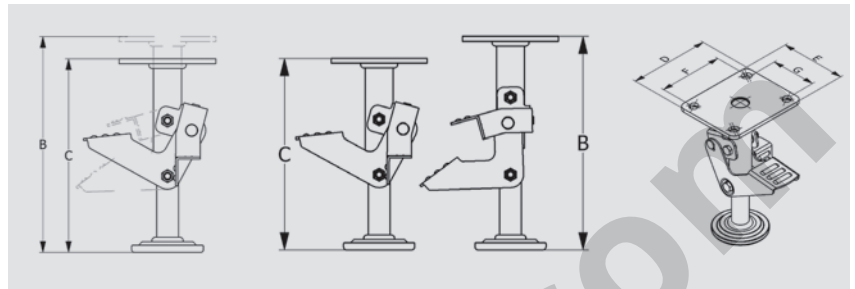
ACERO CINCADO

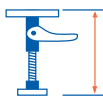

Código	Posición pedal palancas			D	E	F x G
4-0572	Derecha	246 (B)	220 (C)	135	110	102x82/108x78

✓ El freno TLC está diseñado para colocarlo, debajo de los contenedores, la cara superior de la platina debe colocarse entre 239 y 243 mm. del suelo.

- ✓ Gran robustez.
- ✓ Pie en goma antideslizante.

Freno TLCH

ACERO PINTADO NEGRO

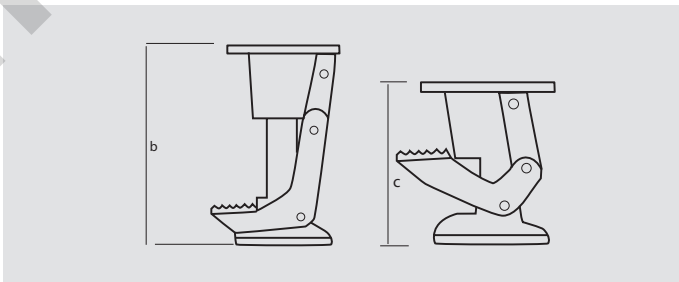

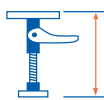
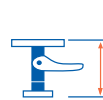
Código			D x E	F x G	H
4-0569	208 (B)	162 (C)	152X114	127X63,5	12

✓ El freno TLCH está diseñado para colocarlo, debajo de los contenedores, la cara superior de la platina debe colocarse a 200 mm. del suelo.

- ✓ Gran robustez.
- ✓ Pie en goma antideslizante.



Ruedas de alta y media capacidad de carga

Hasta 1.000 kg
por rueda

ÍNDICE

- Serie **SLR** pág. 72
- Serie **SL** pág. 80
- Serie **TV** pág. 84
- Serie **TVC** pág. 94
- Serie **ZVR** pág. 98
- Serie **ZV** pág. 106
- Serie **61** pág. 138
- Serie **LP** pág. 142

* AMPLIAMOS
GAMA

* AMPLIAMOS
GAMA

NOVEDAD



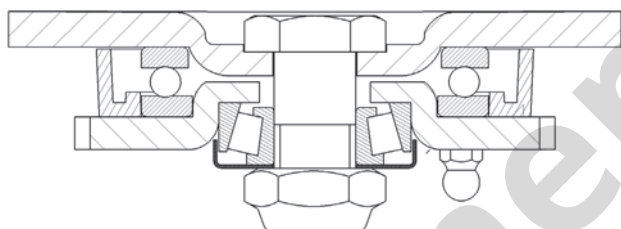

DETALLES DEL PRODUCTO

- ✓ Fabricada con acero soldado desde 6 m/m hasta 8 m/m de espesor.
- ✓ Doble cabezal giratorio, el superior de bolas grandes de acero y el inferior de precisión que facilita los esfuerzos de giro, radiales y axiales.
- ✓ Modelo construido especialmente para uso en: carretillas grandes con empuje mecánico, mantenimiento de factorías, industrias metalúrgicas...

400 - 1.000 kg **82 a 200 mm**

- » Acabado cincado blanco
- » Fabricadas según normas europeas EN 12532

Medidas Generales



	GIRAT *	FIJA *	GIRAT *				AGUJ	
82	150x110	150x110	125x70/105x80	10	-	131	-	71
85	150x110	150x110	125x70/105x80	10	-	132	-	72
150	150x110	150x110	125x70/105x80	10	-	200	-	124
160	150x110	150x110	125x70/105x80	10	-	205	-	129
200	150x110	150x110	125x70/105x80	10	-	245	-	158

* Detalle de planos de platina, ver página 24

Rueda HG

Goma negra natural

400 - 600 kg



VENTAJAS DEL ARO

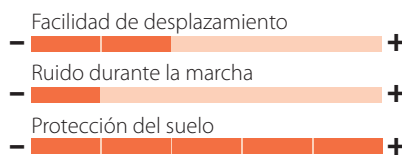

-20° a +60°

Más información en página 270



Cojinete Eje

150	50	
200	50	

Código	KG
2-3641	400
2-3642	600

Código	KG
2-3643	400
2-3644	600

Código	KG
2-3645	400
2-3646	600

Código	KG
4-0518	400
4-0235	600

Rueda HU

Poliuretano fundido

800 - 1.000 kg



VENTAJAS DEL ARO

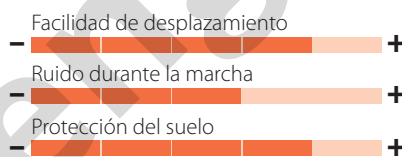

-20° a +60°

Más información en página 278



Cojinete Eje

150	50	
200	50	

Código	KG
2-3663	800
2-3664	1.000

Código	KG
2-3665	800
2-3666	1.000

Código	KG
2-3667	800
2-3668	1.000

Código	KG
2-1748	800
2-1749	1.100

Rueda AUSB

Poliuretano blanco fundido

600 - 750 kg



VENTAJAS DEL ARO

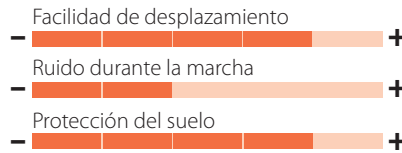

-20° a +60°

Más información en página 280



Cojinete Eje

160	50	
200	50	

Código



2-4184	600
2-4191	750

Código



2-4185	600
2-4192	750

Código



2-4186	600
2-4193	750

Código



4-1657	600
4-1658	750

▲ Ruedas **recomendadas** para desplazamientos **en velocidad (hasta 16 Km/h)**

▲ Cargas recomendadas según velocidad: 6 km/h -20%, 10 km/h -40%, 16 km/h -60%

Rueda PO

Poliuretano inyectado

450 - 600 kg



VENTAJAS DEL ARO

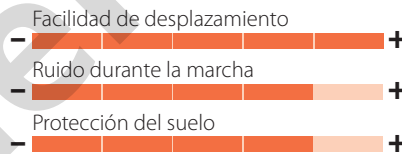

-25° a +80°

Más información en página 281



Cojinete Eje

150	42	
150	42	
200	50	
200	50	

Código



2-3647	450
2-3648	450
2-3657	600
2-3658	600

Código



2-3649	450
2-3650	450
2-3659	600
2-3660	600

Código



2-3651	450
2-3652	450
2-3661	600
2-3662	600

Código



4-0482	450
4-0484	450
4-0486	600
4-0488	600

Rueda FT

Nylon extrafuerte

900 - 1.000 kg



VENTAJAS DEL ARO

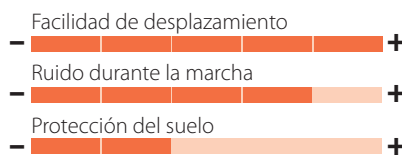

🌡️ -30° a +80°

Más información en página 284



Cojinete Eje

150	45	—
150	45	●●
200	50	—
200	50	●●

Código	KG
2-3669	900
2-3670	900
2-3671	1.000
2-3672	1.000

Código	KG
2-3673	900
2-3674	900
2-3675	1.000
2-3676	1.000

Código	KG
2-3677	900
2-3678	900
2-3679	1.000
2-3680	1.000

Código	KG
4-0009	900
4-0011	900
4-0013	1.000
4-0015	1.000

Rueda TA

Acero

1.000 kg



VENTAJAS DEL ARO

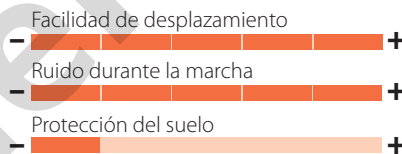

🌡️ -90° a +600°

Más información en página 288



Cojinete Eje

150	45	—
150	45	●●
200	45	—
200	45	●●

Código	KG
2-3681	1.000
2-3682	1.000
2-3683	1.000
2-3684	1.000

Código	KG
2-3685	1.000
2-3686	1.000
2-3687	1.000
2-3688	1.000

Código	KG
2-3698	1.000
2-3699	1.000
2-3700	1.000
2-3701	1.000

Código	KG
4-0559	1.175
4-0560	1.175
4-0562	1.250
4-0563	1.250

Las versiones con cojinetes de bolas, deben trabajar en un rango de temperatura: -40° a +150°

Para temperaturas superiores a 200° reducir carga (kg) un 40%

Rueda HUAB

Poliuretano fundido

600 - 800 kg



VENTAJAS DEL ARO

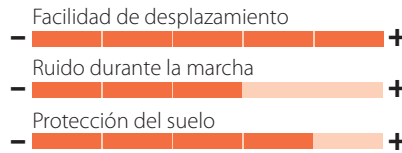

-20° a +60°

Más información en página 279



Cojinete Eje

150	50	
200	50	

Código



2-3724	600
2-3725	800

Código



2-3726	600
2-3727	800

Código



2-3728	600
2-3729	800

Código



2-3313	600
2-3314	800

▲ Rueda con banda de rodadura en forma balona. **Menor esfuerzo al giro y desplazamiento.**

Rodillo VN

Núcleo metálico y banda de poliuretano vulcanizado

600 kg



VENTAJAS DEL ARO

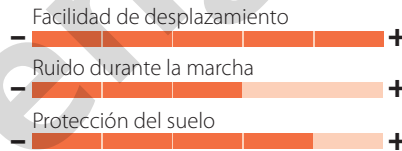

-25° a +80°

Más información en página 292



Cojinete Eje

85	60	
----	----	--

Código



2-3996	600
--------	-----

Código



2-3999	600
--------	-----

Código



2-1504	600
--------	-----

Rodillo KI

Núcleo nylon y banda de poliuretano inyectado

450 kg



VENTAJAS DEL ARO

- Facilidad de desplazamiento
- Ruido durante la marcha
- Protección del suelo

-25° a +80°

Más información en página 292



Cojinete Eje

82

60



Código



2-3995

450

Código



2-3998

450

Código



4-1538

450

Rodillo KN

Nylon extrafuerte

650 kg



VENTAJAS DEL ARO

- Facilidad de desplazamiento
- Ruido durante la marcha
- Protección del suelo

-25° a +80°

Más información en página 293



Cojinete Eje

82

60



Código



2-3994

650

Código



2-3997

650

Código



4-1304

650

Accesorio protección pie flexible



Código

150	2-4036
160	2-4036
200	2-4037



Para solicitar la protección pie, añadir a la rueda solicitada el código correspondiente.

**PROTECCIÓN
PIE**





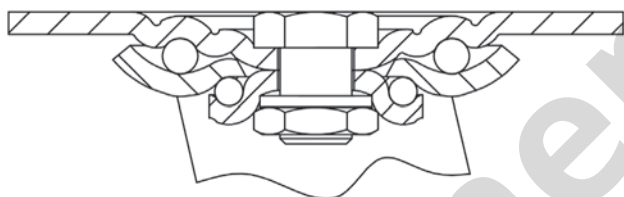

200 - 600 kg **100 a 200 mm**

- » Acabado bicromatizado amarillo de gran resistencia
- » Fabricadas según normas europeas EN 12532

DETALLES DEL PRODUCTO

- ✓ Fabricada con acero hasta 5 m/m de espesor.
- ✓ Cabezal giratorio con cojinete de doble hilera de bolas de acero, sobre vías endurecidas.
- ✓ Modelo diseñado especialmente para carretillas con empuje mecánico, manutención en factorías, servicios públicos, industrias metalúrgicas, químicas, etc.

Medidas Generales



100	135x110	135x110	105x80	10	-	140	-	83
125	135x110	135x110	105x80	10	-	165	-	102
150	135x110	135x110	105x80	10	-	190	-	120
200	135x110	135x110	105x80	10	-	241	-	154

* Detalle de planos de platina, ver página 24

Rueda HG

Goma negra natural

200 - 600 kg



VENTAJAS DEL ARO

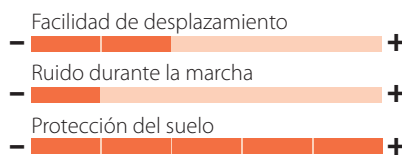

-20° a +60°

Más información en página 270



Cojinete Eje

100	38	
125	38	
150	50	
200	50	

Código



4-0784	200
4-0791	250
2-1982	400
2-1983	600

Código



4-0862	200
4-0795	250
2-1986	400
2-1987	600

Código



4-1193	200
4-1194	250
4-1615	400
4-1616	600

Código



4-0514	200
4-0516	250
4-0518	400
4-0235	600

Rueda PO

Poliuretano inyectado

300 - 600 kg



VENTAJAS DEL ARO

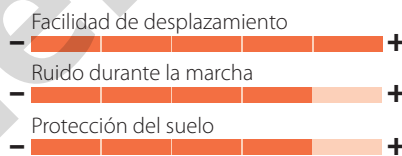

-25° a +80°

Más información en página 281



Cojinete Eje

125	42	
125	42	
150	42	
150	42	
200	50	
200	50	

Código



4-0951	300
4-0953	300
4-0955	450
4-0957	450
4-0959	600
4-0961	600

Código



4-0952	300
4-0954	300
4-0956	450
4-0958	450
4-0960	600
4-0962	600

Código



4-1210	300
4-1211	300
4-1611	450
4-1612	450
4-1613	600
4-1614	600

Código



4-0480	300
4-0481	300
4-0482	450
4-0484	450
4-0486	600
4-0488	600

Rueda HU

Poliuretano fundido

350 - 600 kg



VENTAJAS DEL ARO

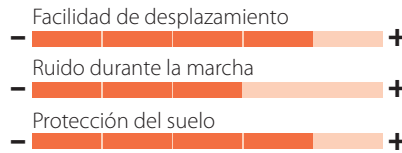

-20° a +60°

Más información en página 278



	Cojinete	Eje
100	40	
125	40	
150	50	
200	50	

Código	KG
4-0785	350
4-0792	400
4-0863	600
4-0807	600

Código	KG
4-0788	350
4-0796	400
4-0803	600
4-0811	600

Código	KG
4-1216	350
4-1217	400
4-1617	600
4-1618	600

Código	KG
2-1746	350
2-1747	400
2-1748	800
2-1749	1.100

Rueda FT

Nylon extrafuerte

400 - 600 kg



VENTAJAS DEL ARO

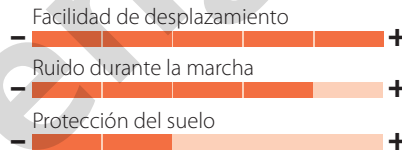

-30° a +80°

Más información en página 284



	Cojinete	Eje
100	32	
100	32	
125	42	
125	42	
150	45	
150	45	
200	50	
200	50	

Código	KG
4-0812	400
4-0786	400
4-0813	500
4-0793	500
4-0814	600
4-0800	600
4-0815	600
4-0808	600

Código	KG
4-0816	400
4-0789	400
4-0817	500
4-0797	500
4-0818	600
4-0804	600
4-0819	600
4-0847	600

Código	KG
4-1200	400
4-1201	400
4-1202	500
4-1203	500
4-1619	600
4-1620	600
4-1621	600
4-1622	600

Código	KG
4-0004	400
4-0005	400
4-0007	600
4-0008	600
4-0009	900
4-0011	900
4-0013	1.000
4-0015	1.000

Rueda TA

Acero

450 - 600 kg



VENTAJAS DEL ARO

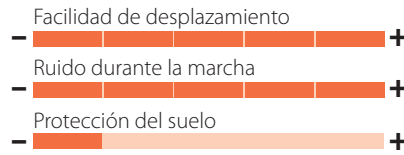

-90° a +600°

Más información en página 288



Cojinete Eje

100	40	
125	40	
150	45	
150	45	
200	45	
200	45	

Código	KG
4-0787	450
4-0794	500
4-0855	600
4-0801	600
4-0859	600
4-0809	600

Código	KG
4-0790	450
4-0798	500
4-0857	600
4-0805	600
4-0861	600
4-0846	600

Código	KG
4-0556	450
4-0558	630
4-0559	1.175
4-0560	1.175
4-0562	1.250
4-0563	1.250

Las versiones con cojinetes de bolas, deben trabajar en un rango de temperatura: -40° a +150°

Para temperaturas superiores a 200° reducir carga (kg) un 40%

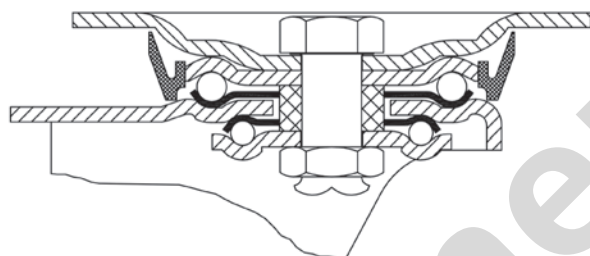
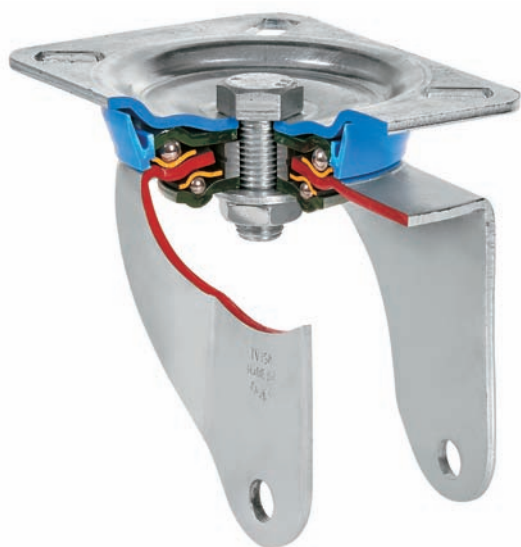

DETALLES DEL PRODUCTO

- ✓ Fabricada con chapa de acero embutido hasta 5 m/m de espesor.
- ✓ Doble rodamiento a bolas reforzado con platillos intermedios y pistas de rodadura endurecidas.
- ✓ Protector anti-polvo en el cojinete del soporte.
- ✓ Modelo diseñado especialmente para: Carretillas industriales, manutención de factorías, contenedores de trabajos duros, industrias metalúrgicas, químicas, servicios públicos, etc.

110 - 800 kg **80 a 200 mm**

- » Acabado cincado brillante de alta resistencia al óxido
- » Fabricadas según normas europeas EN 12532

Medidas Generales

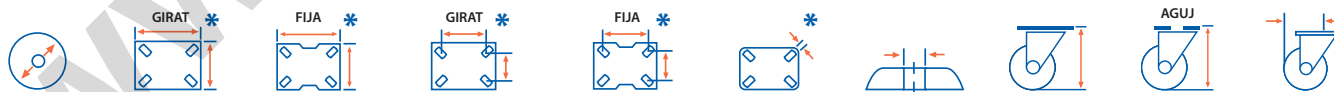

Diámetro	Platina Girat *	Platina Fija *	Platina Girat *	Platina Fija *	Altura	Altura sin eje	Altura con eje	Altura con eje	Diámetro eje
80	106x86	106x86	86/80x60	80x60	8	-	124	-	64
100	106x86	106x86	86/80x60	80x60	8	-	140	-	81
125	139x110	136x116	105x80	105x80	10	-	164	-	115
150	139x110	136x116	105x80	105x80	10	-	206	-	130
160	139x110	136x116	105x80	105x80	10	-	211	-	135
200	139x110	136x116	105x80	105x80	10	-	251	-	155

* Detalle de planos de platina, ver página 24

Rueda DE

Goma elástica

200 - 450 kg



VENTAJAS DEL ARO

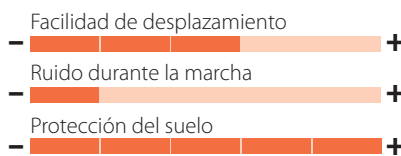

🌡️ -20° a +70°

Más información en página 274



Cojinete Eje

100	40	●●
125	40	●●
160	50	●●
200	50	●●

Código



2-2194	200
2-1992	250
2-1993	350
2-1994	450

Código



2-2195	200
2-1995	250
2-1996	350
2-1997	450

Código



2-2193	200
2-1998	250
2-1999	350
2-2000	450

Código



4-0995	200
4-0996	250
4-0997	350
4-0998	450

Rueda TPG

Goma negra natural

110 - 280 kg



VENTAJAS DEL ARO

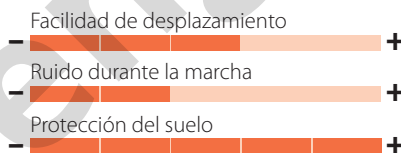

🌡️ -20° a +60°

Más información en página 276



Cojinete Eje

80	35	—
80	35	▨
100	35	—
100	35	▨
125	44	—
125	44	●●
150	50	—
150	50	●●

Código



2-0001	110
2-1254	110
2-0002	130
2-1255	130
2-0003	200
2-0533	200
2-0004	280
2-0535	280

Código



2-0007	110
2-1256	110
2-0008	130
2-1257	130
2-0009	200
2-0537	200
2-0010	280
2-0539	280

Código



2-1606	110
2-1607	110
2-1608	130
2-1609	130
2-1610	200
2-1611	200
2-1631	280
2-1632	280

Código



2-0059	110
2-1226	110
2-0060	130
2-1251	130
2-0061	200
2-0785	200
2-0062	280
2-0786	280

Rueda HG

Goma negra natural

250 - 600 kg



VENTAJAS DEL ARO

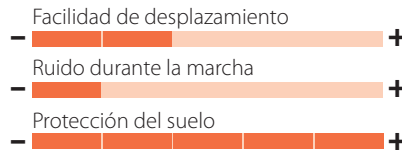

-20° a +60°

Más información en página 270



Cojinete
Eje

Cojinete	Eje
125	38
150	50
200	50

Código	KG
2-2046	250
2-2049	400
2-2052	600

Código	KG
2-2047	250
2-2050	400
2-2053	600

Código	KG
2-2048	250
2-2051	400
2-2054	600

Código	KG
4-0516	250
4-0518	400
4-0235	600

Rueda PO

Poliuretano inyectado

150 - 600 kg



VENTAJAS DEL ARO

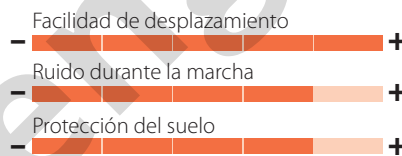

-25° a +80°

Más información en página 281



* **AMPLIAMOS GAMA**



Cojinete
Eje

Cojinete	Eje
80	32
80	32
100	33
100	33
125	42
125	42
150	42
150	42
200	50
200	50

Código	KG
* 2-4670	150
* 2-4630	150
2-0303	200
2-0311	200
2-0305	300
2-0313	300
2-0307	450
2-0315	450
2-0309	600
2-0317	600

Código	KG
* 2-4671	150
* 2-4631	150
2-0304	200
2-0312	200
2-0306	300
2-0314	300
2-0308	450
2-0316	450
2-0310	600
2-0318	600

Código	KG
* 2-4672	150
* 2-4632	150
2-1612	200
2-1613	200
2-1614	300
2-1615	300
2-1633	450
2-1634	450
2-0966	600
2-0967	600

Código	KG
* 2-4673	150
* 2-4629	150
2-1443	200
4-0479	200
4-0480	300
4-0481	300
4-0482	450
4-0484	450
4-0486	600
4-0488	600

Rueda HU

Poliuretano fundido

400 - 800 kg



VENTAJAS DEL ARO

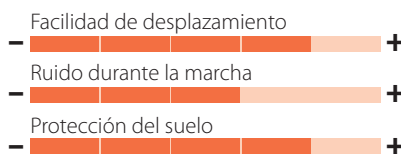

-20° a +60°

Más información en página 278



Cojinete
Eje

125	40	
150	50	
200	50	

Código	KG
2-2055	400
2-1788	750
2-1842	800

Código	KG
2-2056	400
2-1789	750
2-1844	800

Código	KG
2-2057	400
2-1845	750
2-1846	800

Código	KG
2-1747	400
2-1748	800
2-1749	1100

Rueda HUAB

Poliuretano fundido

600 - 800 kg



VENTAJAS DEL ARO

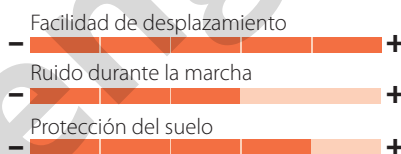

-20° a +60°

Más información en página 279



Cojinete
Eje

150	50	
200	50	

Código	KG
2-3528	600
2-3529	800

Código	KG
2-3530	600
2-3531	800

Código	KG
2-3532	600
2-3533	800

Código	KG
2-3313	600
2-3314	800

▲ Rueda con banda de rodadura en forma balona. **Menor esfuerzo al giro y desplazamiento.**

Rueda AUB

Poliuretano fundido

400 - 800 kg



VENTAJAS DEL ARO

- Facilidad de desplazamiento
- Ruido durante la marcha
- Protección del suelo

-20° a +60°

Más información en página 279

*** AMPLIAMOS GAMA**



		Cojinete Eje
125	40	
160	50	
200	50	

Código	KG
* 2-4517	400
2-3607	600
2-3608	800

Código	KG
* 2-4518	400
2-3609	600
2-3610	800

Código	KG
* 2-4519	400
2-3611	600
2-3612	800

Código	KG
* 2-4520	400
2-2548	600
2-2549	800

Rueda AUAB

Poliuretano fundido

550 - 750 kg



VENTAJAS DEL ARO

- Facilidad de desplazamiento
- Ruido durante la marcha
- Protección del suelo

-20° a +60°

Más información en página 279



		Cojinete Eje
160	50	
200	50	

Código	KG
2-3976	550
2-3989	750

Código	KG
2-3977	550
2-3990	750

Código	KG
2-3978	550
2-3991	750

Código	KG
2-3992	550
2-3993	750

▲ Rueda con banda de rodadura en forma balona. **Menor esfuerzo al giro y desplazamiento.**

Rueda TN

Nylon blanco

250 - 650 kg



VENTAJAS DEL ARO

- Facilidad de desplazamiento +
- Ruido durante la marcha +
- Protección del suelo +

🌡️ -30° a +80°

Más información en página 285



Cojinete Eje

80	35	—
80	35	▬▬▬
100	35	▬▬▬
100	35	▬▬▬
125	45	▬▬▬
125	45	●●
150	45	▬▬▬
150	45	●●
200	50	▬▬▬
200	50	●●

Código	KG
2-0019	250
2-0211	250
2-0020	300
2-0213	300
2-0021	350
2-0215	350
2-0022	600
2-0217	600
2-0023	650
2-0219	650

Código	KG
2-0024	250
2-0212	250
2-0025	300
2-0214	300
2-0026	350
2-0216	350
2-0027	600
2-0218	600
2-0098	650
2-0220	650

Código	KG
2-1616	250
2-1617	250
2-1618	300
2-1619	300
2-1620	350
2-1621	350
2-1635	600
2-1636	600
2-0947	650
2-0948	650

Código	KG
2-0067	250
2-0159	250
2-0068	300
2-0160	300
2-0069	350
2-0163	350
2-0070	650
2-0164	650
2-0071	750
2-0165	750

Rueda FT

Nylon extrafuerte

300 - 800 kg



VENTAJAS DEL ARO

- Facilidad de desplazamiento +
- Ruido durante la marcha +
- Protección del suelo +

🌡️ -30° a +80°

Más información en página 284



Cojinete Eje

80	32	—
100	32	▬▬▬
100	32	●●
125	42	▬▬▬
125	42	●●
150	45	▬▬▬
150	45	●●
200	50	▬▬▬
200	50	●●

Código	KG
2-1797	300
2-1798	400
2-1799	400
2-1800	600
2-1801	600
2-1802	750
2-1803	750
2-1806	800
2-1807	800

Código	KG
2-1808	300
2-1809	400
2-1810	400
2-1811	600
2-1812	600
2-1813	750
2-1814	750
2-1817	800
2-1818	800

Código	KG
2-1819	300
2-1820	400
2-1821	400
2-1822	600
2-1823	600
2-1824	750
2-1825	750
2-1828	800
2-1829	800

Código	KG
4-0003	300
4-1535	400
4-0005	400
4-0007	600
4-0008	600
4-0009	900
4-0011	900
4-0013	1.000
4-0015	1.000

Rueda TD

Resina extrafuerte

280 - 800 kg



VENTAJAS DEL ARO

- Facilidad de desplazamiento **+**
- Ruido durante la marcha **+**
- Protección del suelo **+**

-40° a +200°

Más información en página 288



Cojinete
Eje

Cojinete	Eje	
80	28	---
100	32	---
125	37	---
150	42	---
200	50	---

Código	KG
2-0011	280
2-0012	400
2-0013	550
2-0014	700
2-4003	800

Código	KG
2-0015	280
2-0016	400
2-0017	550
2-0018	700
2-4004	800

Código	KG
2-1622	280
2-1623	400
2-1624	550
2-1637	700
2-4005	800

Código	KG
2-0063	280
2-0064	425
2-0065	550
2-0066	750
2-4002	900

Soporta temperaturas de hasta +200°C

Rueda TT

Resina alta temperatura

100 - 125 kg



VENTAJAS DEL ARO

- Facilidad de desplazamiento **+**
- Ruido durante la marcha **+**
- Protección del suelo **+**

-30° a +280°

Más información en página 289



*** AMPLIAMOS GAMA**



Cojinete
Eje

Cojinete	Eje	
80	34	---
100	34	---
100	34	●●

Código	KG
2-1056*	100
2-1058*	125
* 2-4983*	125

Código	KG
2-1057*	100
2-1059*	125
* 2-4984*	125

Código	KG
2-1625*	100
2-1626*	125
* 2-4985*	125

Código	KG
2-1052*	100
2-1053*	125
* 2-4521*	125

* Con cojinete opcional de teflón. Código 2-1114

Soporta temperaturas de hasta +280°C en intervalos de 30 min.

Rueda TA

Acero

300 - 800 kg



VENTAJAS DEL ARO

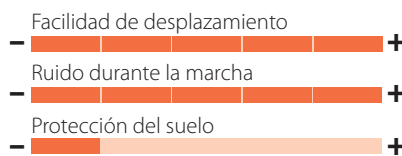

-90° a +600°

Más información en página 288

*** AMPLIAMOS GAMA**



Cojinete Eje

80	34	—
100	34	—
125	44	—
125	40	●●
150	45	—
150	45	●●
200	45	—
200	45	●●

Código	KG
2-0028	300
2-0029	400
2-0030	600
* 2-4978	600
2-0031	750
* 2-2894	750
2-0221	800
2-1574	800

Código	KG
2-0032	300
2-0033	400
2-0034	600
* 2-4979	600
2-0035	750
* 2-2895	750
2-0222	800
2-2897	800

Código	KG
2-1628	300
2-1629	400
2-1630	600
* 2-4980	600
2-1639	750
* 2-2896	750
2-0960	800
2-2898	800

Código	KG
2-0072	300
2-0073	450
2-0074	630
4-0558	630
4-0559	1.175
4-0560	1.175
4-0562	1.250
4-0563	1.250

Las versiones con cojinetes de bolas, deben trabajar en un rango de temperatura: -40° a +150°

Para temperaturas superiores a 200° reducir carga (kg) un 40%

www.me...

Accesorio protección **pie rígido**



Código

150	2-3622
160	2-3622
200	2-3655

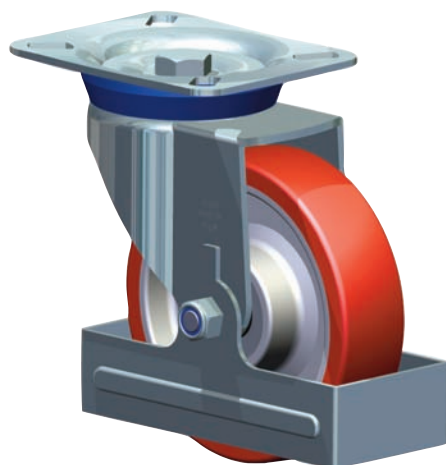

Para solicitar la protección pie, añadir a la rueda solicitada el código correspondiente.

**PROTECCIÓN
PIE**



Accesorio protección **pie flexible**



Código

150	2-4036
160	2-4036
200	2-4037



Para solicitar la protección pie, añadir a la rueda solicitada el código correspondiente.

**PROTECCIÓN
PIE**



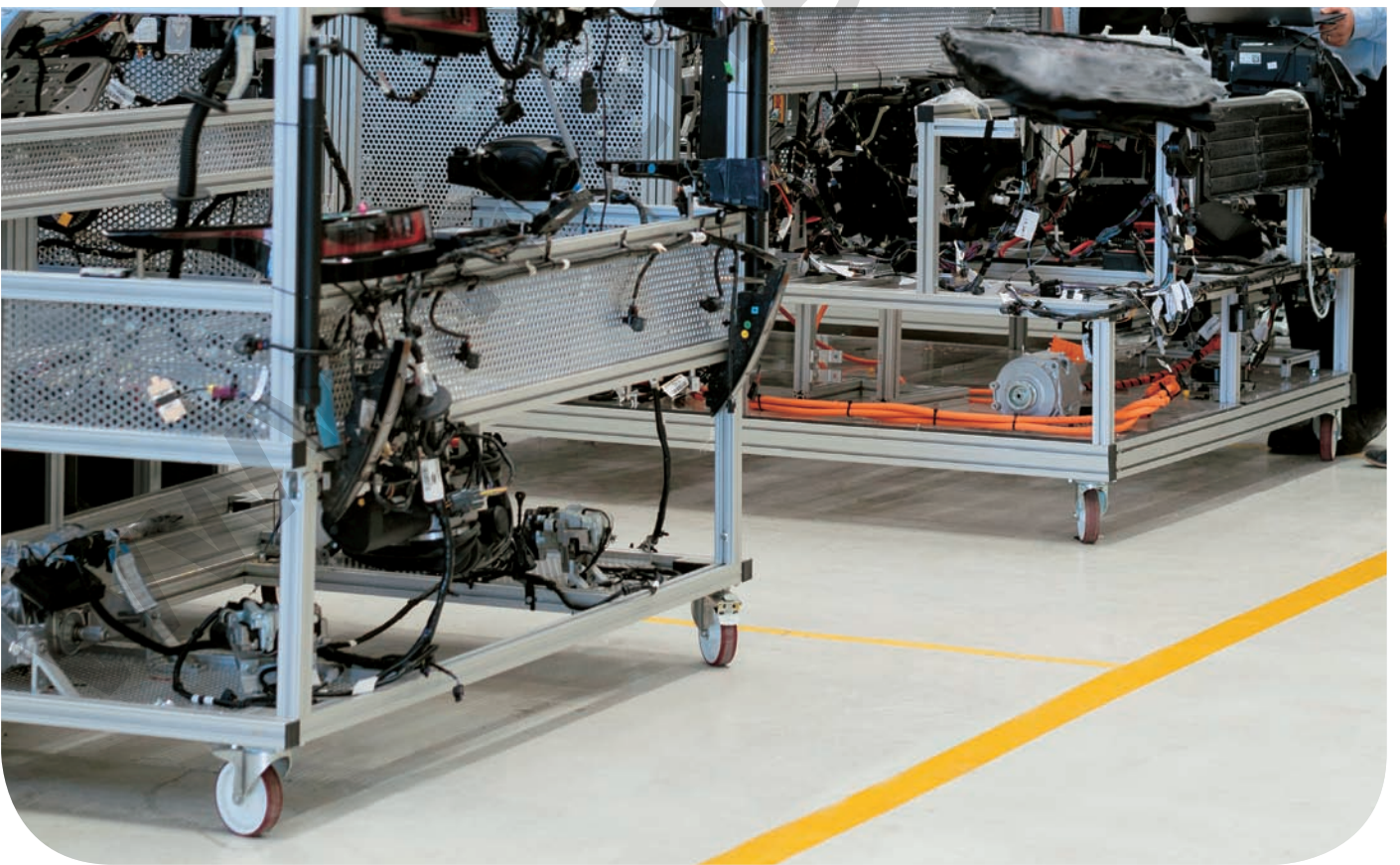

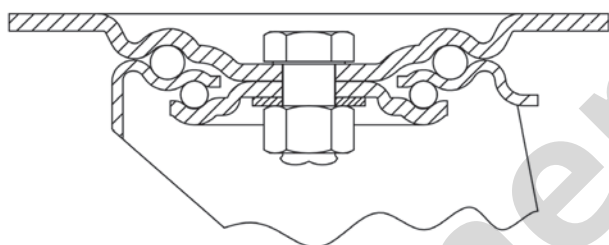
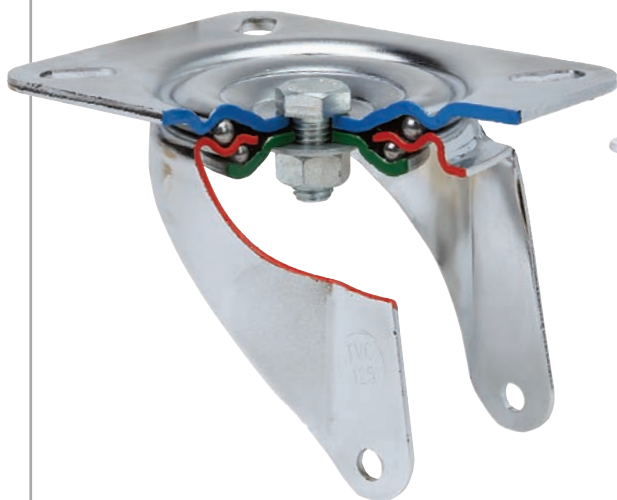

200 - 280 kg **125 mm**

- » Acabado cincado de alta resistencia al óxido
- » Fabricadas según normas europeas EN 12532

DETALLES DEL PRODUCTO

- ✓ Fabricada con chapa de acero de gran resistencia.
- ✓ Doble rodamiento a bolas.
- ✓ Protector anti-polvo en el cojinete del soporte.
- ✓ Modelo diseñado especialmente para: Contenedores y roll-palets de carga media.

Medidas Generales

125	139x110	136x116	105x80	10	-	154	110

* Detalle de planos de platina, ver página 24

Rueda DE

Goma elástica

250 kg



VENTAJAS DEL ARO

- Facilidad de desplazamiento
- Ruido durante la marcha
- Protección del suelo

-20° a +70°

Más información en página 274



125



40

Cojinete Eje



Código

2-3715



250

Código

2-3716



250

Código

2-3717



250

Código

4-0996



250

Rueda TPG

Goma negra natural

200 kg



VENTAJAS DEL ARO

- Facilidad de desplazamiento
- Ruido durante la marcha
- Protección del suelo

-20° a +60°

Más información en página 276



125



44

Cojinete Eje



Código

2-1005



200

Código

2-1014



200

Código

2-1015



200

Código

2-0061



200

125

44



2-3706

200

2-3707

200

2-3708

200

2-0785

200

Rueda PO

Poliuretano inyectado

280 kg



VENTAJAS DEL ARO

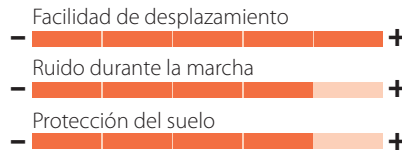

-25° a +60°

Más información en página 281



Cojinete
Eje

125	42	
125	42	

Código



2-3709	280
2-3712	280

Código



2-3710	280
2-3713	280

Código



2-3711	280
2-3714	280

Código



4-0480	300
4-0481	300

Rueda TP

Poliamix blanco

280 kg



VENTAJAS DEL ARO

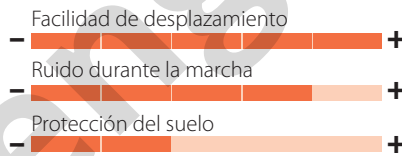

-20° a +60°

Más información en página 287



Cojinete
Eje

125	45	
125	45	

Código



2-2269	280
2-2450	280

Código



2-2284	280
2-2451	280

Código



2-2674	280
2-2893	280

Código



2-2478	300
2-0163	350



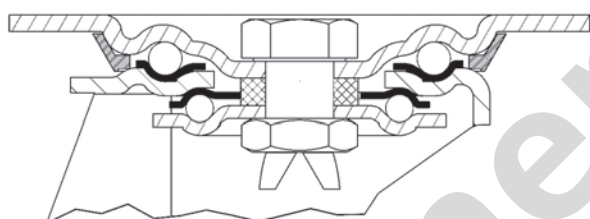

350 - 700 kg 150 a 200 mm

» Fabricadas según normas europeas EN 12532/12533

DETALLES DEL PRODUCTO

- ✓ Fabricada con chapa de acero embutido de hasta 4 mm de espesor.
- ✓ Doble rodamiento a bolas reforzado con pistas de rodadura endurecidas.
- ✓ Protector anti-polvo en el cojinete del soporte con engrasador.

Medidas Generales



Weight (kg)	Plate Size (GIRAT)	Plate Size (FIJA)	Wheel Diameter	Mounting Height	Wheel Diameter	Mounting Height
150	140x110	136x116	105x80	10	198	132
160	140x110	136x116	105x80	10	203	137
200	140x110	136x116	105x80	10	244	160

* Detalle de planos de platina, ver página 25

Rueda DEGB

Goma elástica gris

350 - 450 kg



VENTAJAS DEL ARO

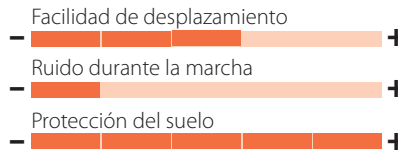

–20° a +70°

Más información en página 274

NOVEDAD



BLOQUEO DIRECCIONAL



Cojinete Eje

160	50	
200	50	

Código



2-4372	350
2-4376	450

Código



2-4373	350
2-4377	450

Código



2-4374	350
2-4378	450

Código



2-4375	350
2-4379	450

Rueda HU

Poliuretano fundido

650 - 700 kg



VENTAJAS DEL ARO

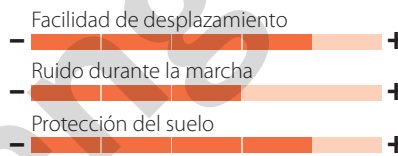

–20° a +60°

Más información en página 278



Cojinete Eje

150	50	
200	50	

Código



2-3865	650
2-3869	700

Código



2-3866	650
2-3870	700

Código



2-3867	650
2-3871	700

Código



2-3868	650
2-3872	700

BLOQUEO DIRECCIONAL



Rueda HUAB

Poliuretano fundido

600 - 700 kg



VENTAJAS DEL ARO

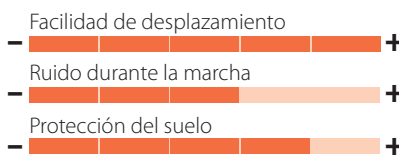

-20° a +60°

Más información en página 289

BLOQUEO DIRECCIONAL



Cojinete Eje

150	50	
200	50	

Código



2-3857	600
2-3861	700

Código



2-3858	600
2-3862	700

Código



2-3859	600
2-3863	700

Código



2-3860	600
2-3864	700

▲ Rueda con banda de rodadura en forma balona. **Menor esfuerzo al giro y desplazamiento.**

Rueda AUB

Poliuretano fundido

600 - 700 kg



VENTAJAS DEL ARO

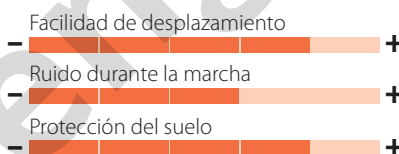

-20° a +60°

Más información en página 279

BLOQUEO DIRECCIONAL



Cojinete Eje

160	50	
200	50	

Código



2-3849	600
2-3853	700

Código



2-3850	600
2-3854	700

Código



2-3851	600
2-3855	700

Código



2-3852	600
2-3856	700

Rueda AUAB

Poliuretano fundido

550 - 700 kg



VENTAJAS DEL ARO

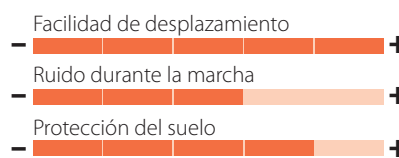

–20° a +60°

Más información en página 279

BLOQUEO DIRECCIONAL



Cojinete Eje

160	50	
200	50	

Código



2-3966	550
2-3979	700

Código



2-3967	550
2-3980	700

Código



2-3968	550
2-3981	700

Código



2-3969	550
2-3982	700

▲ Rueda con banda de rodadura en forma balona. **Menor esfuerzo al giro y desplazamiento.**

Rueda AUGB

Poliuretano verde fundido

550 - 700 kg



VENTAJAS DEL ARO

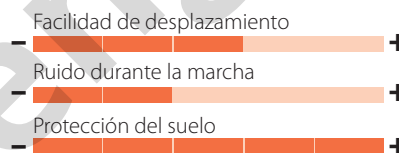

–20° a +60°

Más información en página 280

BLOQUEO DIRECCIONAL



Cojinete Eje

160	50	
200	50	

Código



2-3920	550
2-3845	700

Código



2-3921	550
2-3846	700

Código



2-3922	550
2-3847	700

Código



2-3923	550
2-3848	700

▲ Rueda de poliuretano verde. **Mayor elasticidad.**

Rueda AUAGB

Poliuretano verde fundido

500 - 650 kg



VENTAJAS DEL ARO

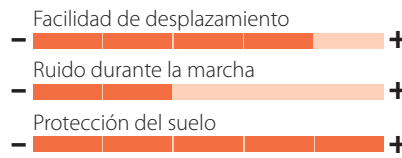

Temperatura: -20° a +60°

Más información en página 280

NOVEDAD

BLOQUEO DIRECCIONAL



Cojinete	Eje	Diagrama
160	50	
200	50	

Código	KG
2-4380	500
2-4384	650

Código	KG
2-4381	500
2-4385	650

Código	KG
2-4382	500
2-4386	650

Código	KG
2-4383	500
2-4387	650

▲ Rueda con banda de rodadura en forma balona. **Menor esfuerzo al giro y desplazamiento.**

Rueda AUSB

Poliuretano blanco fundido

500 - 650 kg



VENTAJAS DEL ARO

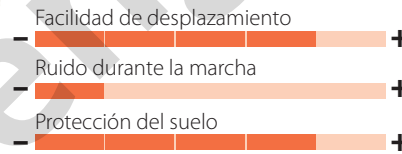

Temperatura: -20° a +60°

Más información en página 280

RUEDA DE VELOCIDAD

BLOQUEO DIRECCIONAL



Cojinete	Eje	Diagrama
160	50	
200	50	

Código	KG
2-4180	500
2-4187	650

Código	KG
2-4181	500
2-4188	650

Código	KG
2-4182	500
2-4189	650

Código	KG
2-4183	500
2-4190	650

▲ Ruedas **recomendadas** para desplazamientos **en velocidad (hasta 16 Km/h)**
 ▲ Cargas recomendadas según velocidad: 6 km/h -20%, 10 km/h -40%, 16 km/h -60%

Rueda FT

Poliamida reforzada

650 - 700 kg



VENTAJAS DEL ARO

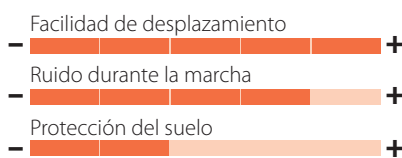

-30° a +80°

Más información en página 284

BLOQUEO DIRECCIONAL



Cojinete
Eje

150	45	
150	45	
200	50	
200	50	

Código	KG
2-3873	650
2-3881	650
2-3877	700
2-3885	700

Código	KG
2-3874	650
2-3882	650
2-3878	700
2-3886	700

Código	KG
2-3875	650
2-3883	650
2-3879	700
2-3887	700

Código	KG
2-3876	650
2-3884	650
2-3880	700
2-3888	700

Rueda TA

Hierro fundido

650 - 700 kg



VENTAJAS DEL ARO

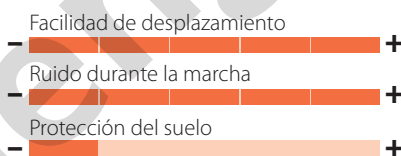

-90° a +600°

Más información en página 288

BLOQUEO DIRECCIONAL



Cojinete
Eje

150	45	
150	45	
200	45	
200	45	

Código	KG
2-3889	650
2-3897	650
2-3893	700
2-3901	700

Código	KG
2-3890	650
2-3898	650
2-3894	700
2-3902	700

Código	KG
2-3892	650
2-3900	650
2-3896	700
2-3904	700

Las versiones con cojinetes de bolas, deben trabajar en un rango de temperatura: -40° a +150°

Para temperaturas superiores a 200° reducir carga (kg) un 40%

Accesorio protección pie flexible



Código

150	2-4036
160	2-4036
200	2-4037



Para solicitar la protección pie, añadir a la rueda solicitada el código correspondiente.

PROTECCIÓN
PIE





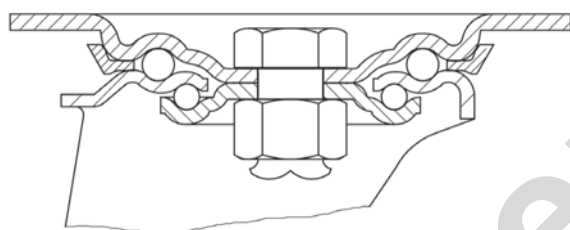

70 - 450 kg



80 a 250 mm

- » Acabado cincado brillante
- » Fabricadas según normas europeas EN 12530/12532

DETALLES DEL PRODUCTO

- ✓ Fabricada con chapa de acero hasta 4 m/m de espesor.
- ✓ Cabezal giratorio construido con doble hilera de bolas endurecidas
- ✓ Modelo de uso universal para cargas medias.
- ✓ Especialmente diseñado para transporte industrial.

Con bloqueo direccional disponible en diámetros 150 a 200 mm. Convierte una rueda giratoria en fija.

Medidas Generales

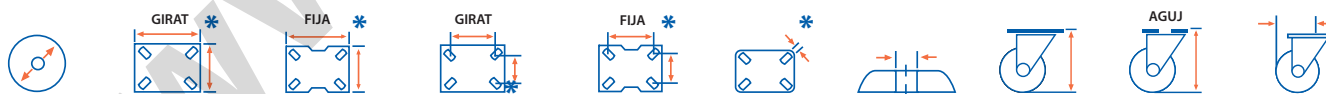

80	105x80	107x86	86/80x60	80x60	8	10/12	110	104	77
100L	105x80	107x86	86/80x60	80x60	8	10/12	131	124	91
100	106x86	107x86	86/80x60	80x60	8	12	133	128	95
125L	105x80	107x86	86/80x60	80x60	8	10/12	155	148	104
125	106x86	107x86	86/80x60	80x60	8	12	155	151	107
150L	106x86	107x86	86/80x60	80x60	8	12	182	177	115
150	140x110	136x116	105x80	105x80	10	12	196	190	128
160	140x110	136x116	105x80	105x80	10	12	201	195	133
200	140x110	136x116	105x80	105x80	10	12	242	236	155
250	140x110	146x107	105x80	105x80	12	-	291	-	193

* Detalle de planos de platina, ver página 25

Rueda DE

Goma elástica

200 - 450 kg



VENTAJAS DEL ARO

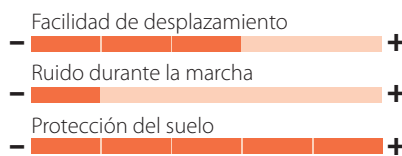

🌡️ -20° a +70°

Más información en página 274

BLOQUEO DIRECCIONAL



Cojinete Eje

100	40	
125	40	
160	50	
200	50	
250	50	

Código	KG
2-1190	200
2-2792	250
2-1192	350
2-1193	400
2-2678	450

Código	KG
2-1357	200
2-2793	250
2-1473	350
2-1313	400
2-2679	450

Código	KG
2-1155	200
2-2794	250
2-1157	350
2-1158	400
2-4684	450

Código	KG
-	-
-	-
2-3327	350
2-3328	400
-	-

150 - 300 kg



Cojinete Eje

100	12	40	
125	12	40	
160	12	50	
200	12	50	
250	12	50	

Código	KG
2-1359	150
2-2795	200
2-1361	300
2-1362	300
-	-

Código	KG
2-1363	150
2-2796	200
2-1365	300
2-1366	300
-	-

Código	KG
4-0995	200
4-1606	250
4-0997	350
4-0998	450
4-0999	500

Rueda DEGB

Goma elástica gris

350 - 400 kg



VENTAJAS DEL ARO

- Facilidad de desplazamiento - +
- Ruido durante la marcha - +
- Protección del suelo - +

-20° a +70°

Más información en página 274

NOVEDAD



BLOQUEO DIRECCIONAL



Cojinete Eje

160	50	
200	50	

Código



2-4360	350
2-4366	400

Código



2-4361	350
2-4367	400

Código



2-4362	350
2-4368	400

Código



2-4365	350
2-4371	400

300 kg

NOVEDAD

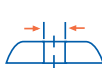

Cojinete Eje

160	12	50	
200	12	50	

Código



2-4363	300
2-4369	300

Código



2-4364	300
2-4370	300

Código



4-1659	350
4-1660	450

Rueda BS

Goma negra natural

80 - 250 kg



VENTAJAS DEL ARO

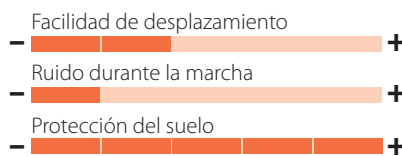

🌡️ -20° a +60°

Más información en página 271

*** AMPLIAMOS GAMA**



BLOQUEO DIRECCIONAL



Cojinete Eje

80	27	
100L	27	
100	27	
125L	35	
125	35	
160	37	
200	46	
250	50	

Código	KG
2-0223	80
2-1000	110
2-0225	110
* 2-4838	140
2-0227	140
2-0231	180
2-0233	230
2-0245	250

Código	KG
2-0224	80
2-1003	110
2-0226	110
* 2-4839	140
2-0228	140
2-0232	180
2-0234	230
2-0248	250

Código	KG
2-2309	80
2-1908	110
2-1149	110
* 2-4840	140
2-1150	140
2-0952	180
2-0955	230
2-4686	250

Código	KG
-	-
-	-
-	-
-	-
-	-
2-3333	180
2-3334	230
-	-

80 - 230 kg

*** AMPLIAMOS GAMA**

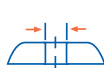

Cojinete Eje

80	10	27	
80	12	27	
100L	10	27	
100L	12	27	
100	12	27	
125L	12	35	
125	12	35	
160	12	37	
200	12	46	

Código	KG
2-1388	80
2-4066	80
2-1389	110
2-4086	110
2-1390	110
* 2-4841	140
2-1391	140
2-1394	180
2-1024	230

Código	KG
2-2311	80
2-4087	80
2-1910	110
2-4088	110
2-1374	110
* 2-4842	140
2-1396	140
2-1398	180
2-1401	230

Código	KG
2-0411	80
2-0411	80
2-0412	110
2-0412	110
2-0412	110
4-0743	140
4-0743	140
4-0744	180
4-0745	230

Rueda PS

Goma negra natural

70 - 215 kg



VENTAJAS DEL ARO

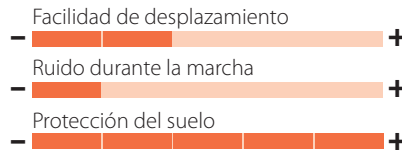

🌡️ -20° a +60°

Más información en página 276

*** AMPLIAMOS GAMA**



BLOQUEO DIRECCIONAL



Cojinete Eje

80	25	—
100L	28	—
100	28	—
125L	35	—
125	35	—
150L	35	—
160	40	—
160	40	—
200	47	—
200	47	—

Código	KG
2-0857	70
2-0999	100
2-0858	100
* 2-4843	125
2-0860	125
2-2885	150
2-0864	160
2-1071	160
2-0865	215
2-1073	215

Código	KG
2-0867	70
2-1002	100
2-0868	100
* 2-4844	125
2-0870	125
2-2886	150
2-0874	160
2-1072	160
2-0875	215
2-1074	215

Código	KG
2-2306	70
2-1905	100
2-1151	100
* 2-4845	125
2-1153	125
2-2887	150
2-0957	160
2-1115	160
2-0958	215
2-1075	215

Código	KG
-	-
-	-
-	-
-	-
-	-
-	-
2-3329	160
2-3330	160
2-3331	215
2-3332	215

70 - 215 kg

*** AMPLIAMOS GAMA**



Cojinete Eje

80	10	25	—
80	12	25	—
100L	10	28	—
100L	12	28	—
100	12	28	—
125L	12	35	—
125	12	35	—
150L	12	35	—
160	12	40	—
160	12	40	—
200	12	47	—
200	12	47	—

Código	KG
2-1338	70
2-4063	70
2-1339	100
2-4089	100
2-1341	100
* 2-4846	125
2-1343	125
2-2888	150
2-1346	160
2-1347	160
2-1027	215
2-1348	215

Código	KG
2-2307	70
2-4090	70
2-1906	100
2-4091	100
2-1349	100
* 2-4847	125
2-1351	125
2-2889	150
2-1353	160
2-1354	160
2-1355	215
2-1356	215

Código	KG
2-0848	75
2-0848	75
2-0849	100
2-0849	100
2-0849	100
2-0850	125
2-0850	125
2-0851	150
2-0852	160
2-1122	160
2-0853	215
2-1123	215

Rueda PS gris

Goma gris natural

160 - 215 kg



VENTAJAS DEL ARO

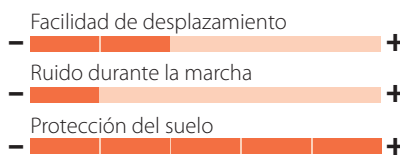

-20° a +60°

Más información en página 277



BLOQUEO DIRECCIONAL



Cojinete Eje

160	40	—
160	40	▨
160	40	●●
200	47	—
200	47	▨
200	47	●●

Código	KG
2-3399	160
2-3400	160
2-3550	160
2-3401	215
2-3402	215
2-3551	215

Código	KG
2-3403	160
2-3404	160
2-3552	160
2-1483	215
2-3405	215
2-3553	215

Código	KG
2-3406	160
2-3407	160
2-3554	160
2-1482	215
2-3408	215
2-3555	215

Código	KG
2-3427	160
2-3428	160
2-3556	160
2-3429	215
2-3430	215
2-3557	215

160 - 215 kg



Cojinete Eje

160	12	40	—
160	12	40	▨
160	12	40	●●
200	12	47	—
200	12	47	▨
200	12	47	●●

Código	KG
2-3409	160
2-3410	160
2-3558	160
2-3411	215
2-3412	215
2-3559	215

Código	KG
2-3413	160
2-3414	160
2-3560	160
2-3415	215
2-3416	215
2-3561	215

Código	KG
2-3397	160
2-3398	160
2-3548	160
2-3395	215
2-3396	215
2-3549	215

Rueda PGA

Goma gris natural

80 - 140 kg



VENTAJAS DEL ARO

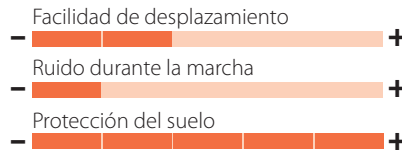

🌡️ -20° a +60°

Más información en página 272

*** AMPLIAMOS GAMA**



Cojinete Eje

80	32	—
80	32	●●*
100L	32	—
100L	32	●●*
100	32	—
100	32	●●*
125L	32	—
125L	32	●●*
125	32	—
125	32	●●*
150L	32	—
150L	32	●●*

Código	KG
2-2384	80
2-2385	80
2-2484	110
2-2485	110
2-2386	110
2-2387	110
2-4848	135
2-4853	135
2-2388	135
2-2389	135
2-4347	140
2-4352	140

Código	KG
2-2390	80
2-2391	80
2-2486	110
2-2501	110
2-2392	110
2-2393	110
2-4849	135
2-4854	135
2-2394	135
2-2395	135
2-4348	140
2-4353	140

Código	KG
2-2396	80
2-2397	80
2-2502	110
2-2503	110
2-2398	110
2-2399	110
2-4850	135
2-4855	135
2-2400	135
2-2401	135
2-4349	140
2-4354	140

Código	KG
2-1312	80
2-0807	80
2-0784	110
2-1124	110
2-0784	110
2-1124	110
2-0790	135
2-1125	135
2-0790	135
2-1125	135
2-1252	140
2-1253	140

* Versiones con cojinete de bolas en el eje, anti-hilos metálico incluido.

Rueda PGA

Goma gris natural

80 - 140 kg



VENTAJAS DEL ARO

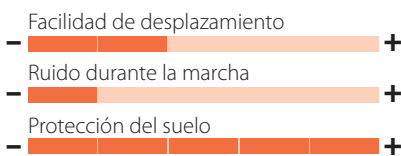

—20° a +60°

Más información en página 272

*** AMPLIAMOS GAMA**

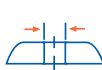

Cojinete Eje

80	10	32	—
80	12	32	—
80	10	32	●●*
80	12	32	●●*
100L	10	32	—
100L	12	32	—
100L	10	32	●●*
100L	12	32	●●*
100	12	32	—
100	12	32	●●*
125L	12	32	—
125L	12	32	●●*
125	12	32	—
125	12	32	●●*
150L	12	32	—
150L	12	32	●●*

Código



2-2402	80
2-4070	80
2-2403	80
2-4071	80
2-2504	110
2-4092	110
2-2505	110
2-4093	110
2-2404	110
2-2405	110
* 2-4851	135
* 2-4856	135
2-2406	135
2-2407	135
* 2-4350	140
* 2-4355	140

Código



2-2408	80
2-4094	80
2-2409	80
2-4095	80
2-2492	110
2-4096	110
2-2493	110
2-4097	110
2-2410	110
2-2411	110
* 2-4852	135
* 2-4857	135
2-2412	135
2-2413	135
* 2-4351	140
* 2-4356	140

Código



2-1312	80
2-1312	80
2-0807	80
2-0807	80
2-0784	110
2-0784	110
2-1124	110
2-1124	110
2-0784	110
2-1124	110
* 2-0790	135
* 2-1125	135
2-0790	135
2-1125	135
* 2-1252	140
* 2-1253	140

* Versiones con cojinete de bolas en el eje, anti-hilos metálico incluido.

Rueda PGM

Goma elástica azul

120 - 400 kg



VENTAJAS DEL ARO

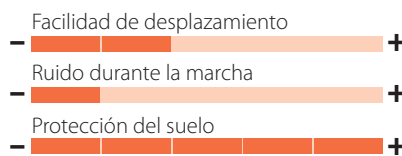

🌡️ -20° a +70°

Más información en página 271

*** AMPLIAMOS GAMA**



BLOQUEO DIRECCIONAL



Cojinete Eje

			Código	KG	Código	KG	Código	KG	Código	KG
80	34		2-3497	120	2-3498	120	2-3499	120	-	-
100L	36		2-2723	150	2-2729	150	2-2735	150	-	-
100L	36		* 2-4445	150	* 2-4446	150	* 2-4447	150	-	-
100	36		2-2725	170	2-2731	170	2-2737	170	-	-
100	36		* 2-4452	170	* 2-4453	170	* 2-4454	170	-	-
125L	36		* 2-4858	200	* 2-4859	200	* 2-4860	200	-	-
125L	36		* 2-4973	200	* 2-4974	200	* 2-4975	200	-	-
125	36		2-2726	225	2-2732	225	2-2738	225	-	-
125	36		* 2-4457	225	* 2-4458	225	* 2-4459	225	-	-
150L	36		* 2-4260	250	* 2-4261	250	* 2-4262	250	-	-
160	45		2-2727	300	2-2733	300	2-2739	300	2-3336	300
160	45		* 2-4462	300	* 2-4463	300	* 2-4464	300	* 2-4465	300
200	45		2-2728	400	2-2734	400	2-2740	400	2-3337	400
200	45		* 2-4468	400	* 2-4469	400	* 2-4470	400	* 2-4471	400

Rueda PGR

Goma elástica gris

120- 400 kg



VENTAJAS DEL ARO

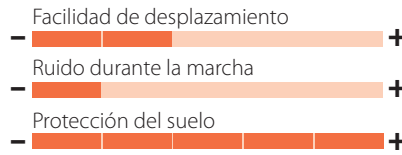

🌡️ -20° a +70°

Más información en página 272

*** AMPLIAMOS GAMA**



BLOQUEO DIRECCIONAL



Cojinete Eje

80	34	
100L	36	
100	36	
125L	36	
125	36	
160	45	
200	45	

Código	KG
2-3751	120
2-3756	150
2-3757	170
* 2-4863	200
2-3766	225
2-3771	300
2-3777	400

Código	KG
2-3752	120
2-3758	150
2-3759	170
* 2-4864	200
2-3767	225
2-3772	300
2-3778	400

Código	KG
2-3753	120
2-3760	150
2-3761	170
* 2-4865	200
2-3768	225
2-3773	300
2-3779	400

Código	KG
-	-
-	-
-	-
-	-
-	-
2-3776	300
2-3782	400

Rueda PGR

Goma elástica gris

100- 280 kg



VENTAJAS DEL ARO

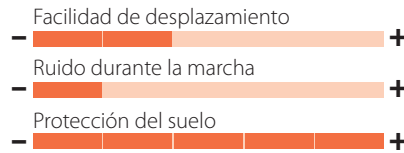

🌡️ -20° a +70°

Más información en página 272

* **AMPLIAMOS GAMA**

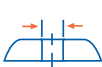
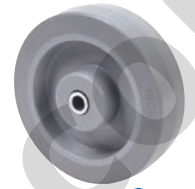

Cojinete Eje

80	10	34	📏
80	12	34	📏
100L	10	36	📏
100L	12	36	📏
100	12	36	📏
125L	12	36	📏
125	12	36	📏
160	12	45	📏
200	12	45	📏

Código



2-3754	100
2-4067	100
2-3762	130
2-4101	130
2-3763	150
* 2-4866	180
2-3769	200
2-3774	250
2-3780	280

Código



2-3755	100
2-4102	100
2-3764	130
2-4103	130
2-3765	150
* 2-4867	180
2-3770	200
2-3775	250
2-3781	280

Código



2-3746	120
2-3746	120
2-3747	170
2-3747	170
2-3747	170
2-3748	225
2-3748	225
2-3749	350
2-3750	400

Rueda PGZ

Goma gris inyectada

80 - 180 kg



VENTAJAS DEL ARO

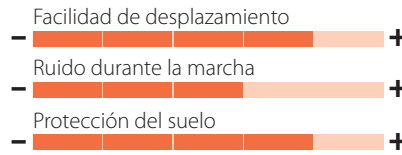

🌡️ -20° a +60°

Más información en página 275

*** AMPLIAMOS GAMA**



BLOQUEO DIRECCIONAL



Cojinete Eje

80	28	—
80	28	▨
100L	30	—
100L	30	▨
100	30	—
100	30	▨
125L	32	—
125L	32	▨
125	32	—
125	32	▨
160	38	—
200	45	—

Código	KG
2-3210	80
2-3211	80
2-3212	100
2-3213	100
2-3214	100
2-3215	100
2-4868	120
2-4873	120
2-3216	120
2-3217	120
2-3218	160
2-3219	180

Código	KG
2-3220	80
2-3221	80
2-3222	100
2-3223	100
2-3224	100
2-3225	100
2-4869	120
2-4874	120
2-3226	120
2-3227	120
2-3228	160
2-3229	180

Código	KG
2-3230	80
2-3231	80
2-3232	100
2-3233	100
2-3234	100
2-3235	100
2-4870	120
2-4875	120
2-3236	120
2-3237	120
2-3238	160
2-3239	180

Código	KG
-	-
-	-
-	-
-	-
-	-
-	-
-	-
-	-
-	-
-	-
2-3435	160
2-3436	180

Rueda PGZ

Goma gris inyectada

80 - 180 kg



VENTAJAS DEL ARO

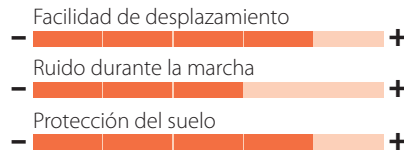

-20° a +60°

Más información en página 275

*** AMPLIAMOS GAMA**



			Cojinete Eje
80	10	28	—
80	12	28	—
80	10	28	▨
80	12	28	▨
100L	10	30	—
100L	12	30	—
100L	10	30	▨
100L	12	30	▨
100	12	30	—
100	12	30	▨
125L	12	32	—
125L	12	32	▨
125	12	32	—
125	12	32	▨
160	12	38	—
200	12	45	—

Código	KG
2-3240	80
2-4076	80
* 2-3241	80
* 2-4569	80
2-3242	100
2-4104	100
* 2-3243	100
* 2-4573	100
2-3244	100
* 2-3245	100
* 2-4871	120
* 2-4876	120
2-3246	120
* 2-3247	120
2-3248	160
2-3249	180

Código	KG
2-3250	80
2-4105	80
* 2-3251	80
* 2-4570	80
2-3252	100
2-4106	100
* 2-3253	100
* 2-4574	100
2-3254	100
* 2-3255	100
* 2-4872	120
* 2-4877	120
2-3256	120
* 2-3257	120
2-3258	160
2-3259	180

Código	KG
2-3142	80
2-3142	80
2-3147	80
2-3147	80
2-3143	100
2-3143	100
2-3148	100
2-3148	100
2-3143	100
2-3148	100
2-3144	120
2-3149	120
2-3144	120
2-3149	120
2-3145	160
2-3146	180

Rueda PGAIB

Goma gris inyectada

100 - 125 kg



VENTAJAS DEL ARO

- Facilidad de desplazamiento
- Ruido durante la marcha
- Protección del suelo

-20° a +60°

Más información en página 273

NOVEDAD



Cojinete Eje

100L	100	125L	125	150L
32	32	32	32	32

Código	KG
2-4774	100
2-4777	100
2-4828	125
2-4780	125
2-4783	125

Código	KG
2-4775	100
2-4778	100
2-4829	125
2-4781	125
2-4784	125

Código	KG
2-4776	100
2-4779	100
2-4830	125
2-4782	125
2-4785	125

Código	KG
2-2759	100
2-2759	100
2-1146	125
2-1146	125
2-3577	125

100 - 125 kg

NOVEDAD

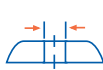

Cojinete Eje

100L	100L	100	125L	125	150L
10	12	12	12	12	12
32	32	32	32	32	32

Código	KG
2-4786	100
2-4788	100
2-4790	100
2-4831	125
2-4792	125
2-4794	125

Código	KG
2-4787	100
2-4789	100
2-4791	100
2-4832	125
2-4793	125
2-4795	125

Código	KG
2-2759	100
2-2759	100
2-2759	100
2-1146	125
2-1146	125
2-3577	125

Rueda AUB

Poliuretano fundido

130 - 400 kg



VENTAJAS DEL ARO

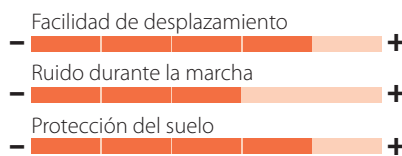

-20° a +60°

Más información en página 279

*** AMPLIAMOS GAMA**



BLOQUEO DIRECCIONAL



Cojinete Eje

80	38	
100	38	
125	38	
160	50	
200	50	
250	60	

Código	KG
* 2-4652	130
2-2526	200
2-2527	250
2-2528	350
2-2529	400
2-2680	400

Código	KG
* 2-4653	130
2-2530	200
2-2531	250
2-2532	350
2-2533	400
2-2681	400

Código	KG
* 2-4654	130
2-2534	200
2-2535	250
2-2536	350
2-2537	400
2-4685	400

Código	KG
-	-
-	-
-	-
2-3338	350
2-3339	400
-	-

130 - 300 kg

*** AMPLIAMOS GAMA**

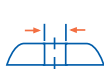

Cojinete Eje

80	10	38	
80	12	38	
100	12	38	
125	12	38	
160	12	50	
200	12	50	
250	12	60	

Código	KG
* 2-4655	130
* 2-4657	130
2-2538	150
2-2539	200
2-2540	250
2-2541	300
-	-

Código	KG
* 2-4656	130
* 2-4658	130
2-2542	150
2-2543	200
2-2544	250
2-2545	300
-	-

Código	KG
* 2-4651	150
* 2-4651	150
2-2546	200
2-2547	250
2-2548	600
2-2549	800
2-2550	1.000

Rueda AUAB

Poliuretano fundido

225 - 400 kg



VENTAJAS DEL ARO

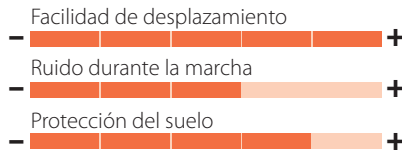

–20° a +60°

Más información en página 279

*** AMPLIAMOS GAMA**



BLOQUEO DIRECCIONAL

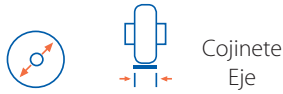

Cojinete Eje

125	40	
160	50	
200	50	

Código	KG
* 2-4813	225
2-3970	350
2-3983	400

Código	KG
* 2-4814	225
2-3971	350
2-3984	400

Código	KG
* 2-4815	225
2-3972	350
2-3985	400

Código	KG
-	-
2-3973	350
2-3986	400

250 - 300 kg

*** AMPLIAMOS GAMA**

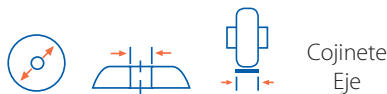

Cojinete Eje

125	12	40	
160	12	50	
200	12	50	

Código	KG
* 2-4816	200
2-3974	250
2-3987	300

Código	KG
* 2-4817	200
2-3975	250
2-3988	300

Código	KG
* 2-4812	225
2-3992	550
2-3993	700

▲ Rueda con banda de rodadura en forma balona. **Menor esfuerzo al giro y desplazamiento.**

Rueda AUGB

Poliuretano verde fundido

400 kg



VENTAJAS DEL ARO

- Facilidad de desplazamiento +
- Ruido durante la marcha +
- Protección del suelo +

-20° a +60°

Más información en página 280

BLOQUEO DIRECCIONAL



Cojinete Eje

160	50	
200	50	

Código



2-3924	400
2-3692	400

Código



2-3925	400
2-3693	400

Código



2-3926	400
2-3694	400

Código



2-3927	400
2-3695	400

300 kg

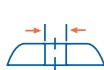

Cojinete Eje

160	12	50	
200	12	50	

Código



2-3928	300
2-3696	300

Código



2-3929	300
2-3697	300

Código



4-1654	550
4-1641	700

▲ Rueda de poliuretano verde. **Mayor elasticidad.**

Rueda AUAGB

Poliuretano verde fundido

350 - 400 kg



VENTAJAS DEL ARO

- Facilidad de desplazamiento - +
- Ruido durante la marcha - +
- Protección del suelo - +

Temperatura: -20° a +60°

Más información en página 280

NOVEDAD



BLOQUEO DIRECCIONAL



Cojinete Eje

160	50	
200	50	

Código



2-4388	350
2-4394	400

Código



2-4389	350
2-4395	400

Código



2-4390	350
2-4396	400

Código



2-4391	350
2-4397	400

250 - 300 kg

NOVEDAD



Cojinete Eje

160	12	50	
200	12	50	

Código



2-4392	250
2-4398	300

Código



2-4393	250
2-4399	300

Código



4-1661	500
4-1662	650

▲ Rueda con banda de rodadura en forma balona. **Menor esfuerzo al giro y desplazamiento.**

Rueda PO

Poliuretano inyectado

200 - 400 kg



VENTAJAS DEL ARO

- Facilidad de desplazamiento +
- Ruido durante la marcha +
- Protección del suelo +

🌡️ -25° a +80°

Más información en página 281

BLOQUEO DIRECCIONAL



Cojinete Eje

100	33	—
100	33	●●
150	42	—
150	42	●●
200	50	—
200	50	●●

Código	KG
2-2314	200
2-2315	200
2-2004	350
2-2005	350
2-2006	400
2-2007	400

Código	KG
2-2318	200
2-2319	200
2-2011	350
2-2012	350
2-2013	400
2-2014	400

Código	KG
2-2322	200
2-2323	200
2-2018	350
2-2019	350
2-2020	400
2-2021	400

Código	KG
-	-
-	-
2-3783	350
2-3784	350
2-3785	400
2-3786	400

180 - 300 kg

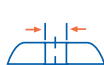

Cojinete Eje

100	12	33	—
100	12	33	●●
150	12	42	—
150	12	42	●●
200	12	50	—
200	12	50	●●

Código	KG
2-2326	180
2-2327	180
2-2025	250
2-2026	250
2-2027	300
2-2028	300

Código	KG
2-2330	180
2-2331	180
2-2032	250
2-2033	250
2-2034	300
2-2035	300

Código	KG
2-1443	200
4-0479	200
4-0482	450
4-0484	450
4-0486	600
4-0488	600

Rueda POL

Poliuretano inyectado

100 - 300 kg



VENTAJAS DEL ARO

- Facilidad de desplazamiento +
- Ruido durante la marcha +
- Protección del suelo +

🌡️ -25° a +80°

Más información en página 281

*** AMPLIAMOS GAMA**



BLOQUEO DIRECCIONAL

Dureza 60° shore D



Cojinete Eje

		Código		Código		Código		Código	
80	32	2-2354	100	2-2360	100	2-2366	100	-	-
80	32	2-2899	100	2-2902	100	2-2905	100	-	-
80	32	2-4201	100	2-4202	100	2-4203	100	-	-
100L	32	2-2355	130	2-2361	130	2-2367	130	-	-
100L	32	2-2965	130	2-2966	130	2-2967	130	-	-
100L	32	2-4206	130	2-4208	130	2-4210	130	-	-
100	32	2-2356	150	2-2362	150	2-2368	150	-	-
100	32	2-2900	150	2-2903	150	2-2906	150	-	-
100	32	2-4207	150	2-4209	150	2-4211	150	-	-
125L	32	* 2-4883	180	* 2-4884	180	* 2-4885	180	-	-
125L	32	* 2-4888	180	* 2-4889	180	* 2-4890	180	-	-
125L	32	* 2-4893	180	* 2-4894	180	* 2-4895	180	-	-
125	32	2-2357	200	2-2363	200	2-2369	200	-	-
125	32	2-2901	200	2-2904	200	2-2907	200	-	-
125	32	2-4216	200	2-4217	200	2-4218	200	-	-
150	42	2-2358	250	2-2364	250	2-2370	250	2-3340	250
150	42	2-3449	250	2-3451	250	2-3453	250	2-3489	250
200	50	2-2359	300	2-2365	300	2-2371	300	2-3341	300
200	50	2-3450	300	2-3452	300	2-3454	300	2-3490	300

Rueda POL

Poliuretano inyectado

100 - 300 kg



VENTAJAS DEL ARO

Facilidad de desplazamiento	+
Ruido durante la marcha	+
Protección del suelo	+

🌡️ -25° a +80°

Más información en página 281



Dureza 60° shore D

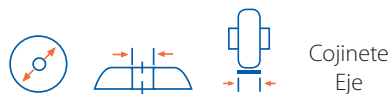

Cojinete Eje

80	10	32	Cojinete Eje
80	12	32	---
80	10	32	
80	12	32	
80	10	32	●●
80	12	32	●●
100L	10	32	---
100L	12	32	---
100L	10	32	
100L	12	32	
100L	10	32	●●
100L	12	32	●●
100	12	32	---
100	12	32	
100	12	32	●●
125L	12	32	---
125L	12	32	
125L	12	32	●●
125	12	32	---
125	12	32	
125	12	32	●●
150	12	42	---
150	12	42	
200	12	50	---
200	12	50	

Código	KG
2-2372	100
2-4069	100
2-2908	100
2-4074	100
2-4204	100
2-4241	100
2-2373	130
2-4113	130
2-2968	130
2-4114	130
2-4212	130
2-4243	130
2-2374	150
2-2909	150
2-4213	150
* 2-4886	180
* 2-4891	180
* 2-4896	180
2-2375	200
2-2910	200
2-4219	200
2-2376	250
2-3455	250
2-2377	300
2-3456	300

Código	KG
2-2378	100
2-4115	100
2-2911	100
2-4116	100
2-4205	100
2-4242	100
2-2379	130
2-4117	130
2-2969	130
2-4118	130
2-4214	130
2-4244	130
2-2380	150
2-2912	150
2-4215	150
* 2-4887	180
* 2-4892	180
* 2-4897	180
2-2381	200
2-2913	200
2-4220	200
2-2382	250
2-3457	250
2-2383	300
2-3458	300

Código	KG
2-2500	100
2-2500	100
2-2959	100
2-2959	100
2-4195	100
2-4195	100
2-2480	150
2-2480	150
2-2960	150
2-2960	150
2-4196	150
2-4196	150
2-2480	150
2-2960	150
2-4196	150
2-4196	150
2-2481	200
2-2961	200
2-4197	200
2-2481	200
2-2961	200
2-4197	200
2-2482	250
2-3441	250
2-2483	300
2-3442	300

Rueda POA

Poliuretano inyectado blando

100 - 250 kg



VENTAJAS DEL ARO

- Facilidad de desplazamiento - +
- Ruido durante la marcha - +
- Protección del suelo - +

🌡️ -25° a +80°

Más información en página 282

*** AMPLIAMOS GAMA**

Dureza 80° shore A

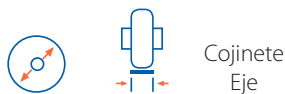

Código		KG	Código		KG	Código		KG	Código		KG
80	32	—	2-2820	100	2-2822	100	2-2821	100	-	-	
80	32	▬▬▬	2-2914	100	2-2917	100	2-2920	100	-	-	
80	32	●●	2-4221	100	2-4222	100	2-4223	100	-	-	
100L	32	▬▬▬	2-2825	130	2-2827	130	2-2826	130	-	-	
100L	32	▬▬▬	2-2970	130	2-2971	130	2-2972	130	-	-	
100L	32	●●	2-4226	130	2-4228	130	2-4230	130	-	-	
100	32	▬▬▬	2-2830	150	2-2832	150	2-2831	150	-	-	
100	32	▬▬▬	2-2915	150	2-2918	150	2-2921	150	-	-	
100	32	●●	2-4227	150	2-4229	150	2-4231	150	-	-	
125L	32	▬▬▬	* 2-4898	175	* 2-4899	175	* 2-4900	175	-	-	
125L	32	▬▬▬	* 2-4903	175	* 2-4904	175	* 2-4905	175	-	-	
125L	32	●●	* 2-4908	175	* 2-4909	175	* 2-4910	175	-	-	
125	32	▬▬▬	2-2835	175	2-2837	175	2-2836	175	-	-	
125	32	▬▬▬	2-2916	175	2-2919	175	2-2922	175	-	-	
125	32	●●	2-4236	175	2-4237	175	2-4238	175	-	-	
150	42	▬▬▬	2-2840	200	2-2842	200	2-2841	200	2-3342	200	
150	42	▬▬▬	2-3459	200	2-3461	200	2-3463	200	2-3491	200	
200	50	▬▬▬	2-2845	250	2-2847	250	2-2846	250	2-3343	250	
200	50	▬▬▬	2-3460	250	2-3462	250	2-3464	250	2-3492	250	

▲ Rueda de poliuretano azul. **Desplazamiento más silencioso y absorción de vibraciones.**

Rueda POA

Poliuretano inyectado blando

100 - 250 kg



VENTAJAS DEL ARO

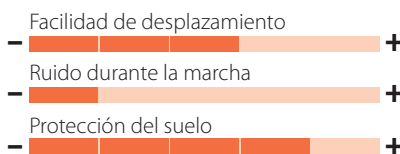

🌡️ -25° a +80°

Más información en página 282

*** AMPLIAMOS GAMA**

Dureza 80° shore A

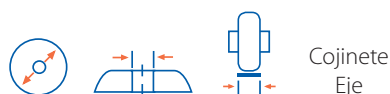

Cojinete Eje

80	10	32	Cojinete Eje
80	12	32	—
80	10	32	▨
80	12	32	▨
80	10	32	●●
80	12	32	●●
100L	10	32	—
100L	12	32	—
100L	10	32	▨
100L	12	32	▨
100L	10	32	●●
100L	12	32	●●
100	12	32	—
100	12	32	▨
100	12	32	●●
125L	12	32	▨
125L	12	32	▨
125L	12	32	●●
125	12	32	—
125	12	32	▨
125	12	32	●●
150	12	42	—
150	12	42	▨
200	12	50	—
200	12	50	▨

Código	KG
2-2823	100
2-4073	100
2-2923	100
2-4075	100
2-4224	100
2-4245	100
2-2828	130
2-4119	130
2-2973	130
2-4120	130
2-4232	130
2-4247	130
2-2833	150
2-2924	150
2-4233	150
* 2-4901	175
* 2-4906	175
* 2-4911	175
2-2838	175
2-2925	175
2-4239	175
2-2843	200
2-3465	200
2-2848	250
2-3466	250

Código	KG
2-2824	100
2-4121	100
2-2926	100
2-4122	100
2-4225	100
2-4246	100
2-2829	130
2-4123	130
2-2974	130
2-4124	130
2-4234	130
2-4248	130
2-2834	150
2-2927	150
2-4235	150
* 2-4902	175
* 2-4907	175
* 2-4912	175
2-2839	175
2-2928	175
2-4240	175
2-2844	200
2-3467	200
2-2849	250
2-3468	250

Código	KG
2-2850	100
2-2850	100
2-2962	100
2-2962	100
2-4198	100
2-4198	100
2-2851	150
2-2851	150
2-2963	150
2-2963	150
2-4199	150
2-4199	150
2-2851	150
2-2963	150
2-4199	150
2-2852	175
2-2964	175
2-4200	175
2-2852	175
2-2964	175
2-4200	175
2-2853	200
2-3443	200
2-2854	250
2-3444	250

▲ Rueda de poliuretano azul. **Desplazamiento más silencioso y absorción de vibraciones.**

Rueda PU

Poliuretano inyectado

150 - 200 kg



VENTAJAS DEL ARO

- Facilidad de desplazamiento
- Ruido durante la marcha
- Protección del suelo

-25° a +80°

Más información en página 283

*** AMPLIAMOS GAMA**

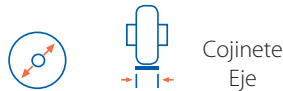

		Cojinete Eje
100L	32	
100	32	
125L	32	
125	32	
150L	32	

Código	KG
2-2001	150
2-2002	175
* 2-4878	180
2-2003	200
2-4270	200

Código	KG
2-2008	150
2-2009	175
* 2-4879	180
2-2010	200
2-4271	200

Código	KG
2-2015	150
2-2016	175
* 2-4880	180
2-2017	200
2-4272	200

Código	KG
2-1100	175
2-1100	175
2-1037	200
2-1037	200
2-3583	200

120 - 175 kg

*** AMPLIAMOS GAMA**

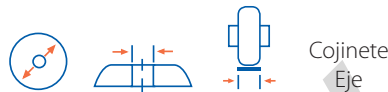

		Cojinete Eje
100L	10	32
100L	12	32
100	12	32
125L	12	32
125	12	32
150L	12	32

Código	KG
2-2022	120
2-4107	120
2-2023	130
* 2-4881	175
2-2024	175
2-4273	175

Código	KG
2-2029	120
2-4108	120
2-2030	130
* 2-4882	175
2-2031	175
2-4274	175

Código	KG
2-1100	175
2-1100	175
2-1100	175
2-1037	200
2-1037	200
2-3583	200

Rueda PGC

Poliuretano gris conductivo

100 - 200 kg



VENTAJAS DEL ARO

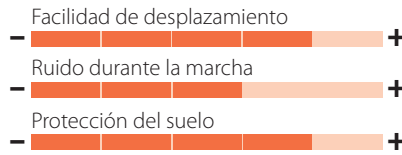

-25° a +80°

Más información en página 283



NOVEDAD



Cojinete Eje

80	32	
100L	32	
100	32	
125L	32	
125	32	
150L	32	

Código	KG
2-4698	100
2-4705	150
2-4712	175
2-4833	180
2-4717	200
2-4722	200

Código	KG
2-4699	100
2-4706	150
2-4713	175
2-4834	180
2-4718	200
2-4723	200

Código	KG
2-4700	100
2-4707	150
2-4714	175
2-4835	180
2-4719	200
2-4724	200

100 - 175 kg

NOVEDAD

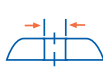

Cojinete Eje

80	10	32	
80	12	32	
100L	10	32	
100L	12	32	
100	12	32	
125L	12	32	
125	12	32	
150L	12	32	

Código	KG
2-4701	100
2-4703	100
2-4708	120
2-4710	120
2-4715	130
2-4836	175
2-4720	175
2-4725	175

Código	KG
2-4702	100
2-4704	100
2-4709	120
2-4711	120
2-4716	130
2-4837	175
2-4721	175
2-4726	175

Código	KG
2-1602	100
2-1602	100
2-1603	175
2-1603	175
2-1603	175
2-1604	200
2-1604	200
2-1605	200

Rueda UT

Poliamix blanco

130 - 400 kg



VENTAJAS DEL ARO

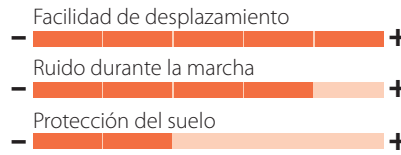

🌡️ -20° a +60°

Más información en página 286

*** AMPLIAMOS GAMA**



Cojinete Eje

80	34	—
80	34	▬▬▬
100L	34	—
100L	34	▬▬▬
100	34	—
100	34	▬▬▬
125L	35	—
125L	35	▬▬▬
125	35	—
125	35	▬▬▬
150L	38	—
150L	38	▬▬▬
150	45	—
200	50	—

Código	KG
2-0235	130
2-2332	130
2-1001	150
2-2333	150
2-0237	200
2-2334	200
* 2-4913	220
* 2-4918	220
2-0239	250
2-2235	250
2-4265	250
* 2-4564	250
2-0241	350
2-0243	400

Código	KG
2-0236	130
2-2336	130
2-1004	150
2-2337	150
2-0238	200
2-2338	200
* 2-4914	220
* 2-4919	220
2-0240	250
2-2236	250
2-4266	250
* 2-4565	250
2-0242	350
2-0244	400

Código	KG
2-2340	130
2-2341	130
2-1901	150
2-2342	150
2-1194	200
2-2343	200
* 2-4915	220
* 2-4920	220
2-1195	250
2-2237	250
2-4267	250
* 2-4566	250
2-0949	350
2-0950	400

Código	KG
-	-
-	-
-	-
-	-
-	-
-	-
-	-
-	-
-	-
-	-
-	-
-	-
-	-
-	-
2-3344	350
2-3345	400

www.alex.es

Rueda UT

Poliamix blanco

130 - 300 kg



VENTAJAS DEL ARO

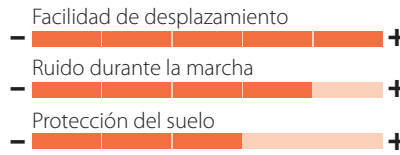

🌡️ -20° a +60°

Más información en página 286



80	10	34	Cojinete Eje
80	12	34	—
80	10	34	▨
80	12	34	▨
100L	10	34	—
100L	12	34	—
100L	10	34	▨
100L	12	34	▨
100	12	34	—
100	12	34	▨
125L	12	35	—
125L	12	35	▨
125	12	35	—
125	12	35	▨
150L	12	38	—
150L	12	38	▨
150	12	45	—
200	12	50	—

Código	KG
2-1368	130
2-4077	130
2-2345	130
2-4068	130
2-1369	150
2-4125	150
2-2346	150
2-4126	150
2-1370	180
2-2347	180
* 2-4916	200
* 2-4921	200
2-1371	220
2-2238	220
2-4268	200
* 2-4567	200
2-1373	250
2-1026	300

Código	KG
2-2349	130
2-4127	130
2-2350	130
2-4128	130
2-1903	150
2-4129	150
2-2351	150
2-4130	150
2-1375	180
2-2352	180
* 2-4917	200
* 2-4922	200
2-1376	220
2-2239	220
2-4269	200
* 2-4568	200
2-1377	250
2-1378	300

Código	KG
4-0023	200
2-2476	200
2-2476	200
4-0024	220
4-0024	220
2-2455	220
2-2455	220
4-0024	220
2-2455	220
4-0025	250
2-2240	250
4-0025	250
2-2240	250
2-1104	420
2-4563	420
2-0434	420
4-0027	500

Rueda TD

Resina extrafuerte

130 - 400 kg



VENTAJAS DEL ARO

- Facilidad de desplazamiento
- Ruido durante la marcha
- Protección del suelo

-40° a +200°

Más información en página 288



Soporta temperaturas de hasta +200°C



BLOQUEO DIRECCIONAL

				Código	KG	Código	KG	Código	KG	Código	KG	
			Cojinete Eje	80	10	28	2-1088	130	2-1089	130	2-1380	130
				80	12	28	-	-	-	2-4064	130	-
				100L	10	32	2-1090	150	2-1091	150	2-1381	150
				100L	12	32	-	-	-	2-4131	150	-
				100	12	32	2-1092	200	2-1093	200	2-1382	180
				150	12	42	2-1664	400	2-1688	400	2-1689	300
				200	12	50	2-4006	400	2-4007	400	2-4008	300
											2-3346	400
											2-4009	400

Rueda TT

Resina alta temperatura

100 - 125 kg



VENTAJAS DEL ARO

- Facilidad de desplazamiento
- Ruido durante la marcha
- Protección del suelo

-30° a +280°

Más información en página 289



Soporta temperaturas de hasta +280°C en intervalos de 30 min.



				Código	KG	Código	KG	Código	KG	Código	KG	
			Cojinete Eje	80	10	34	2-1094*	100	2-1095*	100	2-1383*	100
				80	12	34	-	-	-	2-4065*	100	2-1052*
				100L	10	34	2-1096*	125	2-1097*	125	2-1384*	125
				100L	12	34	-	-	-	2-4132*	125	2-1053*
				100L	10	34	2-4522	125	2-4523	125	2-4524	125
				100L	12	34	-	-	-	2-4525	125	2-4521
				100	12	34	2-1098*	125	2-1099*	125	2-1385*	125
				100	12	34	2-4526	125	2-4527	125	2-4528	125

* Con cojinete opcional de teflón. Código 2-1114

Rueda THG

Goma negra

100 kg



VENTAJAS DEL ARO

- Facilidad de desplazamiento +
- Ruido durante la marcha +
- Protección del suelo +

-30° a +250°

Más información en página 289



NOVEDAD



			Cojinete Eje	Código	KG	Código	KG	Código	KG	Código	KG
100L	10	38	====	2-4431	100	2-4432	100	2-4433	100	2-4474	100
100L	12	38	====	-	-	-	-	2-4443	100	2-4474	100
100	12	38	====	2-4434	100	2-4435	100	2-4436	100	2-4474	100

Soporta temperaturas de hasta +250°C en intervalos de 30 min.

Rueda TA

Acero

130 - 400 kg



VENTAJAS DEL ARO

- Facilidad de desplazamiento +
- Ruido durante la marcha +
- Protección del suelo +

-90° a +600°

Más información en página 288

BLOQUEO DIRECCIONAL



			Cojinete Eje	Código	KG	Código	KG	Código	KG	Código	KG
80	10	34	====	2-2506	130	2-2509	130	2-2512	130	-	-
80	12	34	====	-	-	-	-	2-4072	130	-	-
100L	10	34	====	2-2507	150	2-2510	150	2-2513	150	-	-
100L	12	34	====	-	-	-	-	2-4133	150	-	-
100	12	34	====	2-2508	200	2-2511	200	2-2514	180	-	-
150	12	50	====	2-2515	350	2-2517	350	2-2519	250	2-3347	350
200	12	50	====	2-2516	400	2-2518	400	2-2520	300	2-3348	400

Para temperaturas superiores a 200° reducir carga (kg) un 40%

Accesorio protección **pie rígido**



Código

150	2-3653
160	2-3653
200	2-3654

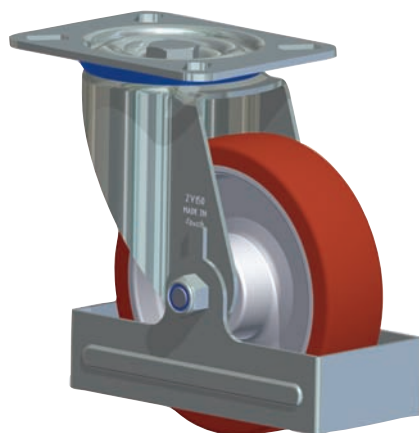

Para solicitar la protección pie, añadir a la rueda solicitada el código correspondiente.

**PROTECCIÓN
PIE**



Accesorio protección **flexible**



Código

150	2-4036
160	2-4036
200	2-4037



Para solicitar la protección pie, añadir a la rueda solicitada el código correspondiente.

**PROTECCIÓN
PIE**



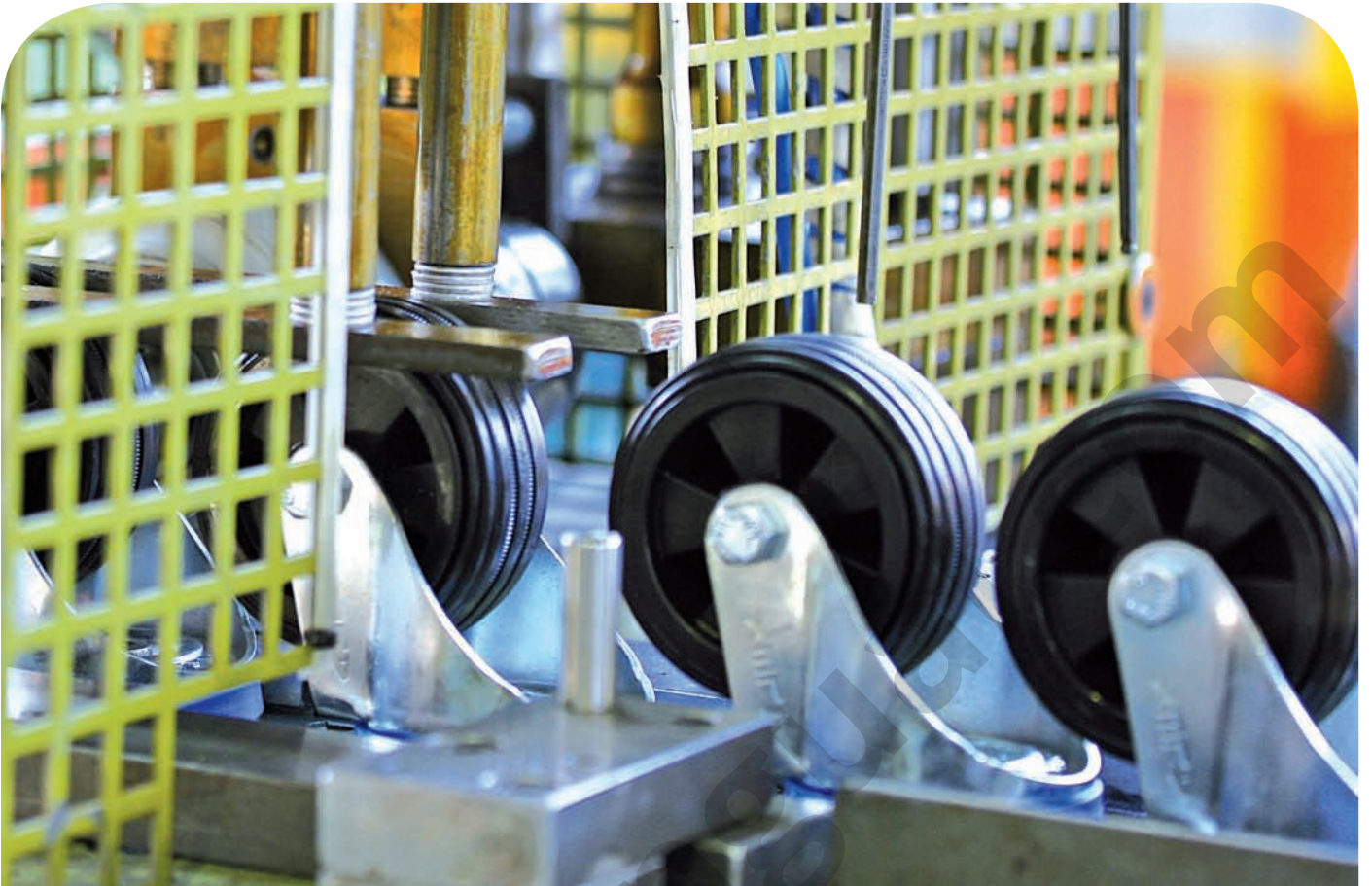

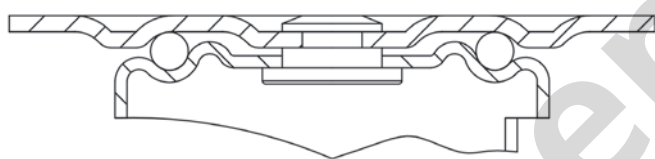

50 - 475 kg 50 a 125 mm

- » Acabado cincado
- » Fabricadas según normas europeas EN 12532

DETALLES DEL PRODUCTO

- ✓ Horquilla construida para trabajos duros.
- ✓ Con chapa de acero hasta 4 m/m de espesor y pista de rodadura de gran dimensión.
- ✓ La robusta construcción de la horquilla ofrece una combinación de alta eficacia, larga duración y excelente rendimiento.

Medidas Generales

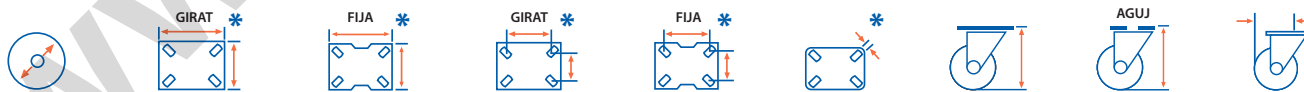

50	67x48	67x48	54x24	54x24	6	63	-	43
60	95x70	112x57	76x44,5	89x27	8	84	-	54
80	105x80	102x64	86/80x60	83x35	8	97	-	62
100	128x102	121x80	105x80/100x76	100x48	10	125	-	76
125	162x133	121x80	140x105/120x95	100x48	10	156	-	98

* Detalle de planos de platina, ver página 25 y 26

Rueda HG

Goma negra natural

180 - 225 kg



VENTAJAS DEL ARO

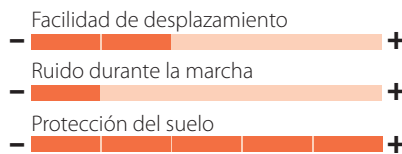

-20° a +60°

Más información en página 270



Cojinete
Eje

100	38	
125	38	

Código



4-1295	180
4-1297	225

Código



4-1296	180
4-1298	225

Código



4-0514	200
4-0516	250

Rueda PO

Poliuretano inyectado

300 - 450 kg



VENTAJAS DEL ARO

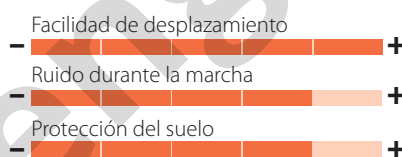

-25° a +80°

Más información en página 281



Cojinete
Eje

125	42	
125	42	

Código



4-0263	300
4-0264	300

Código



4-0265	300
4-0231	300

Código



4-0480	300
4-0481	300

Rueda HU

Poliuretano fundido

340 - 400 kg



VENTAJAS DEL ARO

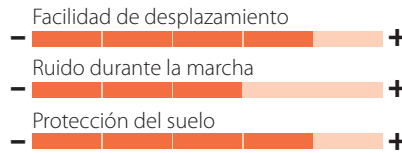

-20° a +60°

Más información en página 278



Cojinete
Eje

100	40	
125	40	

Código



4-0270	340
4-0272	400

Código



4-0271	340
4-0273	400

Código



2-1746	350
2-1747	400

Rueda FT

Nylon extrafuerte

50 - 475 kg



VENTAJAS DEL ARO

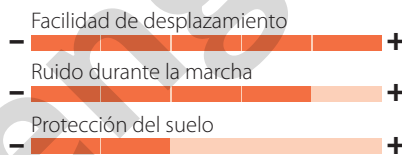

-30° a +80°

Más información en página 284



Cojinete
Eje

50	19	
60	22	
80	30	
100	32	
100	32	
125	42	
125	42	

Código



4-0096	50
4-0097	125
4-0098	220
4-0099	340
4-0100	340
4-0101	475
4-0102	475

Código



4-0109	50
4-0110	125
4-0111	220
4-0112	340
4-0113	340
4-0114	475
4-0115	475

Código



4-0001	50
4-0002	125
4-0003	300
4-1535	400
4-0005	400
4-0007	600
4-0008	600

Rueda TA

Acero

220 - 475 kg



VENTAJAS DEL ARO

- Facilidad de desplazamiento **+**
- Ruido durante la marcha **+**
- Protección del suelo **+**

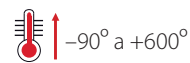

Más información en página 288



Cojinete Eje

80	34	—
100	40	●●
125	45	●●

Código



4-0276	220
4-0106	340
4-0279	475

Código



4-0277	220
4-0119	340
4-0281	475

Código



2-0072	300
4-0556	450
4-0558	630

Las versiones con cojinetes de bolas, deben trabajar en un rango de temperatura: **-40° a +150°**

Para temperaturas superiores a 200° reducir carga (kg) un 40%



NOVEDAD

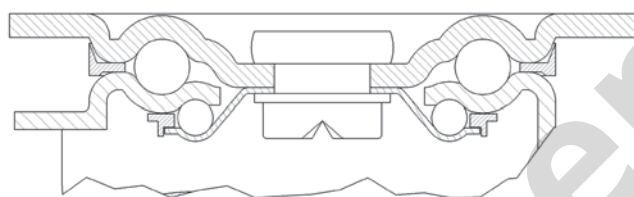

DETALLES DEL PRODUCTO

- ✓ Fabricada con chapa zincada de hasta 2 m/m de espesor y para ruedas pintadas en negro pletina de chapa de 4 m/m y carcasa de 3 m/m.
- ✓ Combinación de cojinetes de doble hilera de bolas (de acero al cromo protegidas por cazoletas envolventes).

100 - 600 kg **35 a 75 mm**

- » Acabado cincado plateado ó pintado en negro
- » Fabricadas según normas europeas EN 12528 - EN 12532

Medidas Generales

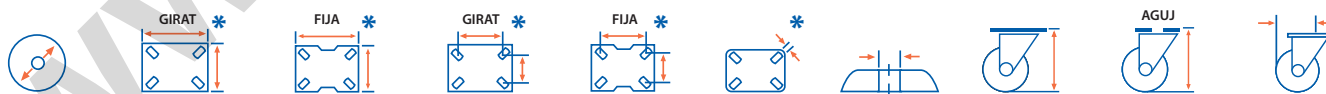

35	60x48	-	48x35	-	6	10	67	59	31
50	84x84	84x84	64x64	64x64	8	-	78	-	40
65	106x85	106x85	81x60	81x60	9	-	95	-	57
75	106x85	106x85	81x60	81x60	9	-	105	-	59

* Detalle de planos de platina, ver página 27

Rueda VN

Poliuretano

100 kg

NOVEDAD

VENTAJAS DEL ARO

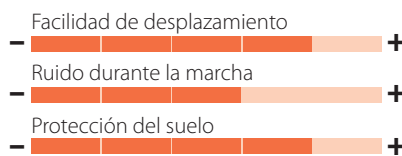

🌡️ -20° a +60°

Más información en página 292

		Cojinete
		Eje
35	27	



Código	
2-4541	100



Código	
2-4668	100

		Cojinete
		Eje
35	27	



Código	
2-4540	100



Código	
2-4667	100



Código	
2-4669	100

Rueda KN

Nylon

300 - 600 kg

NOVEDAD

VENTAJAS DEL ARO

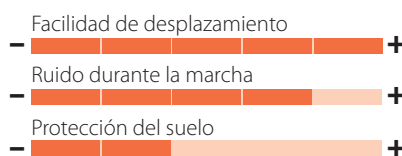

🌡️ -30° a +80°

		Cojinete
		Eje
50	38	
65	50	
75	50	



Código	
2-4542	300
2-4545	500
2-4548	600



Código	
2-4543	300
2-4546	500
2-4549	600



Código	
2-4544	300
2-4547	500
2-4550	600

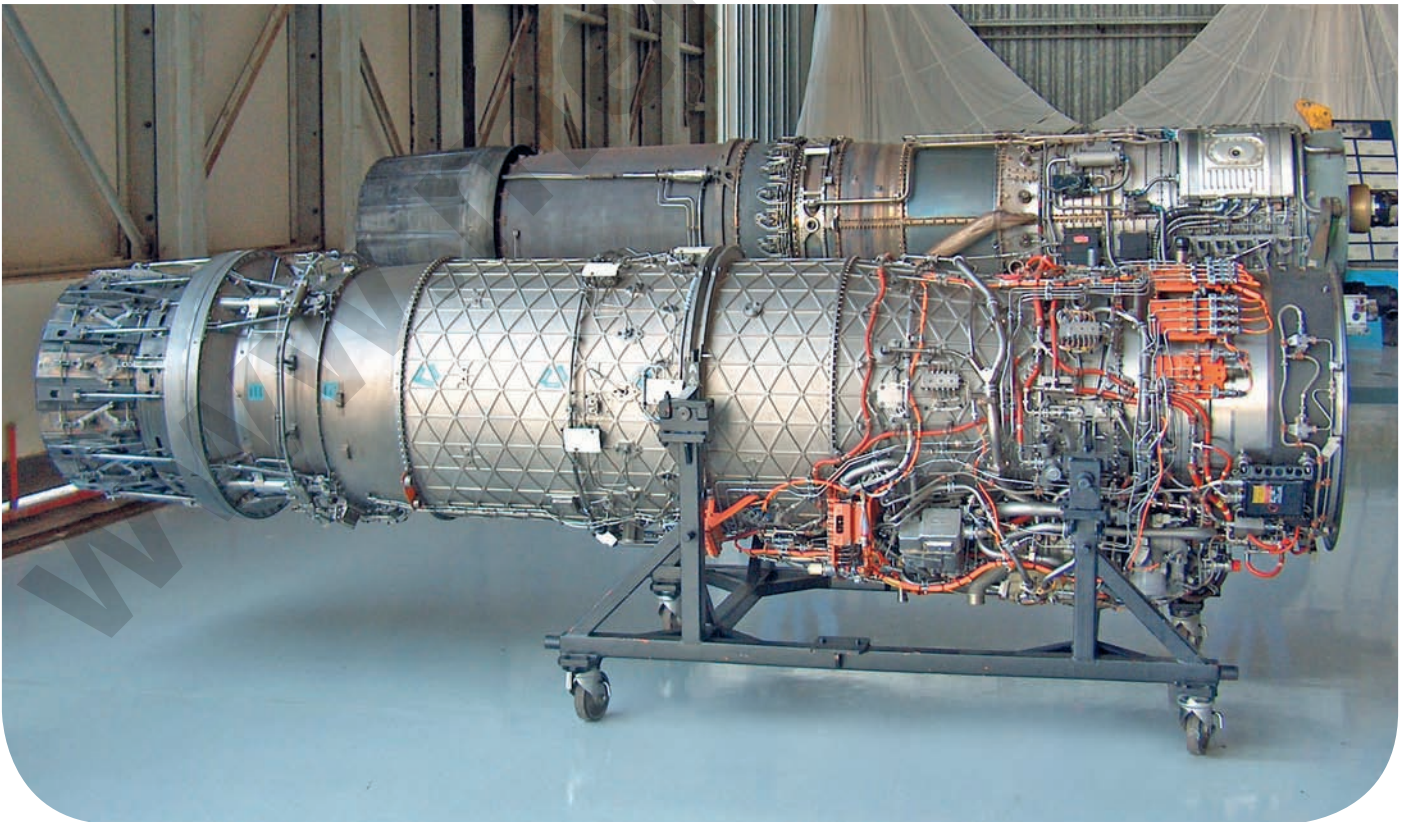

Ruedas para andamios y construcción

Hasta 700 kg por rueda

ÍNDICE

- Serie **TVA** pág. 146
- Serie **TC** pág. 148
- Serie **ZVA** pág. 150



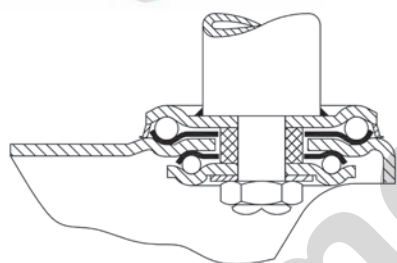
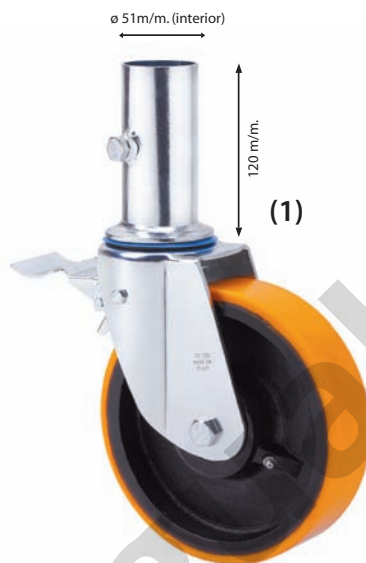
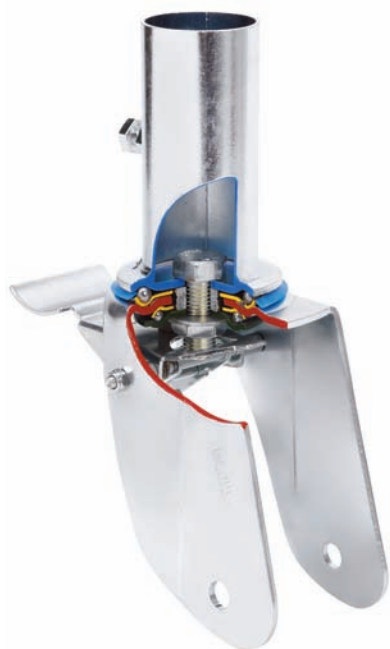

DETALLES DEL PRODUCTO

- ✓ Fabricada con chapa de acero embutida hasta 4 m/m de espesor.
- ✓ Freno de doble acción regulable.
- ✓ Gran capacidad de carga.
- ✓ Las cargas indicadas en catálogo son para andamios de altura máxima de 4 metros y suelos estables.

650 - 700 kg **200 mm**

- » Acabado cincado brillante de alta resistencia al óxido.
- » Fabricadas según normas europeas EN 12532

Medidas Generales

200	-	-	-	51x120	40x135	246	-	155

Rueda TN

Nylon blanco

650 kg



VENTAJAS DEL ARO

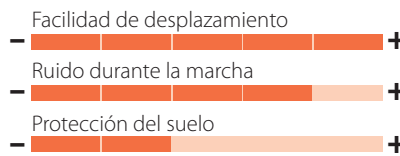

Temperatura: -30° a +80°

Más información en página 285



(1)



(2)



200



50

Cojinete
Eje

Código

2-2495



650

Código

2-2494



650

Rueda HU

Poliuretano fundido

700 kg



VENTAJAS DEL ARO

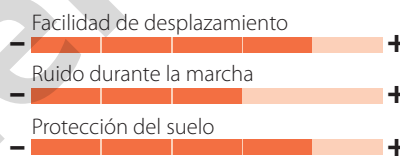

Temperatura: -20° a +60°

Más información en página 278



(1)



(2)



200



50

Cojinete
Eje

Código

2-2497



700

Código

2-2496



700



DETALLES DEL PRODUCTO

- ✓ Fabricada con chapa de acero embutida hasta 4 m/m de espesor.
- ✓ Freno de doble acción regulable.
- ✓ Gran capacidad de carga.
- ✓ Las cargas indicadas en catálogo son para andamios de altura máxima de 4 metros y suelos estables.
- ✓ Espiga roscada 500 mm.

300 - 400 kg	200 mm
---------------------	---------------

- » Acabado cincado brillante de alta resistencia al óxido.
- » Fabricadas según normas europeas EN 12532

Medidas Generales

200	-	-	-	-	40x500	240	-	-

Rueda PO

Poliuretano fundido

300 kg



VENTAJAS DEL ARO

- +
- +
- +

-25° a +80°

Más información en página 281

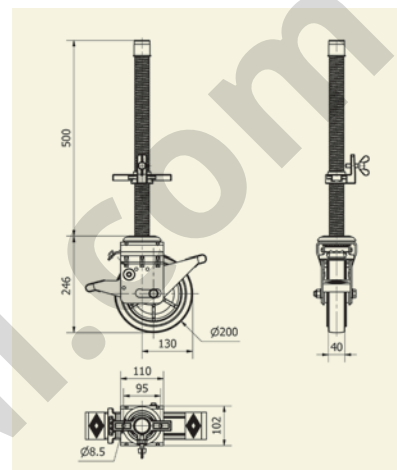

200



40

Cojinete Eje

Código

2-3788



300

Rueda TN

Nylon blanco

400 kg



VENTAJAS DEL ARO

- +
- +
- +

-30° a +80°

Más información en página 285

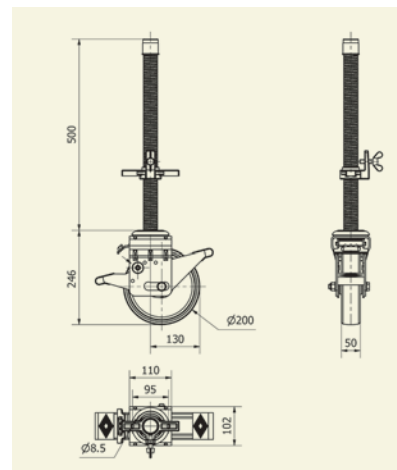

200



50

Cojinete Eje

Código

2-3787



400

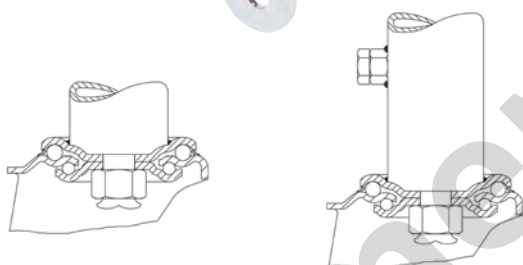
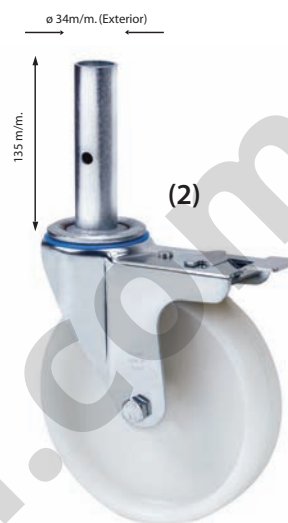
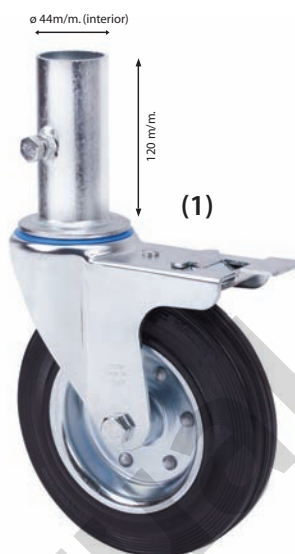

DETALLES DEL PRODUCTO

- ✓ Fabricada con chapa de acero embutida hasta 3 m/m de espesor.
- ✓ Freno de doble acción.
- ✓ Gran capacidad de carga.
- ✓ Las cargas indicadas en catálogo son para andamios de altura máxima de 4 metros y suelos estables.

	215 - 350 kg		200 mm
--	---------------------	--	---------------

- » Acabado cincado.
- » Fabricadas según normas europeas EN 12532

Medidas Generales

200	-	-	-	4x120	34x135	234	-	155

Rueda BS

Goma natural

230 kg



VENTAJAS DEL ARO

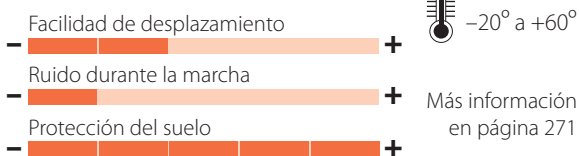

Rueda PS

Goma natural

215 kg



VENTAJAS DEL ARO



Cojinete Eje

200	46	
200	47	

Código



230

Código



230

Código



215

Código



215

2-0905

2-0917

2-0906

2-0918

Rueda TN

Nylon blanco

350 kg



VENTAJAS DEL ARO

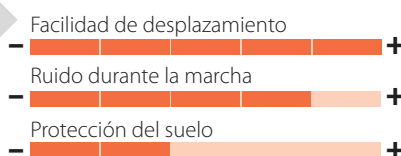

Más información en página 285

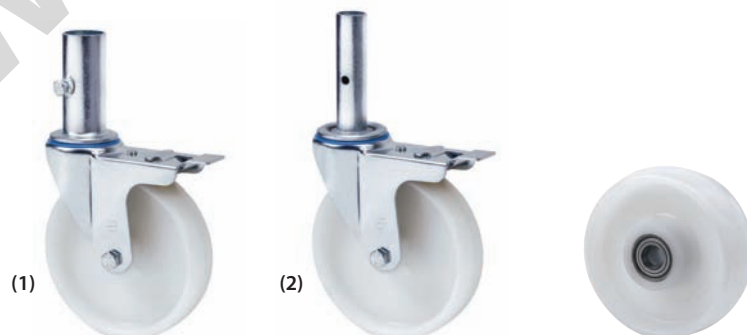

Cojinete Eje

200	50	
-----	----	--

Código



350

Código



350

Código



750

2-0903

2-0915

2-0071

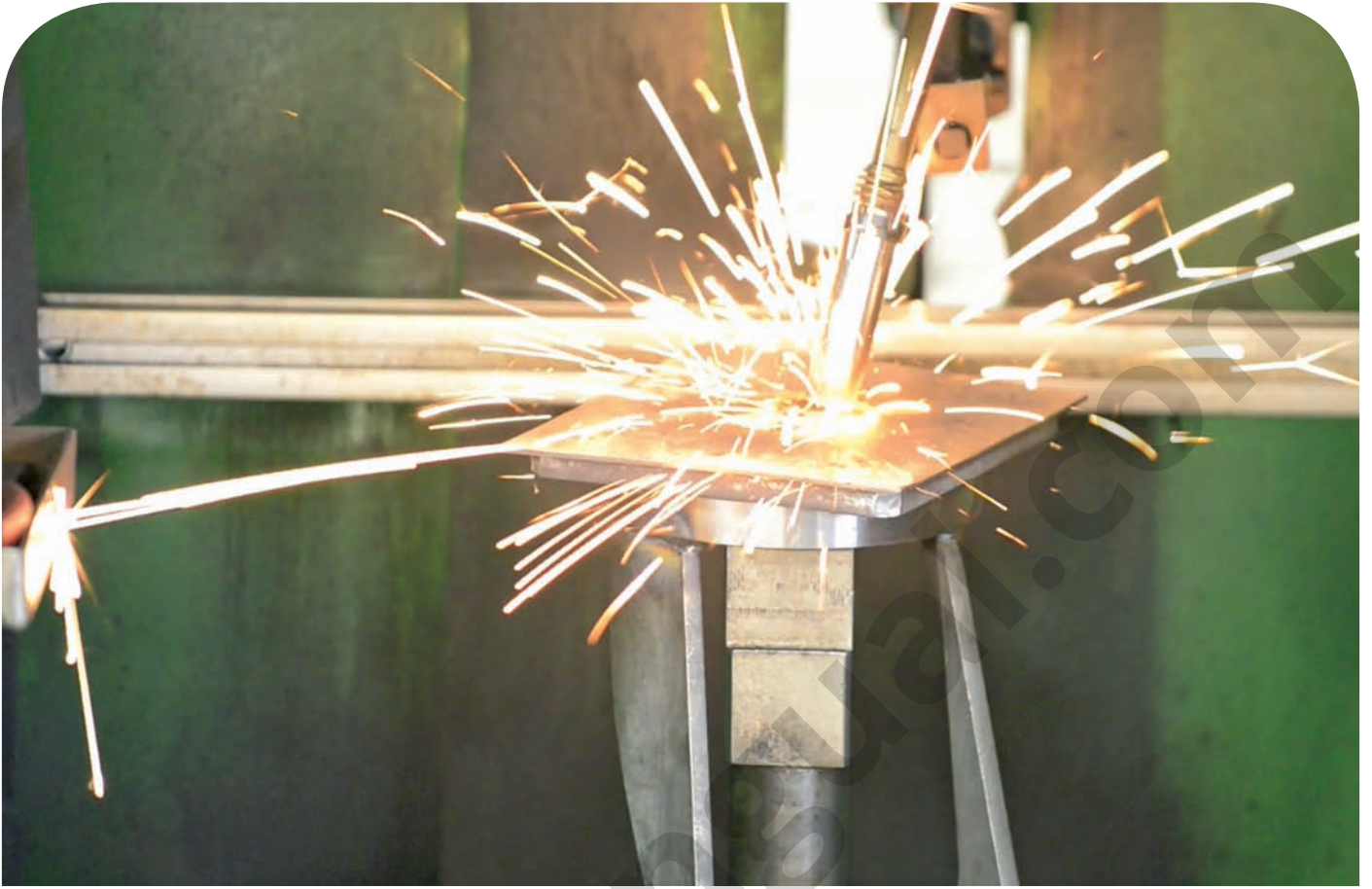

Ruedas de acero inoxidable

Hasta 600 kg por rueda

ÍNDICE

- * **AMPLIAMOS GAMA** • Serie **ZVI** pág. 154
- Serie **ZLI** pág. 172
- * **AMPLIAMOS GAMA** • Serie **BHI** pág. 176



SERIE

ZVI INOX



NOVEDAD

AISI INOX 304

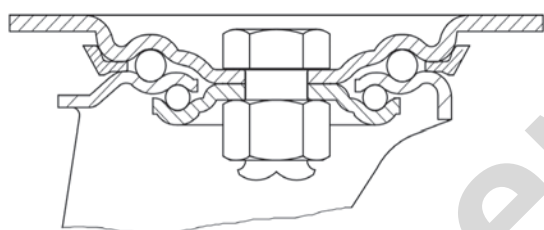

DETALLES DEL PRODUCTO

- ✓ Cabezal giratorio construido con doble hilera de bolas endurecidas.
- ✓ Fabricada con chapa de acero inoxidable (AISI 304).
- ✓ Hasta 3 m/m de espesor.
- ✓ Especialmente recomendada para usos industriales en el exterior, factorías de alimentación, carros de hostelería y sector químico.

40 - 600 kg **60 a 200 mm**

» Fabricadas según normas europeas EN12530/ 12532

Medidas Generales

	GIRAT *	FIJA *	GIRAT *	FIJA *				AGUJ	
60	70x55	57x52	55x42	42x26	8	-	84	-	59
80	105x80	107x86	86/80x60	80x60	8	10/12	110	104	77
100L	105x80	107x86	86/80x60	80x60	8	10/12	131	124	91
100	106x86	107x86	86/80x60	80x60	8	12	133	128	94
125L	105x80	107x86	86/80x60	80x60	8	10/12	155	148	104
125	106x86	107x86	86/80x60	80x60	8	12	155	151	107
150	140x110	136x116	105x80	105x80	10	12	196	190	128
160	140x110	136x116	105x80	105x80	10	12	205	199	131
200	140x110	136x116	105x80	105x80	10	12	242	236	155

* Detalle de planos de platina, ver página 28

Rueda PS

Goma negra natural

75 - 215 kg



VENTAJAS DEL ARO

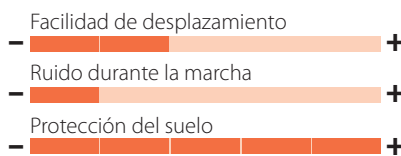

🌡️ -20° a +60°

Más información en página 276



Cojinete Eje

80	25	---
100L	28	---
100	28	---
125L	35	---
125	35	---
160	40	---
160	40	⊠*
200	47	---
200	47	⊠*

Código	KG
2-1669	75
2-1841	100
2-1670	100
* 2-4923	125
2-1671	125
2-1186	160
* 2-4743	160
2-1188	215
* 2-4748	215

Código	KG
2-1672	75
2-1843	100
2-1673	100
* 2-4924	125
2-1674	125
2-1187	160
* 2-4744	160
2-1189	215
* 2-4749	215

Código	KG
2-2339	75
2-1898	100
2-1679	100
* 2-4925	125
2-1680	125
2-1684	160
* 2-4745	160
2-1685	215
* 2-4750	215

Código	KG
2-0848	75
2-0849	100
2-0849	100
2-0850	125
2-0850	125
2-0852	160
* 2-4739	160
2-0853	215
* 2-4740	215

*cojinete de rodillos inoxidable

75 - 215 kg



Cojinete Eje

80	10	25	---
80	12	25	---
100L	10	28	---
100L	12	28	---
100	12	28	---
125L	12	35	---
125	12	35	---
160	12	40	---
160	12	40	⊠*
200	12	47	---
200	12	47	⊠*

Código	KG
2-1675	75
2-4134	75
2-1899	100
2-4135	100
2-1676	100
* 2-4926	125
2-1677	125
2-1407	160
* 2-4746	160
2-1408	215
* 2-4751	215

Código	KG
2-2344	75
2-4136	75
2-1900	100
2-4137	100
2-1682	100
* 2-4927	125
2-1683	125
2-1686	160
* 2-4747	160
2-1687	215
* 2-4752	215

Código	KG
2-0848	75
2-0848	75
2-0849	100
2-0849	100
2-0849	100
2-0850	125
2-0850	125
2-0852	160
* 2-4739	160
2-0853	215
* 2-4740	215

*cojinete de rodillos inoxidable

Rueda PGA

Goma gris natural
40 - 135 kg



VENTAJAS DEL ARO

- Facilidad de desplazamiento
- Ruido durante la marcha
- Protección del suelo

-20° a +60°

Más información en página 272



*** AMPLIAMOS GAMA**



		Cojinete Eje
60	22	---
80	32	---
100L	32	---
100	32	---
125L	32	---
125	32	---

Código	
2-1327	40
2-1319	80
2-1724	110
2-1182	110
* 2-4928	135
2-1184	135

Código	
2-1328	40
2-1320	80
2-1725	110
2-1183	110
* 2-4929	135
2-1185	135

Código	
-	-
2-2348	80
2-1835	110
2-1662	110
* 2-4930	135
2-1663	135

Código	
2-1064	40
2-1312	80
2-0784	110
2-0784	110
2-0790	135
2-0790	135

80 - 135 kg

*** AMPLIAMOS GAMA**



			Cojinete Eje
80	10	32	---
80	12	32	---
100L	10	32	---
100L	12	32	---
100	12	32	---
125L	12	32	---
125	12	32	---

Código	
2-1404	80
2-4138	80
2-1830	110
2-4139	110
2-1405	110
* 2-4931	135
2-1406	135

Código	
2-2353	80
2-4140	80
2-1836	110
2-4141	110
2-1666	110
* 2-4932	135
2-1667	135

Código	
2-1312	80
2-1312	80
2-0784	110
2-0784	110
2-0784	110
* 2-0790	135
2-0790	135

Rueda PS gris

Goma gris natural

160 - 215 kg



VENTAJAS DEL ARO

- Facilidad de desplazamiento
- Ruido durante la marcha
- Protección del suelo

-20° a +60°

Más información en página 277



Cojinete Eje

Diámetro	Altura	Cojinete Eje
160	40	—
160	40	*
200	47	—
200	47	*

Código	KG
2-3417	160
* 2-4753	160
2-3418	215
* 2-4758	215

Código	KG
2-3419	160
2-4754	160
2-3420	215
2-4759	215

Código	KG
2-3421	160
2-4755	160
2-3422	215
2-4760	215

Código	KG
2-3397	160
2-4741	160
2-3395	215
2-4742	215

*cojinete de rodillos inoxidable

160 - 215 kg



Cojinete Eje

Diámetro	Altura	Cojinete Eje
160	12	40
160	12	40
200	12	47
200	12	47

Código	KG
2-3423	160
* 2-4756	160
2-3424	215
* 2-4761	215

Código	KG
2-3425	160
* 2-4757	160
2-3426	215
* 2-4762	215

Código	KG
2-3397	160
* 2-4741	160
2-3395	215
* 2-4742	215

*cojinete de rodillos inoxidable

Rueda PGZ

Goma gris inyectada

80 - 180 kg



VENTAJAS DEL ARO

- Facilidad de desplazamiento +
- Ruido durante la marcha +
- Protección del suelo +

🌡️ -20° a +60°

Más información en página 275



*** AMPLIAMOS GAMA**



Cojinete Eje

80	28	—
80	28	📏*
100L	30	—
100L	30	📏*
100	30	—
100	30	📏*
125L	32	—
125L	32	📏*
125	32	—
125	32	📏*
160	38	—
200	45	—

Código	KG	Código	KG	Código	KG
2-3260	80	2-3270	80	2-3280	80
* 2-3261	80	* 2-3271	80	* 2-3281	80
2-3262	100	2-3272	100	2-3282	100
* 2-3263	100	* 2-3273	100	* 2-3283	100
2-3264	100	2-3274	100	2-3284	100
* 2-3265	100	* 2-3275	100	* 2-3285	100
* 2-4933	120	* 2-4934	120	* 2-4935	120
* 2-4938	120	* 2-4939	120	* 2-4940	120
2-3266	120	2-3276	120	2-3286	120
* 2-3267	120	* 2-3277	120	* 2-3287	120
2-3268	160	2-3278	160	2-3288	160
2-3269	180	2-3279	180	2-3289	180

*cojinete de rodillos inoxidable

Rueda PGZ

Goma gris inyectada

80 - 180 kg



VENTAJAS DEL ARO

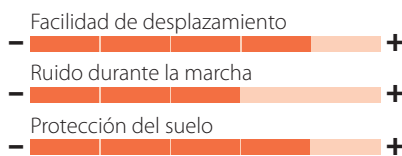

—20° a +60°

Más información en página 275



*** AMPLIAMOS GAMA**



Cojinete Eje

80	10	28	—
80	12	28	—
80	10	28	—*
80	12	28	—*
100L	10	30	—
100L	12	30	—
100L	10	30	—*
100L	12	30	—*
100	12	30	—
100	12	30	—*
125L	12	32	—
125L	12	32	—*
125	12	32	—
125	12	32	—*
160	12	38	—
200	12	45	—

Código



2-3290	80
2-4142	80
2-3291	80
2-4571	80
2-3292	100
2-4143	100
2-3293	100
2-4575	100
2-3294	100
2-3295	100
2-4936	120
2-4941	120
2-3296	120
2-3297	120
2-3298	160
2-3299	180

Código



2-3300	80
2-4144	80
2-3301	80
2-4572	80
2-3302	100
2-4145	100
2-3303	100
2-4576	100
2-3304	100
2-3305	100
2-4937	120
2-4942	120
2-3306	120
2-3307	120
2-3308	160
2-3309	180

Código



2-3142	80
2-3142	80
2-3310	80
2-3310	80
2-3143	100
2-3143	100
2-3311	100
2-3311	100
2-3143	100
2-3311	100
2-3144	120
2-3312	120
2-3144	120
2-3312	120
2-3145	160
2-3146	180

*cojinete de rodillos inoxidable

Rueda PO

Poliuretano inyectado

130 - 600 kg



VENTAJAS DEL ARO

- Facilidad de desplazamiento +
- Ruido durante la marcha +
- Protección del suelo +

-25° a +80°

Más información en página 281



Cojinete Eje

80	32	---
100L	33	---
100	33	---
150	42	---
200	50	---

✳

Código	KG
2-4691	130
2-1722	150
2-1170	200
2-1174	400
2-1176	600

✳

Código	KG
2-4692	130
2-1723	150
2-1171	200
2-1175	400
2-1177	600

✳

Código	KG
2-4693	130
2-1839	150
2-1652	200
2-1654	400
2-1655	600

✳

Código	KG
2-4673	150
2-1443	200
2-1443	200
4-0482	450
4-0486	600

Serie ZVI INOX



Rueda PO

Poliuretano inyectado

130 - 400 kg



VENTAJAS DEL ARO

- Facilidad de desplazamiento +
- Ruido durante la marcha +
- Protección del suelo +

-25° a +80°

Más información en página 281

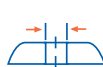

Cojinete Eje

80	10	32	==
80	12	32	==
100L	10	33	==
100L	12	33	==
100	12	33	==
150	12	42	==
200	12	50	==

Código	KG
* 2-4694	130
* 2-4696	130
2-1831	150
2-4158	150
2-1474	180
2-1410	300
2-1411	400

Código	KG
* 2-4695	130
* 2-4697	130
2-1840	150
2-4159	150
2-1656	180
2-1658	300
2-1659	400

Código	KG
* 2-4673	150
* 2-4673	150
2-1443	200
2-1443	200
2-1443	200
4-0482	450
4-0486	600

Rueda POL

Poliuretano inyectado

70 - 300 kg



VENTAJAS DEL ARO

- Facilidad de desplazamiento
- Ruido durante la marcha
- Protección del suelo

-25° a +80°

Más información en página 281



*** AMPLIAMOS GAMA**

Dureza 60° shore D



Cojinete
Eje

Diámetro	Altura	Cojinete
60*	22	—
80	32	—
80	32	—*
100L	32	—
100L	32	—*
100	32	—
100	32	—*
125L	32	—
125L	32	—*
125	32	—
125	32	—*
150	42	—
150	42	—*
200	50	—
200	50	—*

Código



Código	Peso (KG)
2-2633	70
2-2416	100
2-2929	100
2-2417	130
2-2975	130
2-2418	150
2-2930	150
* 2-4953	180
* 2-4958	180
2-2419	180
2-2931	200
2-2420	250
2-3469	250
2-2421	300
2-3470	300

Código



Código	Peso (KG)
2-2634	70
2-2422	100
2-2932	100
2-2423	130
2-2976	130
2-2424	150
2-2933	150
* 2-4954	180
* 2-4959	180
2-2425	180
2-2934	200
2-2426	250
2-3471	250
2-2427	300
2-3472	300

Código



Código	Peso (KG)
—	—
2-2428	100
2-2935	100
2-2429	130
2-2977	130
2-2430	150
2-2936	150
* 2-4955	180
* 2-4960	180
2-2431	180
2-2937	200
2-2432	250
2-3473	250
2-2433	300
2-3474	300

Código



Código	Peso (KG)
2-2521	70
2-2500	100
2-3493	100
2-2480	150
2-3494	150
2-2480	150
2-3494	150
2-2481	200
2-3495	200
2-2481	200
2-3495	200
2-2482	250
2-3445	250
2-2483	300
2-3446	300

*cojinete de rodillos inoxidable

*Aro: para diámetro 60 aro con núcleo de poliamix negro y banda de poliuretano rojo

Rueda POL

Poliuretano inyectado

100 - 300 kg



VENTAJAS DEL ARO

- Facilidad de desplazamiento
- Ruido durante la marcha
- Protección del suelo

-25° a +80°

Más información en página 281



*** AMPLIAMOS GAMA**

Dureza 60° shore D



Cojinete Eje

80	10	32	
80	10	32	
80	12	32	
80	10	32	*
80	12	32	*
100L	10	32	
100L	12	32	
100L	10	32	
100L	12	32	*
100	12	32	
100	12	32	*
125L	12	32	
125L	12	32	*
125	12	32	
125	12	32	*
150	12	42	
150	12	42	*
200	12	50	
200	12	50	*

Código



Código	KG
2-2434	100
2-4160	100
2-2938	100
2-4161	100
2-2435	130
2-4162	130
2-2978	130
2-4163	130
2-2436	150
2-2939	150
2-4956	180
2-4961	180
2-2437	200
2-2940	200
2-2438	250
2-3475	250
2-2439	300
2-3476	300

Código



Código	KG
2-2440	100
2-4164	100
2-2941	100
2-4165	100
2-2441	130
2-4166	130
2-2979	130
2-4167	130
2-2442	150
2-2942	150
2-4957	180
2-4962	180
2-2443	200
2-2943	200
2-2444	250
2-3477	250
2-3335	300
2-3478	300

Código



Código	KG
2-2500	100
2-2500	100
2-3493	100
2-3493	100
2-2480	150
2-2480	150
2-3494	150
2-3494	150
2-2480	150
2-2480	150
2-3494	150
2-3494	150
2-2481	200
2-3495	200
2-2481	200
2-3495	200
2-2482	250
2-3445	250
2-2483	300
2-3446	300

*cojinete de rodillos inoxidable

Rueda POA

Poliuretano inyectado blando

100 - 250 kg



VENTAJAS DEL ARO

- Facilidad de desplazamiento
- Ruido durante la marcha
- Protección del suelo

-25° a +80°

Más información en página 282



*** AMPLIAMOS GAMA**



Dureza 80° shore A



Cojinete Eje

80	32	
80	32	
100L	32	
100L	32	
100	32	
100	32	
125L	32	
125L	32	
125	32	
125	32	
150	42	
150	42	
200	50	
200	50	

Código	KG
2-2855	100
2-2944	100
2-2860	130
2-2980	130
2-2865	150
2-2945	150
* 2-4963	175
* 2-4968	175
2-2870	175
2-2946	175
2-2875	200
2-3479	200
2-2880	250
2-3480	250

Código	KG
2-2857	100
2-2947	100
2-2862	130
2-2981	130
2-2867	150
2-2948	150
* 2-4964	175
* 2-4969	175
2-2872	175
2-2949	175
2-2877	200
2-3481	200
2-2882	250
2-3482	250

Código	KG
2-2856	100
2-2950	100
2-2861	130
2-2982	130
2-2866	150
2-2951	150
* 2-4965	175
* 2-4970	175
2-2871	175
2-2952	175
2-2876	200
2-3483	200
2-2881	250
2-3484	250

Código	KG
2-2850	100
2-3202	100
2-2851	150
2-3203	150
2-2851	150
2-3203	150
2-2852	175
2-3204	175
2-2852	175
2-3204	175
2-2853	200
2-3447	200
2-2854	250
2-3448	250

*cojinete de rodillos inoxidable

▲ Rueda de poliuretano azul. **Desplazamiento más silencioso y absorción de vibraciones**

Rueda POA

Poliuretano inyectado blando

100 - 250 kg



VENTAJAS DEL ARO

Facilidad de desplazamiento	+
Ruido durante la marcha	+
Protección del suelo	+

🌡️ -25° a +80°

Más información en página 282



* **AMPLIAMOS GAMA**

Dureza 80° shore A

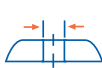

Cojinete Eje

80	10	32	Cojinete Eje
80	10	32	—
80	12	32	—
80	10	32	▬*
80	12	32	▬*
100L	10	32	—
100L	12	32	—
100L	10	32	▬*
100L	12	32	▬*
100	12	32	—
100	12	32	▬*
125L	12	32	—
125L	12	32	▬*
125	12	32	—
125	12	32	▬*
150	12	42	—
150	12	42	▬*
200	12	50	—
200	12	50	▬*

Código



2-2858	100
2-4168	100
2-2953	100
2-4169	100
2-2863	130
2-4170	130
2-2983	130
2-4171	130
2-2868	150
2-2954	150
* 2-4966	175
* 2-4971	175
2-2873	175
2-2955	175
2-2878	200
2-3485	200
2-2883	250
2-3486	250

Código



2-2859	100
2-4172	100
2-2956	100
2-4173	100
2-2864	130
2-4174	130
2-2984	130
2-4175	130
2-2869	150
2-2957	150
* 2-4967	175
* 2-4972	175
2-2874	175
2-2958	175
2-2879	200
2-3487	200
2-2884	250
2-3488	250

Código



2-2850	100
2-2850	100
2-3202	100
2-3202	100
2-2851	150
2-2851	150
2-3203	150
2-3203	150
2-2851	150
2-2851	150
2-2852	175
2-2852	175
2-3204	175
2-2852	175
2-3204	175
2-2853	200
2-3447	200
2-2854	250
2-3448	250

*cojinete de rodillos inoxidable

▲ Rueda de poliuretano azul. **Desplazamiento más silencioso y absorción de vibraciones**

Rueda UT

Poliamix blanco

60 - 400 kg



VENTAJAS DEL ARO

- Facilidad de desplazamiento +
- Ruido durante la marcha +
- Protección del suelo +

🌡️ -20° a +60°

Más información en página 286



*** AMPLIAMOS GAMA**



Cojinete Eje

60	24	—
80	34	—
80	34	—*
100L	34	—
100L	34	—*
100	34	—
100	34	—*
125L	35	—
125L	35	—*
125	35	—
125	35	—*
150	45	—
200	50	—

Código



Código	KG
2-1314	60
2-1325	130
2-2772	130
2-1720	150
2-2773	150
2-1162	200
2-2775	200
* 2-4943	220
* 2-4948	220
2-1164	250
2-2776	250
2-1166	350
2-1168	400

Código



Código	KG
2-1315	60
2-1326	130
2-2777	130
2-1721	150
2-2778	150
2-1163	200
2-2779	200
* 2-4944	220
* 2-4949	220
2-1165	250
2-2780	250
2-1167	350
2-1169	400

Código



Código	KG
-	-
2-2414	130
2-2781	130
2-1837	150
2-2774	150
2-1642	200
2-2782	200
* 2-4945	220
* 2-4950	220
2-1643	250
2-2783	250
2-1644	350
2-1645	400

Código



Código	KG
1-0318	60
4-0023	200
4-0046	200
4-0024	220
4-0047	220
4-0024	220
4-0047	220
4-0025	250
4-0048	250
4-0025	250
4-0048	250
2-0434	420
4-0027	500

*cojinete de rodillos inoxidable

Rueda UT

Poliamix blanco

130 - 300 kg



VENTAJAS DEL ARO

- Facilidad de desplazamiento **+**
- Ruido durante la marcha **+**
- Protección del suelo **+**

🌡️ -20° a +60°

Más información en página 286



*** AMPLIAMOS GAMA**

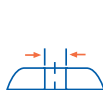

Cojinete Eje

80	10	34	—
80	12	34	—
80	10	34	—*
80	12	34	—*
100L	10	34	—
100L	12	34	—
100L	10	34	—*
100L	12	34	—*
100	12	34	—
100	12	34	—*
125L	12	35	—
125L	12	35	—*
125	12	35	—
125	12	35	—*
150	12	45	—
200	12	50	—

Código



2-1412	130
2-4146	130
2-2798	130
2-4147	130
2-1832	150
2-4148	150
2-2799	150
2-4149	150
2-1413	180
2-2800	180
* 2-4946	200
* 2-4951	200
2-1414	220
2-2801	220
2-1415	250
2-1416	300

Código



2-2415	130
2-4150	130
2-2802	130
2-4151	130
2-1838	150
2-4152	150
2-2803	150
2-4153	150
2-1648	180
2-2804	180
* 2-4947	200
* 2-4952	200
2-1649	220
2-2805	220
2-1650	250
2-1651	300

Código



4-0023	200
4-0023	200
4-0046	200
4-0046	200
4-0024	220
4-0024	220
4-0047	220
4-0047	220
4-0024	220
4-0047	220
4-0025	250
4-0048	250
4-0025	250
4-0048	250
2-0434	420
4-0027	500

*cojinete de rodillos inoxidable

Rueda FT

Nylon extrafuerte
200 - 600 kg



VENTAJAS DEL ARO

- Facilidad de desplazamiento +
- Ruido durante la marcha +
- Protección del suelo +

-30° a +80°

Más información en página 284



Cojinete Eje

80	30	---
100L	32	---
100	32	---
125	34	---
150	45	---
200	50	---

Código	KG
2-2682	200
2-2683	250
2-2684	300
2-2685	350
2-2686	600
2-2687	600

Código	KG
2-2688	200
2-2689	250
2-2690	300
2-2691	350
2-2692	600
2-2693	600

Código	KG
2-2694	200
2-2695	250
2-2696	300
2-2697	350
2-2698	600
2-2699	600

Código	KG
4-0003	300
4-1535	350
4-1535	350
4-1607	400
4-0009	900
4-0013	1.000

www.mengual.com

Rueda FT

Nylon extrafuerte
200 -400 kg



VENTAJAS DEL ARO

- Facilidad de desplazamiento +
- Ruido durante la marcha +
- Protección del suelo +

-30° a +80°

Más información
en página 284



Cojinete
Eje

80	10	30	—
80	12	30	—
100L	10	32	—
100L	12	32	—
100	12	32	—
125	12	34	—
150	12	45	—
200	12	50	—

Código



2-2700	200
2-4154	200
2-2701	225
2-4155	225
2-2702	270
2-2703	300
2-2704	375
2-2705	400

Código



2-2706	200
2-4156	200
2-2707	225
2-4157	225
2-2708	270
2-2709	300
2-2710	375
2-2711	400

Código



4-0003	300
4-0003	300
4-1535	350
4-1535	350
4-1535	350
4-1607	400
4-0009	900
4-0013	1.000

Rueda TD

Resina extrafuerte
200 - 600 kg



VENTAJAS DEL ARO

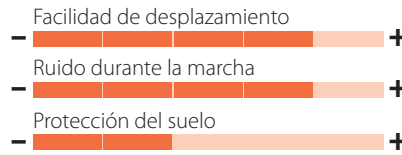

-40° a +200°

Más información en página 288

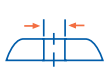

Cojinete
Eje

80	10	28	Cojinete Eje
80	12	28	Cojinete Eje
100L	10	32	Cojinete Eje
100L	12	32	Cojinete Eje
100	12	32	Cojinete Eje
150	12	42	Cojinete Eje
200	12	50	Cojinete Eje

Código	KG
2-1321	200
-	-
2-1718	250
-	-
2-1178	300
2-1180	600
2-4010	600

Código	KG
2-1322	200
-	-
2-1719	250
-	-
2-1179	300
2-1181	600
2-4011	600

Código	KG
2-1417	150
2-4176	150
2-1833	200
2-4177	200
2-1418	250
2-1477	400
2-4012	400

Código	KG
2-0063	280
2-0063	280
2-0064	425
2-0064	425
2-0064	425
2-0066	750
2-4002	900

Soporta temperaturas de hasta +200°C

Rueda TT

Resina alta temperatura
100 - 125 kg



VENTAJAS DEL ARO

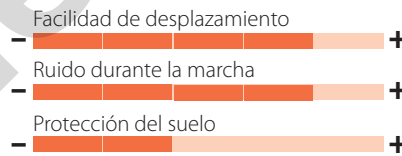

-30° a +280°

Más información en página 289

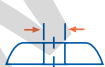

Cojinete
Eje

80	10	34	Cojinete Eje
80	12	34	Cojinete Eje
100L	10	34	Cojinete Eje
100L	12	34	Cojinete Eje
100	12	34	Cojinete Eje

Código	KG
2-1323*	100
-	-
2-1716*	125
-	-
2-1475*	125

Código	KG
2-1324*	100
-	-
2-1717*	125
-	-
2-1476*	125

Código	KG
2-1419*	100
2-4178*	100
2-1834*	125
2-4179*	125
2-1420*	125

Código	KG
2-1052*	100
2-1052*	100
2-1053*	125
2-1053*	125
2-1053*	125

* Con cojinete opcional de teflón. Código 2-1114

Soporta temperaturas de hasta +280°C en intervalos de 30 min.

Rueda THG

Goma negra

100 kg



VENTAJAS DEL ARO

- Facilidad de desplazamiento +
- Ruido durante la marcha +
- Protección del suelo +

-30° a +250°

Más información en página 289



NOVEDAD

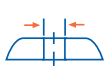

Cojinete Eje

Código



Código



Código



Código



100L	10	38	---	2-4437	100	2-4438	100	2-4439	100	2-4474	100
100L	12	38	---	-	-	-	-	2-4444	100	2-4474	100
100	12	38	---	2-4440	100	2-4441	100	2-4442	100	2-4474	100

Soporta temperaturas de hasta +250°C en intervalos de 30 min.



SERIE

ZLI INOX

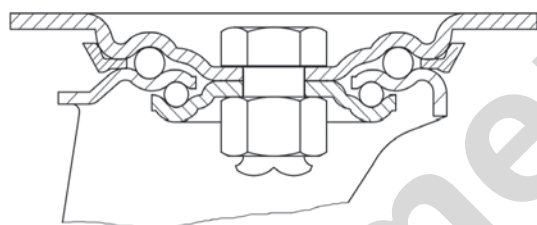

100 - 130 kg



80 a 125 mm

» Fabricadas según normas europeas EN 12530

DETALLES DEL PRODUCTO

- ✓ Fabricada con chapa de acero inoxidable (AISI 304).
- ✓ Hasta 2,5 m/m de espesor.
- ✓ Bolas y todos sus componentes de acero inoxidable.

Medidas Generales



	GIRAT *	FIJA *	GIRAT *	GIRAT *	GIRAT *	AGUJ	AGUJ	AGUJ
80	95X80	100X80	80X60	8	12	108	108	71
100	95X80	100X80	80X60	8	12	127	127	80
125	95X80	100X80	80X60	8	12	155	155	88

* Detalle de planos de platina, ver página 29

Rueda POL

Poliuretano inyectado

100 - 130 kg



VENTAJAS DEL ARO

- Facilidad de desplazamiento
- Ruido durante la marcha
- Protección del suelo

-25° a +80°

Más información en página 281



Dureza 60° shore D



Cojinete Eje

80	32	---
100	32	---
125	32	---

Código



2-3092	100
2-3093	120
2-3094	130

Código



2-3095	100
2-3096	120
2-3097	130

Código



2-3098	100
2-3099	120
2-3100	130

Código



2-2500	100
2-2480	150
2-2481	200

100 - 130 kg



Cojinete Eje

80	32	---
100	32	---
125	32	---

Código



2-3101	100
2-3102	120
2-3103	130

Código



2-3104	100
2-3105	120
2-3106	130

Código



2-2500	100
2-2480	150
2-2481	200



Rueda UT

Poliamix blando

100 - 120 kg



VENTAJAS DEL ARO

- Facilidad de desplazamiento
- Ruido durante la marcha
- Protección del suelo

-20° a +60°

Más información en página 286

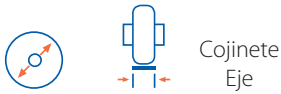

80	34	—
100	34	—
125	35	—

Código	KG
2-3077	100
2-3078	110
2-3079	120

Código	KG
2-3080	100
2-3081	110
2-3082	120

Código	KG
2-3083	100
2-3084	110
2-3085	120

Código	KG
4-0023	200
4-0024	220
4-0025	250

100 - 120 kg

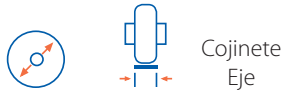

80	34	—
100	34	—
125	35	—

Código	KG
2-3086	100
2-3087	110
2-3088	120

Código	KG
2-3089	100
2-3090	110
2-3091	120

Código	KG
4-0023	200
4-0024	220
4-0025	250





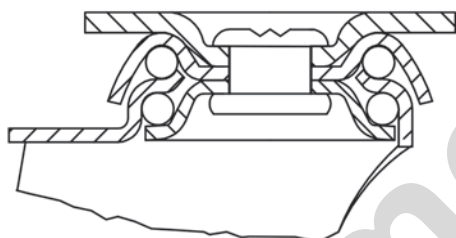

DETALLES DEL PRODUCTO

- ✓ Fabricada con chapa de acero inoxidable (AISI 304) hasta 2 m/m de espesor.
- ✓ Todos sus componentes de acero inoxidable.
- ✓ Soporte con doble rodamiento a bolas.
- ✓ Especialmente diseñada para usos de hostelería, hospitalarios, expositores, mostradores y decoración.

40 - 80 kg **60 a 100 mm**

» Fabricadas según normas europeas EN 12528 /12532

Medidas Generales

	GIRAT *	FIJA *	GIRAT *	*	*	*	AGUJ	*
60	70x55	75x66	54x38	6	10	88	85	62
80	70x55	75x66	54x38	6	10	112	108	77
100	70x55	75x66	54x38	6	10	134	130	90

* Detalle de planos de platina, ver página 29

Rueda PGI

Goma gris inyectada

40 - 70 kg



VENTAJAS DEL ARO

- Facilidad de desplazamiento +
- Ruido durante la marcha +
- Protección del suelo +

🌡️ -20° a +60°

Más información en página 273



*** AMPLIAMOS GAMA**



Cojinete Eje	
60	22
80	24
100	25

Código	KG
2-4333	40
2-3039	60
2-3040	70

Código	KG
2-4334	40
2-3041	60
2-3042	70

Código	KG
2-4509	40
2-3043	60
2-3044	70

Código	KG
2-1064	40
2-0806	60
2-0787	70

40 - 70 kg

*** AMPLIAMOS GAMA**



Cojinete Eje	
60	22
80	24
100	25

Código	KG
2-4508	40
2-3045	60
2-3046	70

Código	KG
2-4510	40
2-3047	60
2-3048	70

Código	KG
2-1064	40
2-0806	60
2-0787	70

Rueda PPI

Poliuretano inyectado

50 - 80 kg



VENTAJAS DEL ARO

- Facilidad de desplazamiento
- Ruido durante la marcha
- Protección del suelo

-25° a +80°

Más información en página 283



		Cojinete Eje
60	22	—
80	24	—
100	25	—

Código	
* 2-4335	50
2-3049	70
2-3050	80

Código	
* 2-4336	50
2-3051	70
2-3052	80

Código	
* 2-4512	50
2-3053	70
2-3054	80

Código	
2-2521	70
2-2477	80
2-2475	100

50 - 80 kg



		Cojinete Eje
60	22	—
80	24	—
100	25	—

Código	
* 2-4511	50
2-3055	70
2-3056	80

Código	
* 2-4513	50
2-3057	70
2-3058	80

Código	
2-2521	70
2-2477	80
2-2475	100

Rueda BP

Poliamix blanco

50 - 80 kg



VENTAJAS DEL ARO

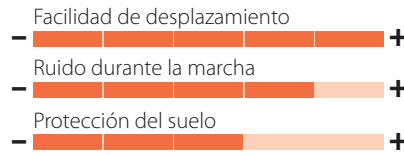

-20° a +80°

Más información en página 290



*** AMPLIAMOS GAMA**



Cojinete Eje

60	24	---
80	24	---
100	25	---

Código	KG
* 2-4339	50
2-3059	70
2-3060	80

Código	KG
* 2-4340	50
2-3061	70
2-3062	80

Código	KG
* 2-4515	50
2-3063	70
2-3064	80

Código	KG
1-0318	60
2-1926	70
4-0021	80

50 - 80 kg

*** AMPLIAMOS GAMA**



Cojinete Eje

60	24	---
80	24	---
100	25	---

Código	KG
* 2-4514	50
2-3065	70
2-3066	80

Código	KG
* 2-4516	50
2-3067	70
2-3068	80

Código	KG
1-0318	60
2-1926	70
4-0021	80



Ruedas para colectividades hostelería y mobiliario clínico

Hasta 125 kg
por rueda

ÍNDICE

	• Serie A	pág. 182
* AMPLIAMOS GAMA	• Serie BHA	pág. 188
	• Serie HC	pág. 192
NOVEDAD	• Serie HD	pág. 194
	• Serie AN	pág. 196
	• Serie HP	pág. 198
	• Serie M	pág. 202
	• Serie BH	pág. 204
	• Serie IG	pág. 210
* AMPLIAMOS GAMA	• Serie I	pág. 212
	• Fijaciones	pág. 215



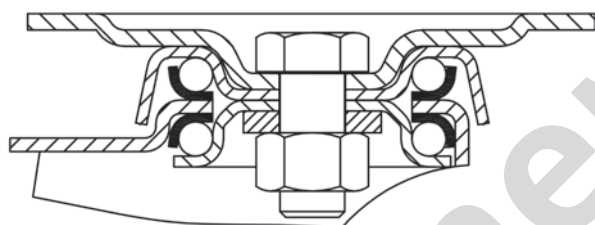

DETALLES DEL PRODUCTO

- ✓ Fabricado con chapa de acero hasta 2,5 m/m de espesor.
- ✓ Soporte con doble rodamiento a bolas con pistas complementarias endurecidas.
- ✓ Con antihilos de serie
- ✓ Diseñado para usos hospitalarios, hostelería y similares.

80 - 125 kg **80 a 200 mm**

- » Acabado cromado espejo
- » Fabricadas según normas europeas EN 12532

Medidas Generales

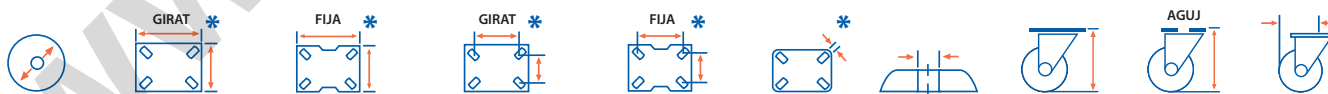

	GIRAT *	FIJA *	GIRAT *	FIJA *				AGUJ	
80	107x86	107x86	86/80x60	80x60	8	12	119	113	83
100	107x86	107x86	86/80x60	80x60	8	12	142	137	94
125	107x86	107x86	86/80x60	80x60	8	12	168	162	112
150	107x86	107x86	86/80x60	80x60	8	12	193	187	131
200	107x86	107x86	86/80x60	-	8	12	243	235	157

* Detalle de planos de platina, ver página 30

Rueda PGAIB

Goma gris inyectada

100 - 125 kg



VENTAJAS DEL ARO

- Facilidad de desplazamiento +
- Ruido durante la marcha +
- Protección del suelo +

-20° a +60°

Más información en página 273



Cojinete
Eje

100	32	
125	32	
150	32	

Código



2-2712	100
2-2666	125
2-3578	125

Código



2-2713	100
2-2667	125
2-3579	125

Código



2-2714	100
2-2668	125
2-3580	125

Código



2-2759	100
2-1146	125
2-3577	125

100 - 125 kg



Cojinete
Eje

100	32	
125	32	
150	32	

Código



2-2715	100
2-2669	125
2-3581	125

Código



2-2716	100
2-2670	125
2-3582	125

Código



2-2759	100
2-1146	125
2-3577	125

Rueda PGA

Goma gris natural

80 - 125 kg



VENTAJAS DEL ARO

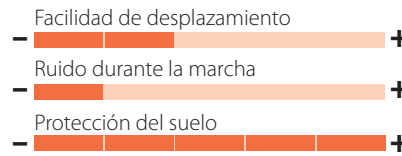

-20° a +60°

Más información en página 272



Cojinete Eje

80	32	---
80	32	●●
100	32	---
100	32	●●
125	32	---
125	32	●●
150	32	---
150	32	●●
200	32	●●

Código	KG
2-1486	80
2-1422	80
2-0259	100
2-1126	100
2-0188	125
2-1127	125
2-1227	125
2-1231	125
2-1565	125

Código	KG
2-1421	80
2-1423	80
2-0260	100
2-1130	100
2-0189	125
2-1131	125
2-1230	125
2-1234	125
-	-

Código	KG
-	-
-	-
2-1208	100
2-1209	100
2-0656	125
2-1129	125
2-1229	125
2-1233	125
2-1566	125

Código	KG
2-1312	80
2-0807	80
2-0784	110
2-1124	110
2-0790	135
2-1125	135
2-1252	140
2-1253	140
2-1569	160

80 - 125 kg



Cojinete Eje

80	32	---
80	32	●●
100	32	---
100	32	●●
125	32	---
125	32	●●
150	32	---
150	32	●●
200	32	●●

Código	KG
2-1424	80
2-1425	80
2-0265	100
2-1132	100
2-0267	125
2-1133	125
2-1235	125
2-1238	125
2-1567	125

Código	KG
-	-
-	-
2-1210	100
2-1211	100
2-0660	125
2-1135	125
2-1237	125
2-1240	125
2-1568	125

Código	KG
2-1312	80
2-0807	80
2-0784	110
2-1124	110
2-0790	135
2-1125	135
2-1252	140
2-1253	140
2-1569	160

Rueda PGC

Poliuretano gris conductivo

80 - 125 kg



VENTAJAS DEL ARO

- Facilidad de desplazamiento
- Ruido durante la marcha
- Protección del suelo

-25° a +80°

Más información en página 283



Cojinete
Eje

80	32	
100	32	
125	32	
150	32	

Código



2-1578	80
2-1579	100
2-1580	125
2-1581	125

Código



2-1588	80
2-1589	100
2-1590	125
2-1591	125

Código



-	-
2-1585	100
2-1586	125
2-1587	125

Código



2-1602	100
2-1603	175
2-1604	200
2-1605	200

80 - 125 kg



Cojinete
Eje

80	32	
100	32	
125	32	
150	32	

Código



2-1592	80
2-1593	100
2-1594	125
2-1595	125

Código



-	-
2-1599	100
2-1600	125
2-1601	125

Código



2-1602	100
2-1603	175
2-1604	200
2-1605	200

Rueda PU

Poliuretano inyectado

100 - 125 kg



VENTAJAS DEL ARO

- Facilidad de desplazamiento +
- Ruido durante la marcha +
- Protección del suelo +

-25° a +80°

Más información en página 283



100	32	
100	32	
125	32	
150	32	

Código	KG
2-1101	100
2-1039	125
2-3584	125

Código	KG
2-1102	100
2-1040	125
2-3585	125

Código	KG
2-1216	100
2-1042	125
2-3586	125

Código	KG
2-1100	175
2-1037	200
2-3583	200

100 - 125 kg

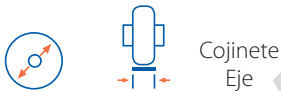

100	32	
100	32	
125	32	
150	32	

Código	KG
2-1103	100
2-1041	125
2-3587	125

Código	KG
2-1217	100
2-1043	125
2-3588	125

Código	KG
2-1100	175
2-1037	200
2-3583	200



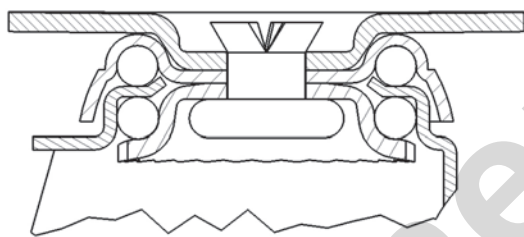

DETALLES DEL PRODUCTO

- ✓ Fabricada con chapa de acero de hasta 2 m/m de espesor.
- ✓ Soporte con doble rodamiento a bolas de gran tamaño.
- ✓ Acabado cincado brillante.
- ✓ Especialmente diseñado para usos de hostelería, hospitalarios, expositores, mostradores, decoración, etc.

90 - 100 kg
100 a 125 mm

- » Acabado cincado brillante
- » Fabricadas según normas europeas EN 12530

Medidas Generales

	GIRAT *	FIJA *	GIRAT *	*	*	AGUJ	*
100	80x70	-	60x50	8	10 / 12	132	87
125	80x70	-	60x50	8	10 / 12	163	105

* Detalle de planos de platina, ver página 30

Serie BHA

Rueda PGA

Goma gris natural

90 - 100 kg



VENTAJAS DEL ARO

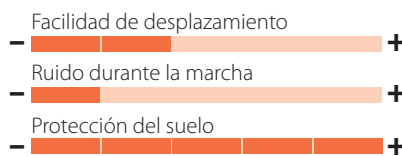

-20° a +60°

Más información en página 272

*** AMPLIAMOS GAMA**

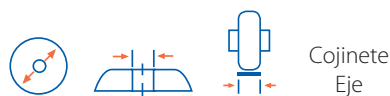

				Código	KG	Código	KG	Código	KG	Código	KG
100	10	32		2-4585	90	2-4586	90	2-4587	90	2-4588	90
100	12	32		-	-	-	-	2-4589	90	2-4590	90
100	10	32		2-4593	90	2-4594	90	2-4595	90	2-4596	90
100	12	32		-	-	-	-	2-4597	90	2-4598	90
125	10	32		2-1434	100	2-1435	100	2-1436	100	2-1437	100
125	12	32		-	-	-	-	2-4591	100	2-4592	100
125	10	32		2-2187	100	2-2188	100	2-2189	100	2-2190	100
125	12	32		-	-	-	-	2-4599	100	2-4600	100

Rueda PGAIB

Goma gris inyectada

90 kg - 100 kg



VENTAJAS DEL ARO

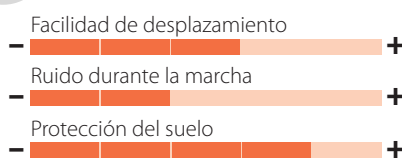

-20° a +60°

Más información en página 273

*** AMPLIAMOS GAMA**

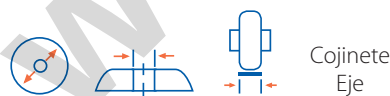

				Código	KG	Código	KG	Código	KG	Código	KG
100	10	32		2-4601	90	2-4602	90	2-4603	90	2-4604	90
100	12	32		-	-	-	-	2-4605	90	2-4606	90
125	10	32		2-2719	100	2-2720	100	2-2721	100	2-2722	100
125	12	32		-	-	-	-	2-4607	100	2-4608	100

Rueda PGZ

Goma gris inyectada

90 - 100 kg



VENTAJAS DEL ARO

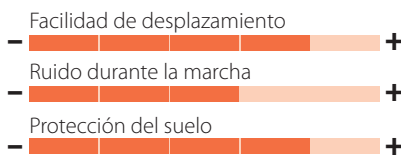

-25° a +80°

Más información en página 275

*** AMPLIAMOS GAMA**



Cojinete Eje

				Código	KG	*	Código	KG	*	Código	KG	*	Código	KG
100	10	30		2-4609	90	*	2-4610	90	*	2-4611	90	*	2-4612	90
100	12	30		-	-		-	-		2-4613	90	*	2-4614	90
100	10	30		2-4617	90	*	2-4618	90	*	2-4619	90	*	2-4620	90
100	12	30		-	-		-	-		2-4621	90	*	2-4622	90
125	10	32		2-3702	100		2-3703	100		2-3704	100		2-3705	100
125	12	32		-	-		-	-	*	2-4615	100	*	2-4616	100
125	10	32		2-4623	100	*	2-4624	100	*	2-4625	100	*	2-4626	100
125	12	32		-	-		-	-	*	2-4627	100	*	2-4628	100

Rueda PGC

Poliuretano gris conductivo

90 - 100 kg



VENTAJAS DEL ARO

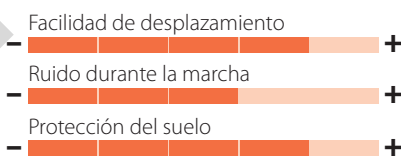

-25° a +80°

Más información en página 283



NOVEDAD



Cojinete Eje

				Código	KG		Código	KG		Código	KG		Código	KG
100	10	32		2-4727	90		2-4728	90		2-4729	90		2-4730	90
100	12	32		-	-		-	-		2-4731	90		2-4732	90
125	10	32		2-4733	100		2-4734	100		2-4735	100		2-4736	100
125	12	32		-	-		-	-		2-4737	100		2-4738	100

Rueda PPI

Poliuretano inyectado

90 kg - 100 kg



VENTAJAS DEL ARO

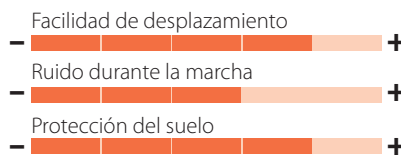

-20° a +80°

Más información en página 283

NOVEDAD



Cojinete Eje

100	10	32	—
100	12	32	—
125	10	32	—
125	12	32	—

Código	KG
2-4674	90
-	-
2-2463	100
-	-

Código	KG
2-4675	90
-	-
2-2466	100
-	-

Código	KG
2-4676	90
2-4678	90
2-2469	100
2-4772	100

Código	KG
2-4677	90
2-4679	90
2-2472	100
2-4773	100

Rueda UT

Poliamix blando

90 - 100 kg



VENTAJAS DEL ARO

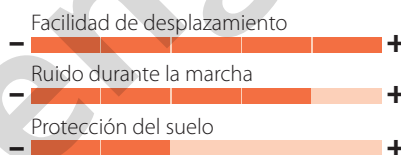

-20° a +60°

Más información en página 286

NOVEDAD

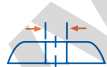

Cojinete Eje

100	10	34	—
100	12	34	—
100	10	34	▨
100	12	34	▨
125	10	35	—
125	12	35	—
125	10	35	▨
125	12	35	▨

Código	KG
2-4764	90
-	-
2-4796	90
-	-
2-1432	100
-	-
2-4802	100
-	-

Código	KG
2-4765	90
-	-
2-4797	90
-	-
2-1917	100
-	-
2-4803	100
-	-

Código	KG
2-4766	90
2-4768	90
2-4798	90
2-4800	90
2-1433	100
2-4770	100
2-4804	100
2-4806	100

Código	KG
2-4767	90
2-4769	90
2-4799	90
2-4801	90
2-1918	100
2-4771	100
2-4805	100
2-4807	100

SERIE HC

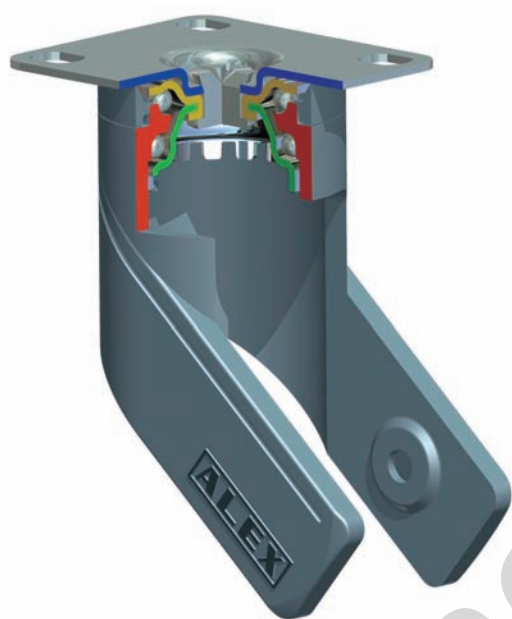

NOVEDAD

DETALLES DEL PRODUCTO

- ✓ Soporte fabricado en poliamida de alta calidad, endurecida en fibra de vidrio.
- ✓ Cabezal giratorio superior construido en:
 - Doble hilera de bolas endurecida (fijación placa y agujero pasante)
 - Cojinete de bolas de precisión insertado (fijación espiga roscada)
- ✓ Rueda de goma termoplástica gris inyectada.
- ✓ Especialmente diseñada para usos en: Mobiliario Clínico, Hostelería y Colectividades.

100 kg **125 mm**

» Fabricadas según normas europeas EN 12530

Disponible con bloqueo direccional. Convierte una rueda giratoria en fija.

Medidas Generales

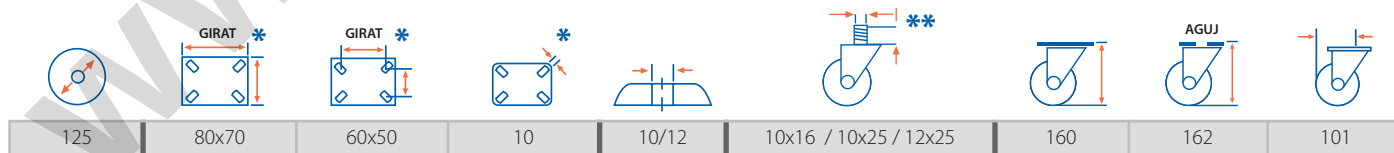

* Detalle de planos de platina, ver página 30

** Medidas disponibles en fijación espiga roscada

Rueda PGAIB

Goma termoplástica gris inyectada

100 kg

CABEZAL CON DOBLE HILERA DE BOLAS



VENTAJAS DEL ARO

- Facilidad de desplazamiento +
- Ruido durante la marcha +
- Protección del suelo +

Temperatura: -20° a +60°

Más información en página 273

NOVEDAD

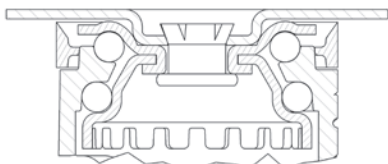

BLOQUEO DIRECCIONAL



Cojinete Eje

125	10	32	
-----	----	----	--

Código	KG
2-4641	100

Código	KG
2-4642	100

Código	KG
2-4990	100



BLOQUEO DIRECCIONAL

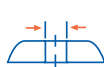

Cojinete Eje

125	10	32	
125	12	32	

Código	KG
2-4637	100
2-4639	100

Código	KG
2-4638	100
2-4640	100

Código	KG
2-4991	100
2-4992	100

COJINETE DE BOLAS DE PRECISIÓN

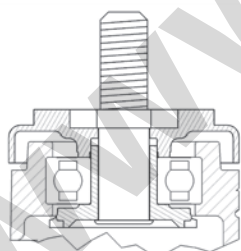

NOVEDAD



Cojinete Eje

125	32	M10x16	
125	32	M10x25	
125	32	M12x25	

Código	KG
2-4643	100
2-4645	100
2-4647	100

Código	KG
2-4644	100
2-4646	100
2-4648	100

NOVEDAD

DETALLES DEL PRODUCTO

- ✓ Carcasa fabricada con fibra de vidrio reforzada.
- ✓ Soporte pivotante de fácil encaje.
- ✓ Rueda doble de poliuretano.
- ✓ Cabezal giratorio con doble cojinete de bolas de precisión.
- ✓ Especialmente diseñadas para el sector hospitalario, clínico-sanitario.

125 kg

100 a 125 mm

- » Acabado en color gris RAL 7035
- » Fabricadas según normas europeas EN 12530
- » Shore 95° A

Medidas Generales



100	10/12	106	82
125	10/12	130	102

NOTA: casquillo reductor a 10 mm. Cód. 1-0115

NOTA: casquillo reductor a 12 mm. Cód. 1-0141

Rueda HD

Poliuretano

125 kg

VENTAJAS DEL ARO

- Facilidad de desplazamiento
- Ruido durante la marcha
- Protección del suelo

-25° a +80°

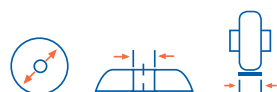
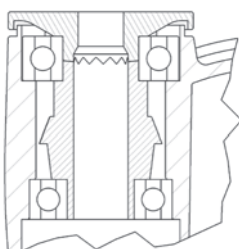

Cojinete
Eje

Diámetro	Alto	Carro	Cojinete
100	10	20x2	
100	12	20x2	
125	10	20x2	
125	12	20x2	



Código	KG	Código	KG
2-4986	125	2-4987	125
2-4687	125	2-4688	125
2-4988	125	2-4989	125
2-4689	125	2-4690	125

NOVEDAD

NOTA: casquillo reductor a 10 mm. Cód. 1-0115

NOTA: casquillo reductor a 12 mm. Cód. 1-0141

Modelos disponible en color Gris o Negro bajo pedido. Consultar.



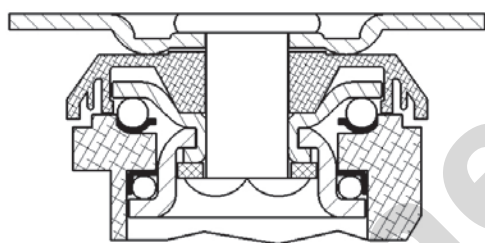

80 - 100 kg
100 a 125 mm

» Fabricadas según normas europeas EN 12530

DETALLES DEL PRODUCTO

- ✓ Soporte de fibra de nylon de gran dureza.
- ✓ Doble hilera de bolas endurecidas.
- ✓ Freno de doble acción: frena la rueda y la orientación de la horquilla.

Medidas Generales



100	67x77	62x52/55x46	8	12	141	135	88
125	67x77	62x52/55x46	8	12	168	162	100

* Detalle de planos de platina, ver página 30

Rueda Soporte AN

Poliuretano gris inyectado



80 - 100 kg



 -20° a +60°



Cojinete
Eje

100	32	
125	32	

Código



4-1554	80
4-1555	100

Código



4-1556	80
4-1557	100

Código



4-1602	80
4-1603	100

Código



4-1604	80
4-1605	100



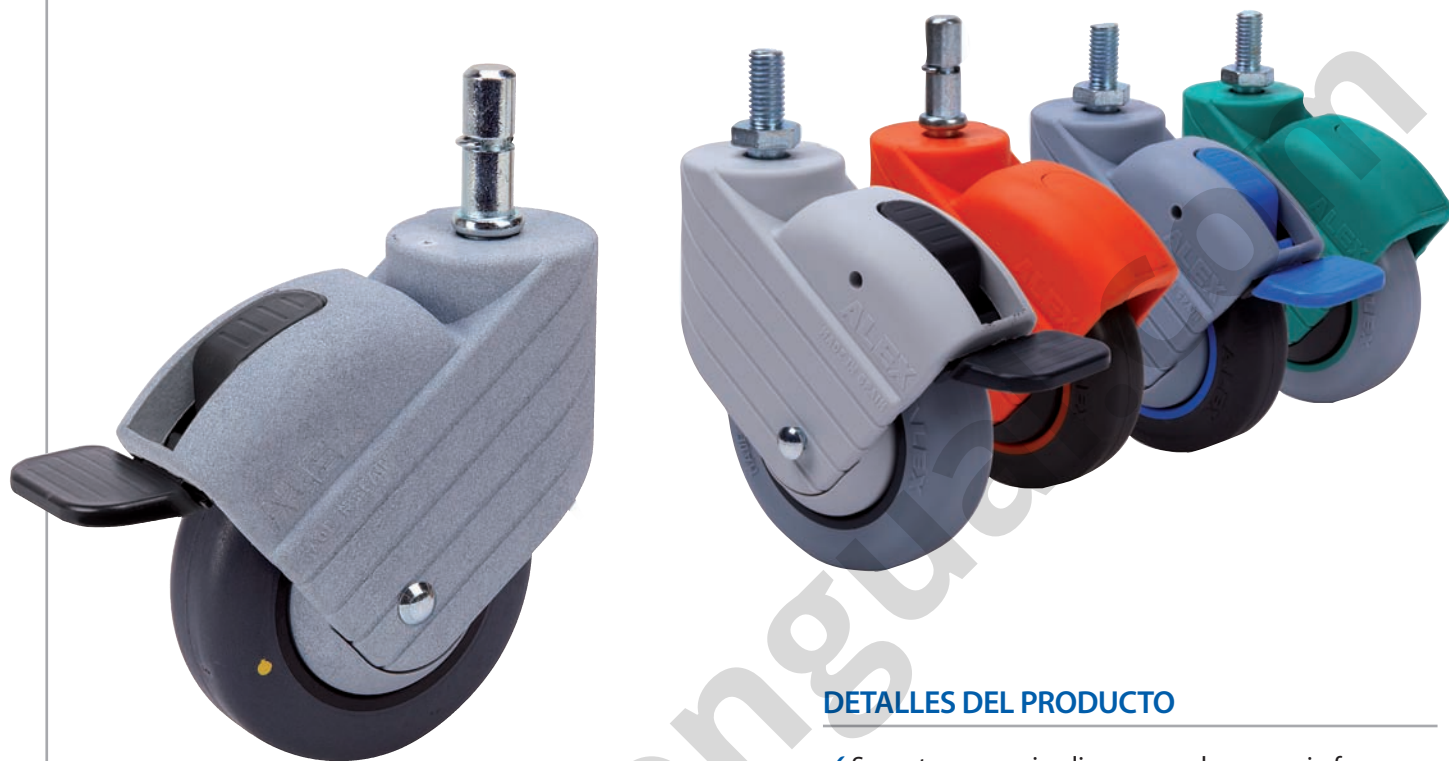

40 kg **80 a 100 mm**

- » Fabricada en poliamix reforzado.
- » Fabricadas según normas europeas EN 12528

DETALLES DEL PRODUCTO

- ✓ Soporte con espiga lisa o roscada, con y sin freno.
- ✓ Freno ergonómico redondeado con retorno integrado.
- ✓ Diseñadas para mobiliario, sector hospitalario y restauración.
- ✓ Color personalizado opcional.

Medidas Generales

80	-	-	-	-	10x20	11x30	114	72
100	-	-	-	-	10x20	11x30	132	90

Rueda PGI

Poliamix y goma gris

40 kg



VENTAJAS DEL ARO

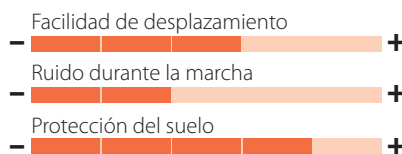

🌡️ -20° a +60°

Más información en página 273

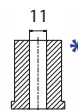
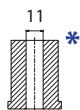

Cojinete Eje

80	24	—
100	25	—

Código



2-3319	40
2-3323	40

Código



2-3320	40
2-3324	40

Código



2-3321	40
2-3325	40

Código



2-3322	40
2-3326	40

*ver página 246

Rueda PGI

Poliamix y goma negra

40 kg



VENTAJAS DEL ARO

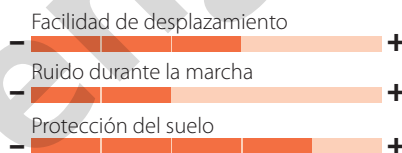

🌡️ -20° a +60°

Más información en página 273

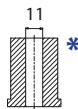
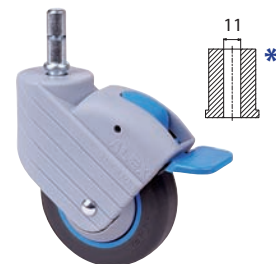
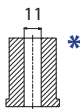

Cojinete Eje

80	24	—
100	25	—

Código



2-3206	40
2-3315	40

Código



2-3207	40
2-3316	40

Código



2-3208	40
2-3317	40

Código



2-3209	40
2-3318	40

*ver página 246

Rueda PGC

Conductiva

40 kg



VENTAJAS DEL ARO

- Facilidad de desplazamiento +
- Ruido durante la marcha +
- Protección del suelo +

-20° a +60°

Más información en página 283

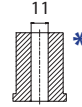
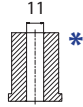

Cojinete
Eje

80	24	—
100	25	—

Código



2-3570	40
2-3573	40

Código



2-3571	40
2-3574	40

Código



2-3569	40
2-3575	40

Código



2-3572	40
2-3576	40

*ver página 246



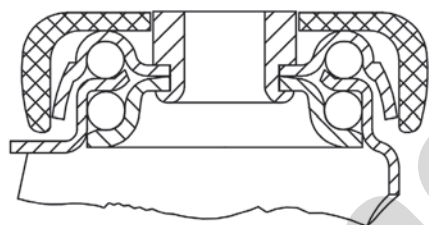

DETALLES DEL PRODUCTO

SERIE M

- ✓ Especialmente diseñada para: Carros de supermercado de trabajo duro.
- ✓ Protecciones antihilos.
- ✓ Se pueden suministrar con espigas especiales, previa consulta de cantidades mínimas.
- ✓ Especialmente diseñada para: Carros de supermercado en rampas mecánicas.

50 - 90 kg **80 a 125 mm**

- » Acabado cincado
- » Fabricadas según normas europeas EN 12530

Medidas Generales



80	GIRAT	FIJA	GIRAT	AGUJ	80	100	125
-	-	-	-	10	-	102	74
-	-	-	-	12	-	131	87
-	-	-	-	12	-	154	105

Rueda PGAIB

Goma gris inyectada

50 - 90 kg



VENTAJAS DEL ARO

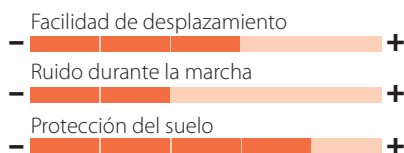

-20° a +60°

Más información en página 273

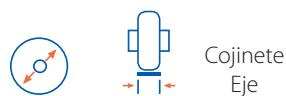

80	24	
100	32	
100	32	
125	32	



Código	KG
2-0326	50
2-0295	85
2-1136	85
2-1137	90



Código	KG
-	-
-	-
2-3503	85
2-3504	90



Código	KG
2-0806	60
2-0784	110
2-2759	85
2-1146	90

Rueda PU

Poliuretano inyectado

85 - 90 kg



VENTAJAS DEL ARO

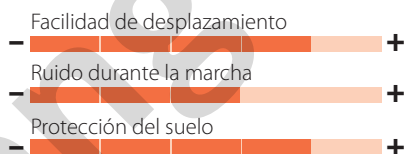

-25° a +80°

Más información en página 283



100	32	
125	32	



Código	KG
2-1044	85
2-1038	90



Código	KG
2-3505	85
2-3506	90



Código	KG
2-1100	100
2-1037	175

Rueda MEB

Poliuretano inyectado

80 kg



Rampa Mecánica



Rampa Mecánica

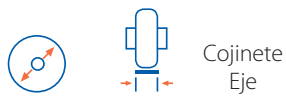

125	30	
-----	----	--

Código	KG	KG
2-3137	80	40

Código	KG	KG
2-3507	80	40

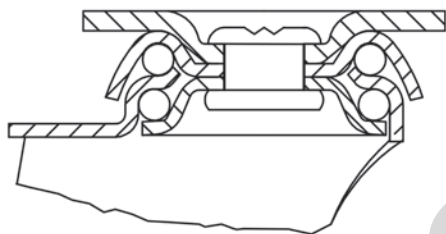

DETALLES DEL PRODUCTO

- ✓ Fabricado con chapa de acero hasta 2 m/m de espesor.
- ✓ Soporte con doble rodamiento a bolas.
- ✓ Especialmente diseñada para: Usos de hostelería, hospitalarios, expositores, mostradores, y decoración.

KG 40 - 80 kg 60 a 100 mm

- » Acabado cincado brillante
- » Fabricadas según normas europeas EN 12538/12530

Medidas Generales

60	70x55	-	54x38	6	10	88	85	62
80	70x55	75x66	54x38	6	10	112	108	77
100	70x55	75x66	54x38	6	10	134	130	90

* Detalle de planos de platina, ver página 30

Medidas Especiales

60	-	-	-	-	40x40	12x30	87	62
80	-	-	-	-	40x40	12x30	108	77

Rueda PGI

Goma gris inyectada

40 - 70 kg



VENTAJAS DEL ARO

- Facilidad de desplazamiento
- Ruido durante la marcha
- Protección del suelo

-20° a +60°

Más información en página 273



Cojinete
Eje

60	22	---
80	24	---
100	25	---

Código



1-0163	40
1-0180	60
3-0004	70

*

Código



2-4337	40
2-2459	60
2-2460	70

*

Código



2-4480	40
1-0386	60
1-0302	70

Código



2-1064	40
2-0806	60
2-0787	70

40 - 70 kg



Cojinete
Eje

60	22	---
80	24	---
100	25	---

Código



1-0170	40
1-0179	60
3-0008	70

*

Código



2-4481	40
1-0387	60
1-0303	70

*

Código



1-0176	40
1-0294	50
-	-

*

Código



2-4635	40
1-0388	50
-	-

40 - 50 kg



*ver página 246



Cojinete
Eje

60	22	---
80	24	---
100	25	---

Código



2-1489	40
2-1491	50
-	-

*

Código



2-4636	40
2-1492	50
-	-

Código



2-1064	40
2-0806	60
2-0787	70

Rueda PGI B

Goma gris inyectada

70 - 80 kg



VENTAJAS DEL ARO

- Facilidad de desplazamiento +
- Ruido durante la marcha +
- Protección del suelo +

-20° a +60°

Más información en página 273



Cojinete Eje

80	25	
100	25	

Código



2-2810	70
2-2815	80

Código



2-2814	70
2-2819	80

Código



2-2812	70
2-2817	80

Código



2-2891	70
2-2892	80

70 - 80 kg



Cojinete Eje

80	25	
100	25	

Código



2-2811	70
2-2816	80

Código



2-2813	70
2-2818	80

Código



2-2891	70
2-2892	80

Rueda PPI

Poliuretano inyectado

50 - 80 kg



VENTAJAS DEL ARO

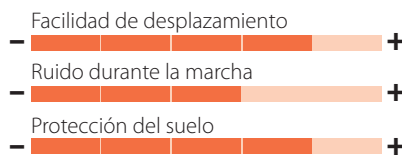

-25° a +80°

Más información en página 283



Cojinete Eje

60	22	---
80	24	---
100	25	---

Código



2-2522	50
2-2461	70
2-2462	80

*

Código



2-4338	50
2-2473	70
2-2474	80

*

Código



2-4476	50
2-2464	70
2-2465	80

Código



2-2521	60
2-2477	80
2-2475	100

50 - 80 kg



Cojinete Eje

60	22	---
80	24	---
100	25	---

Código



2-2525	50
2-2467	70
2-2468	80

*

Código



2-4477	50
2-2470	70
2-2471	80

Código



2-2521	60
2-2477	80
2-2475	100

Rueda BP

Poliamix blanco

50 - 80 kg



VENTAJAS DEL ARO

- Facilidad de desplazamiento
- Ruido durante la marcha
- Protección del suelo

-20° a +60°

Más información en página 290



Cojinete
Eje

60	24	---
80	24	---
100	25	---

Código



KG

1-0166	50
2-1911	70
1-0221	80

*

Código



KG

1-0181	50
2-2457	70
2-2458	80

*

Código



KG

2-4478	50
2-1912	70
2-1915	80

Código



KG

1-0318	60
2-1926	70
4-0021	80

50 - 80 kg



Cojinete
Eje

60	24	---
80	24	---
100	25	---

Código



KG

1-0174	50
2-1913	70
1-0222	80

*

Código



KG

2-4479	50
2-1914	70
2-1916	80

*

Código



KG

1-0177	50
2-1919	70
-	-

*

Código



KG

2-4633	50
2-1920	70
-	-

50 - 70 kg



*ver página 246



Cojinete
Eje

60	24	---
80	24	---

Código



KG

2-1488	50
2-1921	70

*

Código



KG

2-4634	50
2-1922	70

Código



KG

1-0318	60
2-1926	70

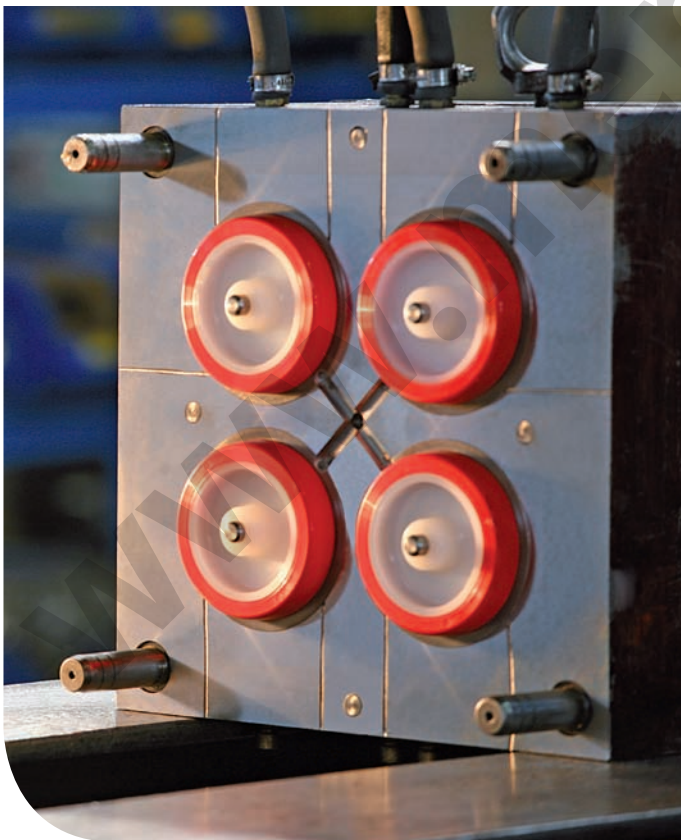

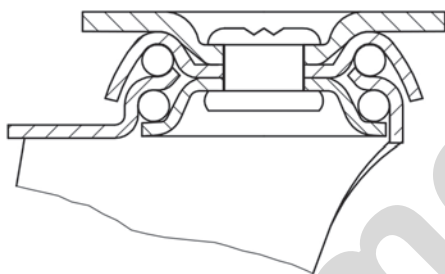
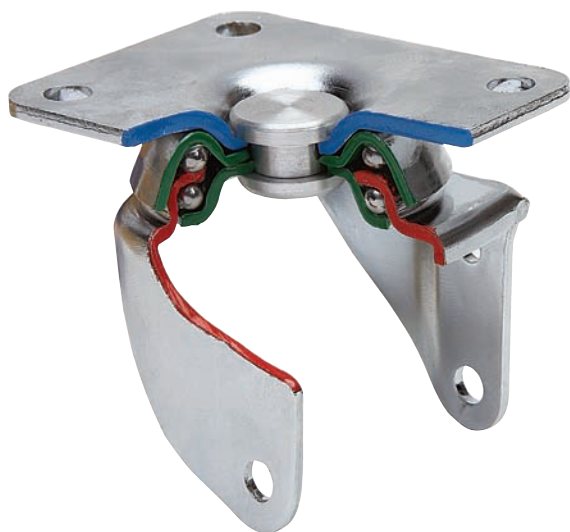

DETALLES DEL PRODUCTO

- ✓ Fabricada con chapa de acero hasta 2,5 m/m de espesor.
- ✓ Soporte con doble rodamiento a bolas.
- ✓ Acabado cincado muy brillante.
- ✓ Especialmente diseñado para: Mobiliario clínico, cámaras frigoríficas, mostradores, máquinas asadoras de pollos...

75 - 100 kg	75 mm
-------------	-------

» Fabricadas según normas europeas EN 12528

Medidas Generales

75	GIRAT* 77x67	FIJA* -	GIRAT* 62x52/50x42	8	10	101	AGUJ 99	74

* Detalle de planos de platina, ver página 31

Goma gris inyectada
75 kg

-20 a +60°



		Cojinete Eje
75	24x2	—

Código **1-0499** 75

Código **1-0500** 75

Código **1-0501** 75

Código **1-0502** 75

Poliamix negra
100 kg

-20 a +60°



		Cojinete Eje
75	24x2	—

Código **1-0649** 100

Código **1-0650** 100

Código **1-0651** 100

Código **1-0652** 100

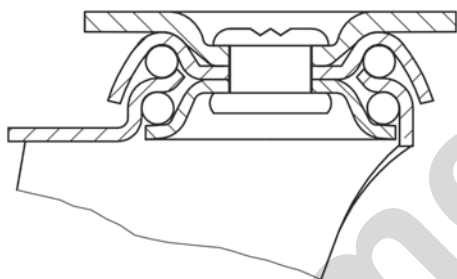

DETALLES DEL PRODUCTO

- ✓ Fabricado con chapa de acero hasta 2 m/m de espesor.
- ✓ Soporte con doble rodamiento a bolas.
- ✓ Acabado cincado muy brillante.
- ✓ Especialmente diseñado para: Cámaras frigoríficas, mostradores, máquinas asadoras de pollos...











70 - 100 kg



50 mm

» Fabricadas según normas europeas EN 12528

Medidas Generales

								
50	70x55	-	54x38	6	10/12	78	74	41

* Detalle de planos de platina, ver página 31

Rueda PGI

Goma gris

70 kg



VENTAJAS DEL ARO

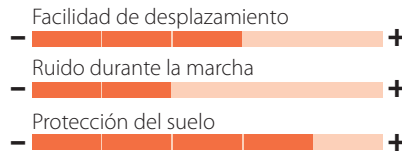

🌡️ -25° a +60°

Más información en página 273

*** AMPLIAMOS GAMA**

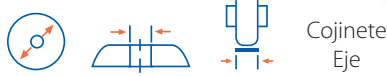

Cojinete Eje

50	10	18x2	—
50	12	18x2	—

Código	KG
1-0395	70
-	-

Código	KG
1-0396	70
-	-

Código	KG
1-0397	70
* 1-0569	70

Código	KG
1-0398	70
* 1-0570	70

Rueda PPI

Poliuretano inyectado

100 kg



VENTAJAS DEL ARO

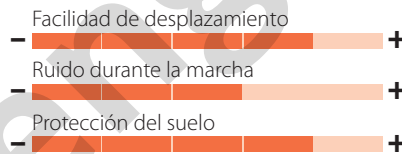

🌡️ -25° a +60°

Más información en página 283

NOVEDAD



Cojinete Eje

50	10	18x2	—
50	12	18x2	—

Código	KG
1-0790	100
-	-

Código	KG
1-0791	100
-	-

Código	KG
1-0792	100
1-0794	100

Código	KG
1-0793	100
1-0795	100

Rueda BP

Polipropileno

90 kg



VENTAJAS DEL ARO

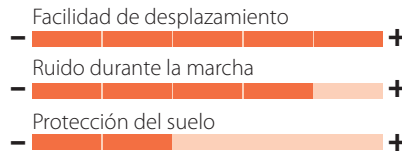

🌡️ -25° a +60°

Más información en página 290

* **AMPLIAMOS GAMA**

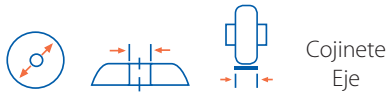

50	10	18x2	Cojinete Eje
50	12	18x2	---

Código	KG	Código	KG	Código	KG	Código	KG
2-0039	90	1-0390	90	2-0040	90	1-0391	90
-	-	-	-	* 1-0567	90	* 1-0568	90

A los soportes de agujero pasante se les puede aplicar espigas especiales y fijaciones expansivas.

Para hacer el pedido, añadir el "código" de la rueda deseada. Por ejemplo: 2-1133 más expansivo 2-2182.

Con fijaciones expansivas de plástico

Redondo



Código

2-2181	19/21
2-2182	22/24
2-2183	25/29



Cuadrado



Código

2-2185	22/24
2-2186	25/29
2-3502	37/39
2-2789	40/42



Tacos amortiguadores flexibles

Redondo



Código

Código	94	22
2-2202	94	22
2-2205	94	25
2-2203	94	32

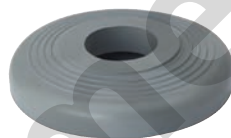

Cuadrado



Código

Código	94	22
2-2204	94	22
2-2201	94	24
2-2207	94	25
2-2206	94	32



Protector cojinete SERIE M

Código



Color

2-2234	100	gris
2-2790	100	rojo
2-2771	125	gris
2-2791	125	rojo

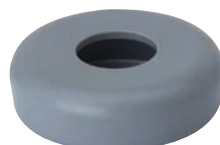



Ruedas para

muebles auxiliares

decoración, expositores,
electrodomésticos, etc.

Hasta 120 kg por rueda

ÍNDICE

* AMPLIAMOS GAMA	• Serie HP	pág. 218
	• Serie IB	pág. 222
	• Serie BD	pág. 224
	• Serie B	pág. 230
	• Serie H	pág. 234
	• Serie Z	pág. 236
	• Serie N	pág. 238
* AMPLIAMOS GAMA	• Serie DK	pág. 242
	• Serie DKG	pág. 245
	• Fixalenes	pág. 246





22 - 30 kg	50 mm
------------	-------

- » Fabricado en poliamix reforzado.
- » Fabricadas según normas europeas EN 12528

DETALLES DEL PRODUCTO

- ✓ Soporte con placa y espiga roscada, con y sin freno.
- ✓ Freno ergonómico redondeado con retorno integrado.
- ✓ Diseñadas especialmente para el sector mobiliario y restauración.
- ✓ Color personalizado opcional.

Medidas Generales

50	GIRAT* 42x42	FIJA* -	GIRAT* 32x32	FIJA* -	ESP. ROSCADA M8x15	80	84	52

* Detalle de planos de platina, ver página 32

Rueda PGI

Poliamix y goma gris

22 kg



VENTAJAS DEL ARO

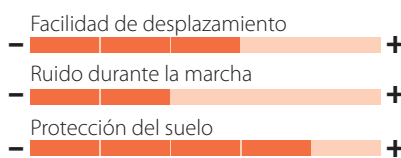

🌡️ -20° a +60°

Más información en página 273



Cojinete Eje

50

18



Código



1-0756

22



Código



1-0760

22



Código



1-0764

22



Código



1-0768

22

22 kg

NOVEDAD



Cojinete Eje

50

18



Código



1-0785

22



Código



1-0786

22

Rueda PGI

Poliamix negro y goma gris

22 kg



VENTAJAS DEL ARO

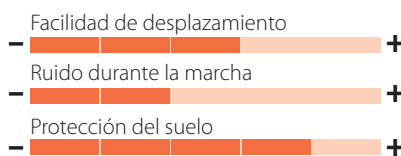

🌡️ -20° a +60°

Más información en página 273



Cojinete Eje

50

18



Código



1-0757

22



Código



1-0761

22



Código



1-0765

22



Código



1-0769

22

Rueda PPI

Poliuretano inyectado

30 kg



VENTAJAS DEL ARO

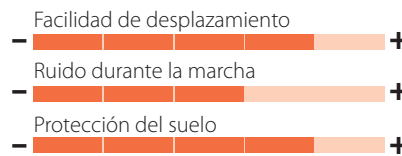

🌡️ -20° a +60°

Más información en página 283



Cojinete Eje

50

18

Código



1-0758

30

Código



1-0762

30

Código



1-0766

30

Código



1-0770

30

Rueda PUA

Poliuretano inyectado blando

30 kg



VENTAJAS DEL ARO

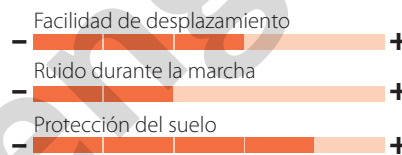

🌡️ -20° a +60°

Más información en página 282



Cojinete Eje

50

18

Código



1-0759

30

Código



1-0763

30

Código



1-0767

30

Código



1-0771

30



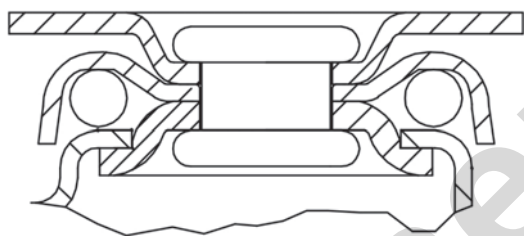

30 - 50 kg **40 a 50 mm**

- » Acabado cincado
- » Fabricadas según normas europeas EN 12528

DETALLES DEL PRODUCTO

- ✓ Soporte embutido de chapa de acero hasta 3 m/m de espesor.
- ✓ Doble rueda o rodillo de poliamix color gris para moquetas.
- ✓ Diseñadas especialmente para: Moquetas, frigoríficos, expositores, mesas taller, mobiliario...

Medidas Generales

40	70x55	-	54x38	6	10	65	62	40
50	70x55	-	54x38	6	10	70	73	41

* Detalle de planos de platina, ver página 32

Serie IB



Rueda BP

Polipropileno gris
40 - 50 kg

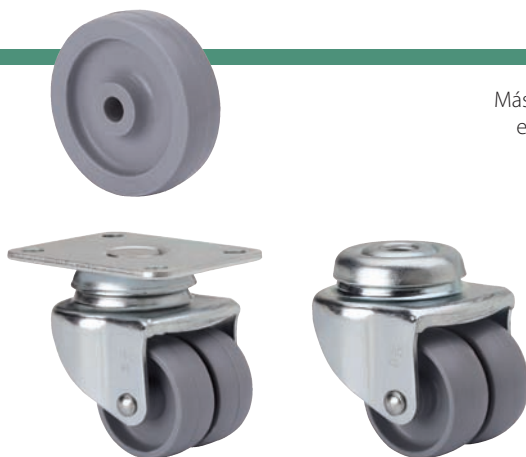

Más información en página 290

VENTAJAS DEL ARO

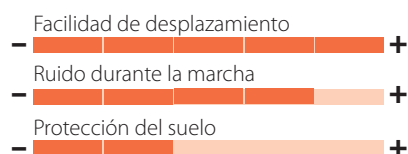

-20° a +60°



Cojinete
Eje

40	17x2	—
50	17x2	—

Código



3-0012	40
-	-

Código



3-0014	40
1-0274	50

Código



1-0308	30
1-0439	40

Rueda PGI

Goma gris inyectada
30 kg



Más información en página 273

VENTAJAS DEL ARO

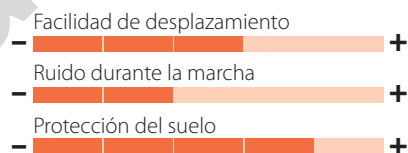

-20° a +60°



Cojinete
Eje

40	16x2	—
----	------	---

Código



1-0265	30
--------	----

Código



1-0021	30
--------	----

Código



1-0319	17
--------	----

Rueda KP

Poliamix blanco
45 kg



Más información en página 291

VENTAJAS DEL ARO

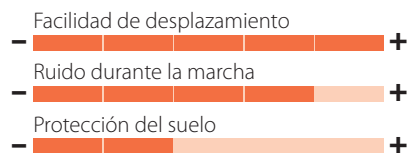

-20° a +60°



Cojinete
Eje

40	35	—
----	----	---

Código



1-0262	45
--------	----

Código



1-0273	45
--------	----

Código



1-0314	45
--------	----

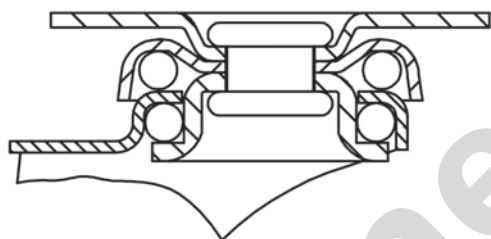

KG 15 - 40 kg **30 a 60 mm**

- » Acabado niquelado brillante
- » Fabricadas según normas europeas EN 12528

DETALLES DEL PRODUCTO

- ✓ Fabricada con chapa de acero embutida hasta 2 m/m de espesor.
- ✓ Ruedas de goma de 30, 40, 50 y 60 de diámetro con protectores incluidos de serie.
- ✓ Especialmente diseñada para pequeños muebles, expositores, displays, etc.

Medidas Generales

	GIRAT *	FIJA *						AGUJ		
30	46x36	34x24	5	8	-	-	51	48	-	40
40	46x36	34x24	5	8	38x38	-	58	57	-	50
50	70x55	54x38	6	10	-	12x29	72	67	96	55
60	70x55	54x38	6	10	38x38	12x29	81	78	107	60

* Detalle de planos de platina, ver página 32

Rueda PGI

Goma gris inyectada

15 - 25 kg



VENTAJAS DEL ARO

- Facilidad de desplazamiento +
- Ruido durante la marcha +
- Protección del suelo +

-20° a +60°

Más información en página 273



Cojinete Eje

30	16	---
40	16	---
50	18	---
60	18	---

Código



1-0700	15
1-0701	17
1-0702	22
1-0703	25

Código



-	-
1-0708	17
1-0709	22
1-0710	25

Código



1-0324	15
1-0468	17
1-0399	30
1-0321	35

15 - 25 kg



Cojinete Eje

30	16	---
40	16	---
50	18	---
60	18	---

Código



1-0704	15
1-0705	17
1-0706	22
1-0707	25

Código



-	-
1-0711	17
1-0712	22
1-0713	25

Código



1-0324	15
1-0468	17
1-0399	30
1-0321	35

Rueda PPI

Poliuretano inyectado

15-40 kg



VENTAJAS DEL ARO

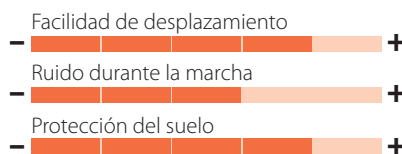

-25° a +80°

Más información en página 283



Cojinete Eje

30	16	---
40	16	---
50	18	---
60	18	---

Código



1-0742	15
1-0743	22
1-0744	35
1-0745	40

Código



-	-
1-0750	22
1-0751	35
1-0752	40

Código



2-2558	15
2-2559	25
2-2560	40
2-2561	60

15 - 40 kg



Cojinete Eje

30	16	---
40	16	---
50	18	---
60	18	---

Código



1-0746	15
1-0747	22
1-0748	35
1-0749	40

Código



-	-
1-0753	22
1-0754	35
1-0755	40

Código



2-2558	15
2-2559	25
2-2560	40
2-2561	60

Rueda PUA

Poliuretano inyectado blando

15-40 kg



VENTAJAS DEL ARO

- Facilidad de desplazamiento +
- Ruido durante la marcha +
- Protección del suelo +

-25° a +80°

Más información en página 282



Cojinete Eje

30	16	—
40	16	—
50	18	—
60	18	—

Código



1-0728	15
1-0729	22
1-0730	35
1-0731	40

Código



—	—
1-0736	22
1-0737	35
1-0738	40

Código



2-3508	15
2-3509	25
2-3510	40
2-3511	60

15 - 40 kg



Cojinete Eje

30	16	—
40	16	—
50	18	—
60	18	—

Código



1-0732	15
1-0733	22
1-0734	35
1-0735	40

Código



—	—
1-0739	22
1-0740	35
1-0741	40

Código



2-3508	15
2-3509	25
2-3510	40
2-3511	60

Rueda BP

Polipropileno gris

22-40 kg



VENTAJAS DEL ARO

- Facilidad de desplazamiento
- Ruido durante la marcha
- Protección del suelo

-20° a +60°

Más información en página 290



Cojinete Eje

40	17	—
50	17	—
60	17	—

Código



1-0715	22
1-0716	35
1-0717	40

Código



1-0722	22
1-0723	35
1-0724	40

Código



1-0415	30
1-0439	40
1-0310	45

22 - 40 kg



Cojinete Eje

40	17	—
50	17	—
60	17	—

Código



1-0719	22
1-0720	35
1-0721	40

Código



1-0725	22
1-0726	35
1-0727	40

Código



1-0415	30
1-0439	40
1-0310	45

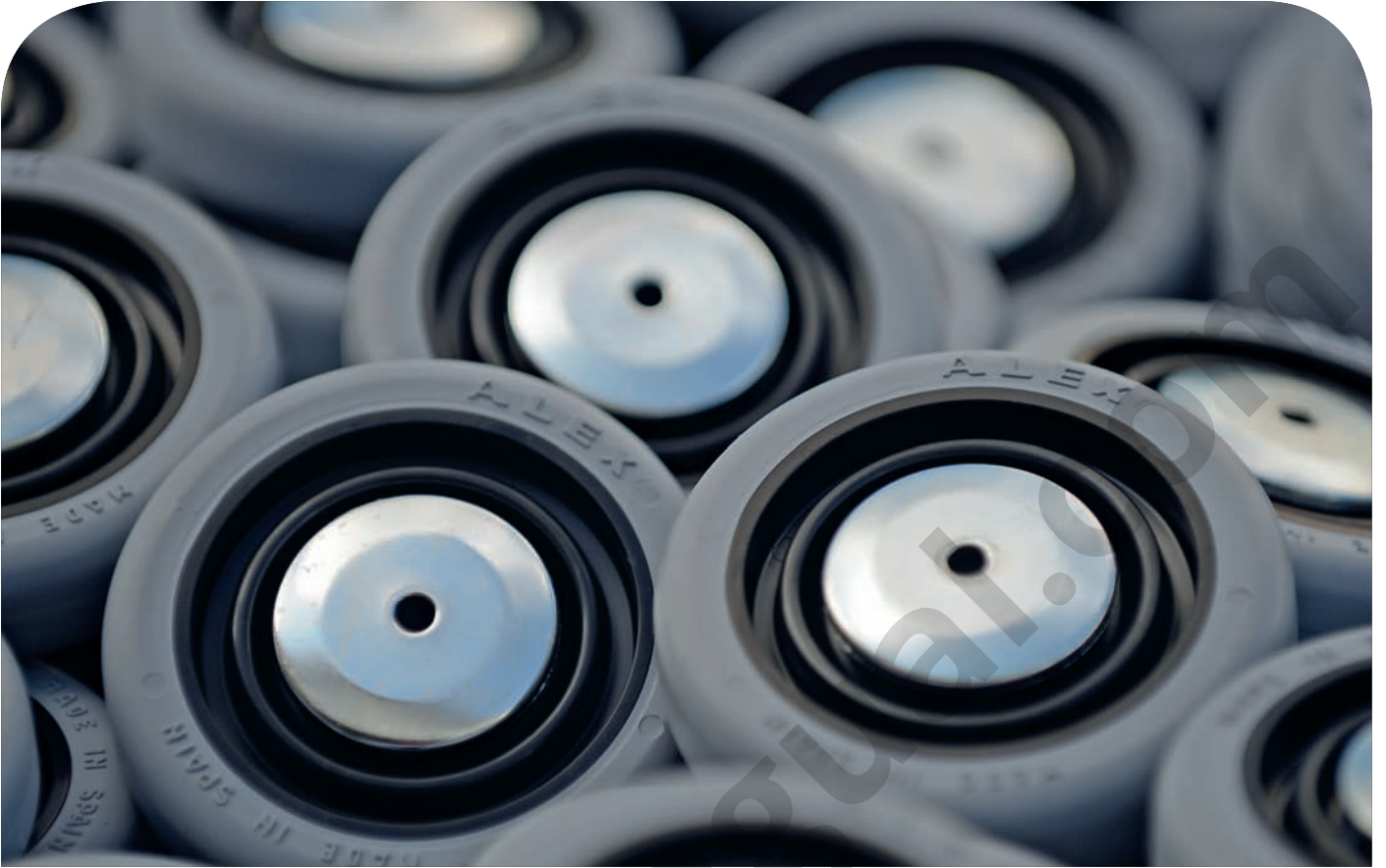

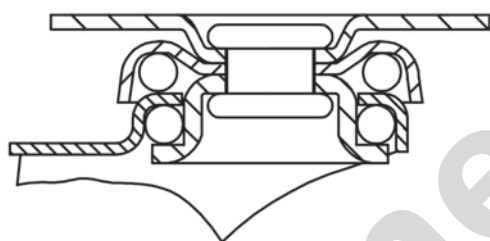

KG 15 - 40 kg **30 a 60 mm**

- » Acabado cincado brillante
- » Fabricadas según normas europeas EN 12528

DETALLES DEL PRODUCTO

- ✓ Fabricada con chapa de acero embutida hasta 2 m/m de espesor.
- ✓ Soporte con rodamiento a bolas.
- ✓ Ruedas de goma de 50 y 60 de diámetro con protectores incluidos de serie.
- ✓ Especialmente diseñadas para: Mesas de noche, Carros de limpieza, Stands, Equipamiento deportivo, Mesas de ordenador, Pequeño mobiliario.

Medidas Generales

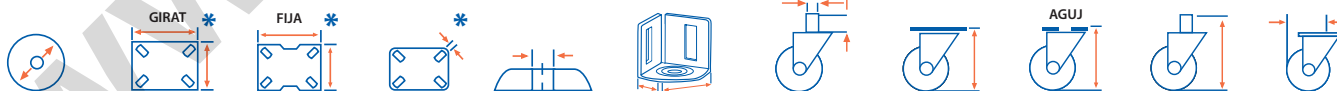

30	46x36	34x24	5	8	-	-	51	48	-	32
40	46x36	34x24	5	8	38x38	-	58	57	-	45
50	70x55	54x38	6	10	-	12x29	72	67	96	46
60	70x55	54x38	6	10	38x38	12x29	81	78	107	53

* Detalle de planos de platina, ver página 32

Serie B

Rueda PGI

Goma gris inyectada

15-25 kg



VENTAJAS DEL ARO

- Facilidad de desplazamiento +
- Ruido durante la marcha +
- Protección del suelo +

🌡️ -20° a +60°

Más información en página 273



Cojinete Eje

30	16	—
40	16	—
50	18	—
60	18	—

Código	KG
1-0214	15
1-0216	17
1-0217	22
1-0190	25

Código	KG
-	-
1-0547	17
1-0548	22
1-0549	25

Código	KG
-	-
-	-
-	-
1-0400	25

Código	KG
1-0324	15
1-0468	17
1-0399	30
1-0321	35

15 - 25 kg



Cojinete Eje

30	16	—
40	16	—
50	18	—
60	18	—

Código	KG
1-0215	15
1-0014	17
1-0218	22
1-0017	25

Código	KG
-	-
1-0550	17
1-0551	22
1-0552	25

Código	KG
-	-
-	-
-	-
1-0330	25

Código	KG
1-0324	15
1-0468	17
1-0399	30
1-0321	35

17 - 25 kg

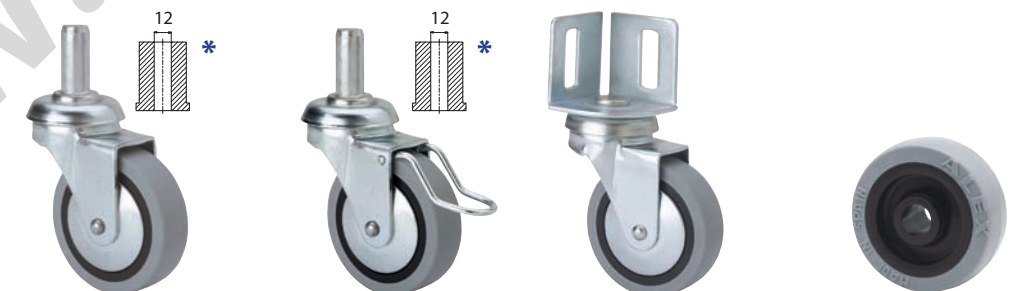

Cojinete Eje

30	16	—
40	16	—
50	18	—
60	18	—

Código	KG
-	-
-	-
1-0298	22
1-0178	25

Código	KG
-	-
-	-
-	-
1-0503	25

Código	KG
-	-
1-0223	17
-	-
1-0231	25

Código	KG
-	-
1-0468	17
1-0399	30
1-0321	35

*ver página 246

Serie B

Rueda PPI

Poliuretano inyectado

15-40 kg



VENTAJAS DEL ARO

- Facilidad de desplazamiento +
- Ruido durante la marcha +
- Protección del suelo +

-25° a +80°

Más información en página 283



Cojinete Eje

30	16	—
40	16	—
50	18	—
60	18	—

Código



2-2563	15
2-2564	22
2-2565	35
2-2566	40

Código



-	-
1-0553	22
1-0554	35
1-0555	40

Código



-	-
-	-
-	-
2-2569	40

Código



2-2558	15
2-2559	25
2-2560	40
2-2561	60

15 - 40 kg



Cojinete Eje

30	16	—
40	16	—
50	18	—
60	18	—

Código



2-2570	15
2-2571	22
2-2572	35
2-2573	40

Código



-	-
1-0556	22
1-0557	35
1-0558	40

Código



-	-
-	-
-	-
2-2576	40

Código



2-2558	15
2-2559	25
2-2560	40
2-2561	60

Serie B

Rueda BP

Polipropileno gris

15-40 kg

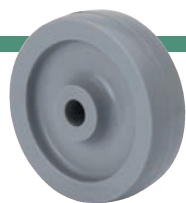

VENTAJAS DEL ARO

- Facilidad de desplazamiento +
- Ruido durante la marcha +
- Protección del suelo +

-20° a +60°

Más información en página 290



Cojinete Eje

30	16	—
40	17	—
50	17	—
60	17	—

Código	KG
1-0171	15
3-0001	22
1-0173	35
3-0003	40

Código	KG
-	-
1-0541	22
1-0542	35
1-0543	40

Código	KG
-	-
-	-
-	-
2-1494	40

Código	KG
1-0416	20
1-0415	30
1-0439	40
1-0310	45

15 - 40 kg



Cojinete Eje

30	16	—
40	17	—
50	17	—
60	17	—

Código	KG
3-0005	15
3-0006	22
1-0172	35
3-0007	40

Código	KG
-	-
1-0544	22
1-0545	35
1-0546	40

Código	KG
-	-
-	-
-	-
2-1495	40

Código	KG
1-0416	20
1-0415	30
1-0439	40
1-0310	45

22 - 40 kg

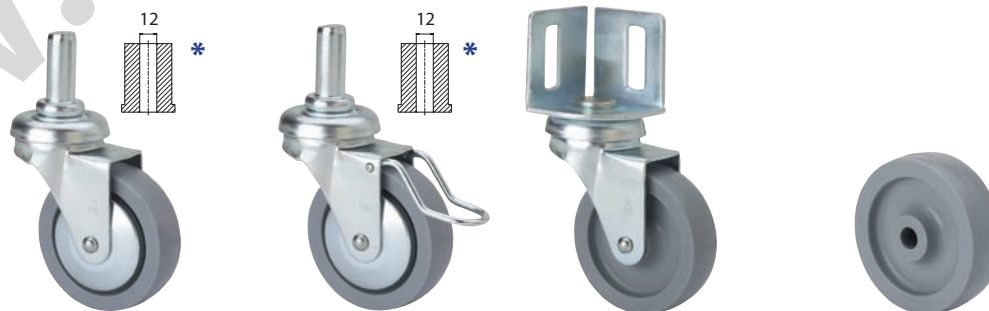

Cojinete Eje

30	16	—
40	17	—
50	17	—
60	17	—

Código	KG
-	-
-	-
1-0225	35
1-0228	40

Código	KG
-	-
-	-
-	-
1-0504	40

Código	KG
-	-
3-0009	22
-	-
3-0010	40

Código	KG
-	-
1-0415	30
1-0439	40
1-0310	45

*ver página 246



10 - 22 kg



25 a 40 mm



- ✓ Fabricada con chapa de acero embutida hasta 2 m/m de espesor.
- ✓ Especialmente diseñadas para: sector mobiliario y restauración

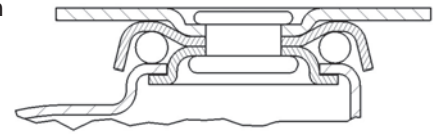

Medidas Generales

	GIRAT *	FIJA *	*	*	*	*	AGUJ	*
25	50x33	38x20	5	6	-	40	37	33
30	46x36	34x24	5	8	10x33	49	48	33
40	46x36	34x24	5	8	10x33	57	54	43

* Detalle de planos de platina, ver página 33

Rueda PGI

Goma gris inyectada

15-17 kg

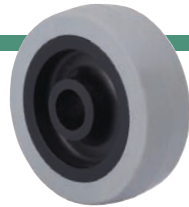

VENTAJAS DEL ARO

- Facilidad de desplazamiento
- Ruido durante la marcha
- Protección del suelo

-20° a +60°

Más información en página 273

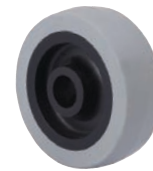

		Cojinete Eje
30	16	—
40	16	—

Código	
1-0278	15
1-0280	17

Código	
1-0023	15
1-0024	17

Código	
1-0324	15
1-0468	17

15 - 17 kg

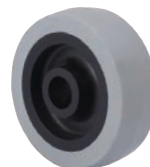

		Cojinete Eje
30	16	—
40	16	—

Código	
1-0288	15
1-0290	17

Código	
1-0324	15
1-0468	17

Serie H



Rueda BP

Polipropileno gris

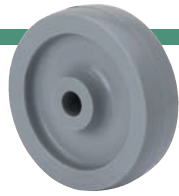
10-22 kg



VENTAJAS DEL ARO

- Facilidad de desplazamiento  +
- Ruido durante la marcha  +
- Protección del suelo  +

 -20° a +60°

Más información en página 290



25	11	—
30	15	—
40	17	—

Código 

1-0238	10
3-0016	15
3-0017	22

Código 

1-0237	10
3-0019	15
3-0020	22

Código 

-	-
1-0416	20
1-0415	30

15 - 22 kg

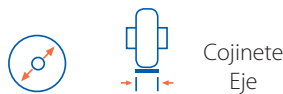

30	15	—
40	17	—

Código 

3-0021	15
3-0022	22

Código 

1-0416	20
1-0415	30

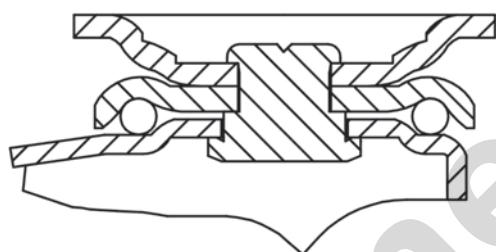

25 - 60 kg 35 a 60 mm

- » Acabado cincado brillante
- » Fabricadas según normas europeas EN 12528

DETALLES DEL PRODUCTO

- ✓ Soporte embutido con chapa de acero hasta 2 m/m de espesor.
- ✓ Diseñadas especialmente para pequeños muebles, expositores, displays, equipos de sonido, etc.

Medidas Generales

	GIRAT *	FIJA *	GIRAT *	FIJA *	GIRAT *	FIJA *		
35	47x47	-	35x30	-	6	-	49	36
40	51x51	51x45	37x37	37x26	6	6	54	40
60	70x55	52x57	55x42	42x26	8	6	84	59

* Detalle de planos de platina, ver página 33

Rueda PGI

Goma gris inyectada

25 - 40 kg



VENTAJAS DEL ARO

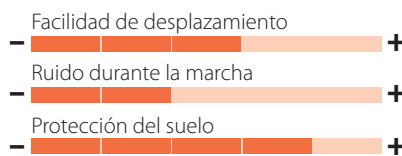

🌡️ -20° a +60°

Más información en página 273



Cojinete
Eje

40	17	—
60	24	—

Código



2-1576	25
2-1034	40

Código



2-1577	25
2-1035	40

Código



1-0319	25
2-1064	40

Rueda BP

Polipropileno

25 - 60 kg



VENTAJAS DEL ARO

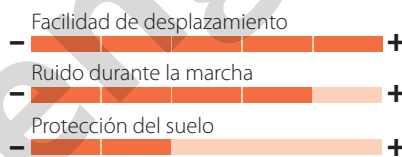

🌡️ -20° a +60°

Más información en página 290



Cojinete
Eje

35	18	—
40	17	—
60	24	—

Código



2-0041	30
2-0042	60

Código



2-0045	30
2-0046	60

Código



2-1575	25
-	-
-	-

Código



1-0414	30
1-0318	60

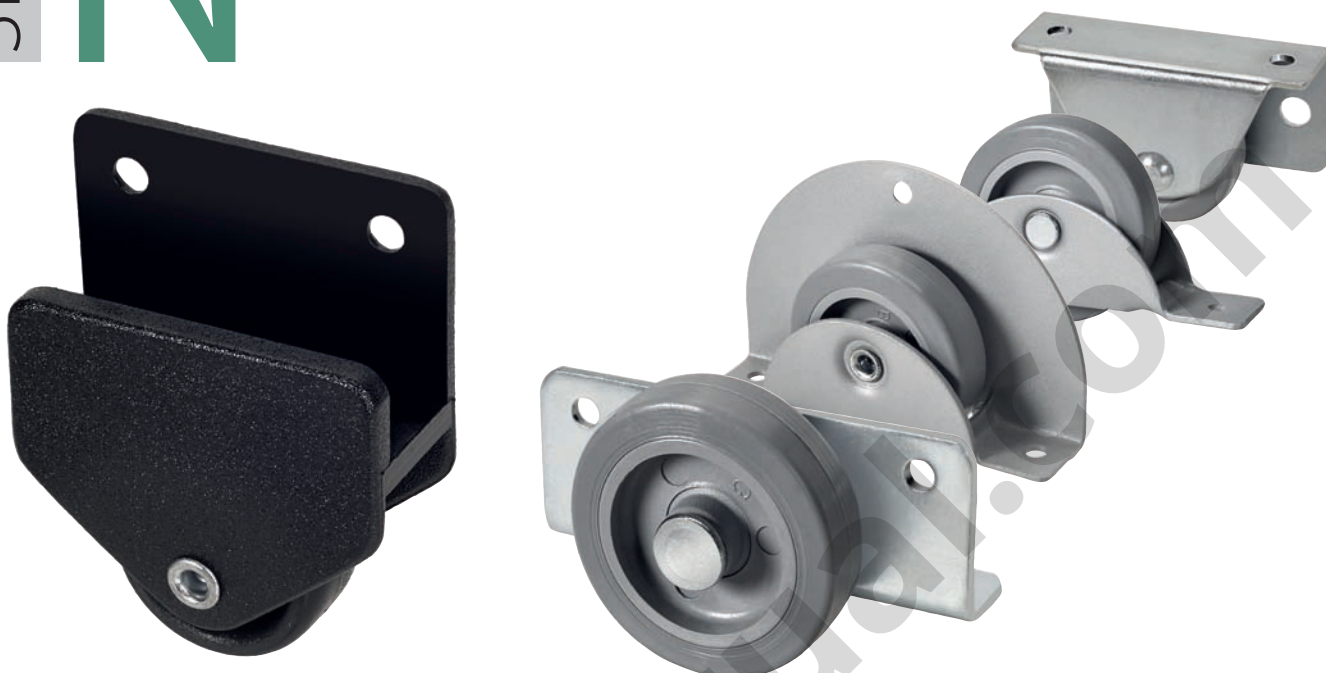

DETALLES DEL PRODUCTO

- ✓ Soporte embutido de chapa de acero o poliamix de hasta 2 m/m de espesor.
- ✓ Ruedas de Goma de 25, 30, 40, 50 de diámetro.
- ✓ Son ruedas silenciosas, no dejan huella, respetuosas con suelos de parquet, indeformables, resistentes y de fácil desplazamiento.
- ✓ Fabricadas según norma Europeas EN12528.
- ✓ Especialmente diseñadas para el sector mobiliario como: pequeños muebles, camas nido, canapés, mesas de noche, cajoneras, sofás, mobiliario de decoración, etc.



Rueda PGI

☹️ -20° a +60°

Goma gris

60 kg

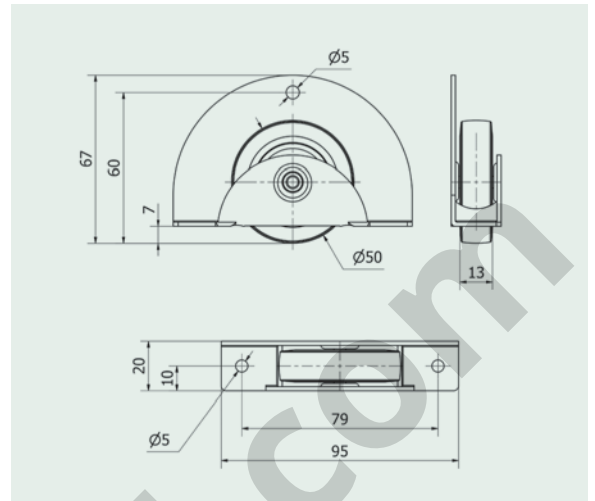

Cojinete

Eje

Material Acabado

Código



50	13	—	Acero	Pintado epoxi gris
----	----	---	-------	--------------------

1-0772	60
--------	----

60 kg

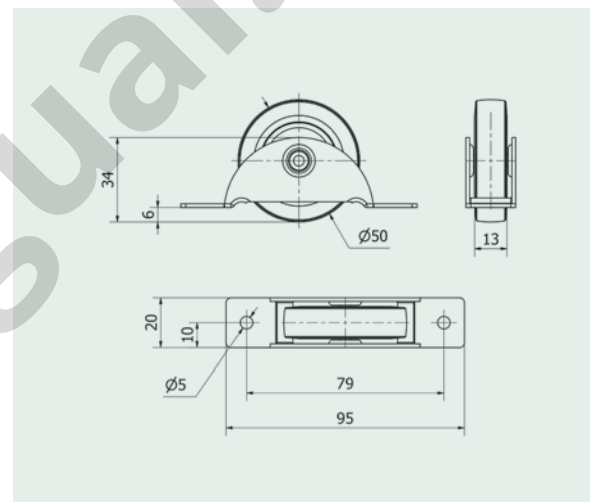

Cojinete

Eje

Material Acabado

Código



50	13	—	Acero	Pintado epoxi gris
----	----	---	-------	--------------------

1-0773	60
--------	----

45 kg

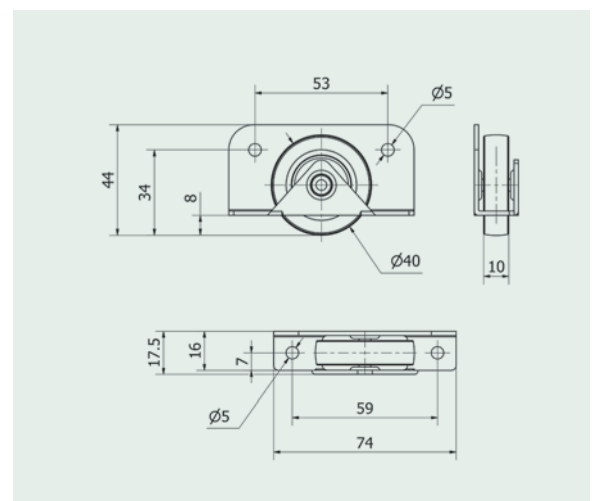
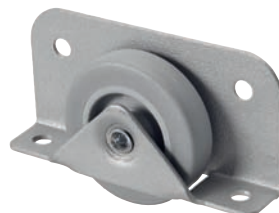

Cojinete

Eje

Material Acabado

Código



40	10	—	Acero	Pintado epoxi gris
----	----	---	-------	--------------------

1-0774	45
--------	----

Rueda PGI

☹️ -20° a +60°

Goma gris

60 kg

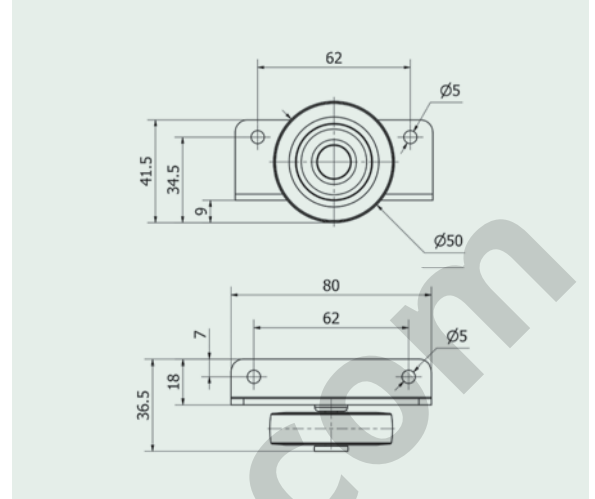
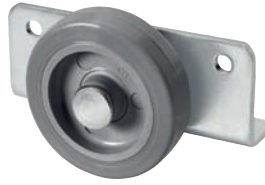

Cojinete

Eje

Material Acabado

Código



50	13	—	Acero	Cincado
----	----	---	-------	---------

1-0775	60
--------	----

40 kg

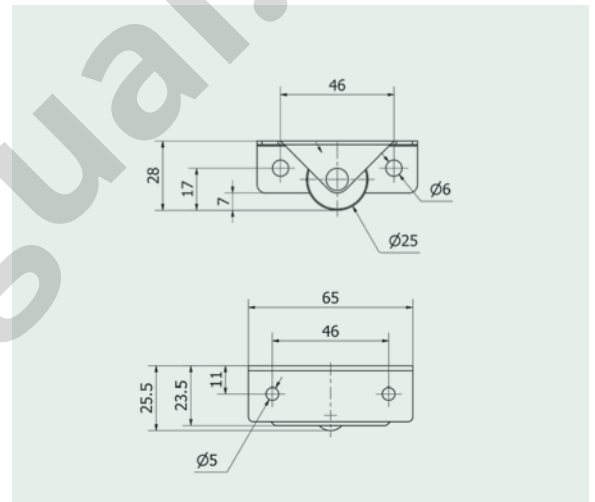

Cojinete

Eje

Material Acabado

Código



25	15	—	Acero	Cincado
----	----	---	-------	---------

1-0776	40
--------	----

30 kg

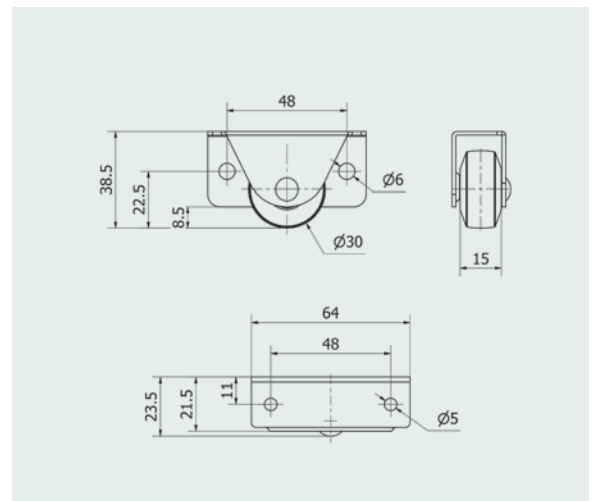

Cojinete

Eje

Material Acabado

Código



30	15	—	Acero	Cincado
----	----	---	-------	---------

1-0777	30
--------	----

Rueda BP

Poliamix
25 kg

☹️ -20° a +60°

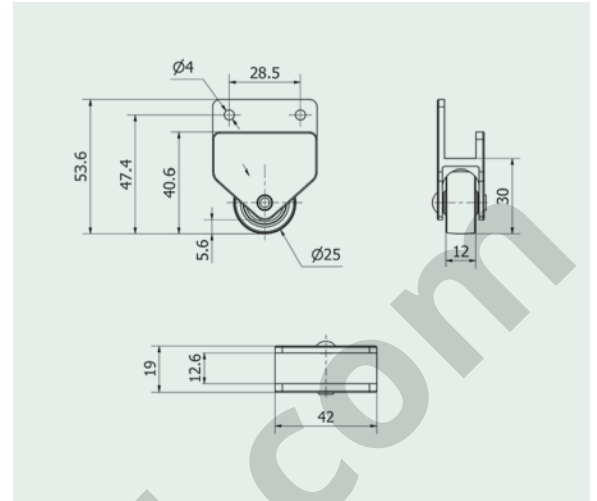

Cojinete

Eje

Material Acabado

Código



1-0778

25

25	12	—	Poliamix	Poliamix negro
----	----	---	----------	----------------



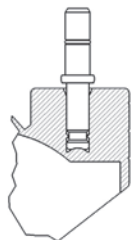

KG 20 - 60 kg 30 a 60 mm

- ✓ Fabricada en soporte de poliamida.
- ✓ Especialmente diseñadas para: sector mobiliario y restauración.

DK Negro

20 - 50 kg

Medidas Generales



Diameter	Width	Height	Rotation (GIRAT)
30	35x35	4	45
40	38x38	5	57
45	38x38	5	61
50	50x50	5	67



*** AMPLIAMOS GAMA**

Código	KG	Código	KG
* 1-0788	20	-	-
1-0239	20	1-0462	20
1-0241	30	-	-
1-0129	50	1-0404	50

*Detalle de planos de platina, ver página 34

20 - 60 kg



Diameter	Width	Height	Rotation (GIRAT)
30	-	6x15	40
40	-	6x15	52
45	-	8x15	57
50	-	8x15	63
50	-	10x15	63
60	-	10x15	72



*** AMPLIAMOS GAMA**

Código	KG	Código	KG
* 1-0789	20	-	-
1-0240	20	1-0464	20
1-0242	30	-	-
1-0125	50	1-0405	50
1-0127	50	1-0406	50
1-0332	60	1-0465	60

20 - 50 kg



Diameter	Width	Height	Rotation (GIRAT)
40	-	6x24	49
45	-	8x38	55
50	-	8x26	62



8 * ver página 246

Código	KG
1-0441	20
1-0394	30
1-0130	50

DK Negro

20 - 50 kg

Medidas Generales

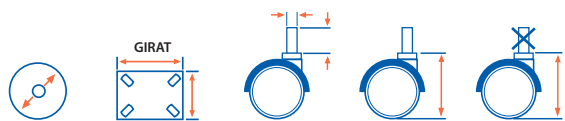

40	-	-	-	45
50	-	11x22	63	57



Código



-	-
1-0277	50



Código



2-2890	20
1-0118	50



Código



-	-
1-0119	50

- * 1-0120 Espiga roscada M10x15
- 1-0121 Espiga roscada M8x15
- 1-0122 Platina 42x42
- 1-0123 Espiga anilla 11x22

DK sillas de oficina

50 kg

Medidas Generales

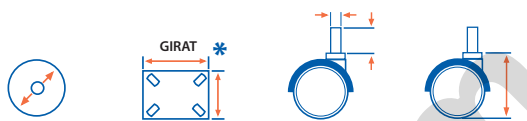

50	-	11x22	61
50	-	10x20	-



Código



1-0484	50
-	-



Código



1-0497	50
1-0787	50



DK poliuretano

50 kg

Medidas Generales



50	42x42	5	67
----	-------	---	----



Código



1-0642	50
---------------	----

Código



1-0643	50
---------------	----

* Detalle de planos de platina, ver página 34

50 kg

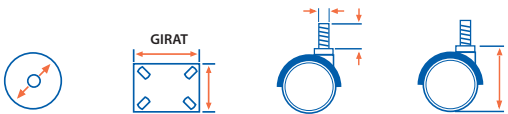

50	-	8x15	62
50	-	10x15	62



Código



1-0644	50
1-0645	50

Código



1-0646	50
1-0647	50

DK cromado-latonado

30 - 50 kg

Medidas Generales

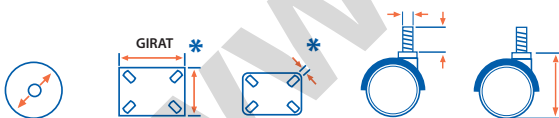

45	-	-	8x15	57
50	50x50	5	-	67
50	-	-	8x15	63



Código



-	-
1-0409	50
-	-

Código



1-0408	30
-	-
1-0410	50

Código



-	-
-	-
1-0498	50

* Detalle de planos de platina, ver página 34

* con acabado cromado la medida de la espiga es 10x15

80 - 120 kg **80 a 120 mm**

- ✓ Fabricada en soporte de poliamida.
- ✓ Especialmente diseñadas para: expositores, muebles, sillas de oficina...

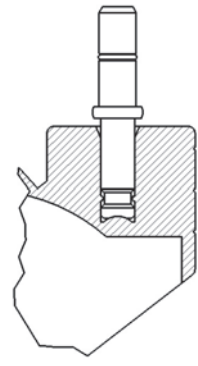

DK Negro

80 - 120 kg

Medidas Generales

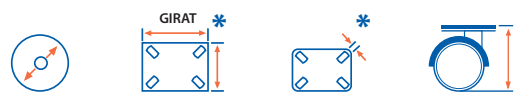

80	64x64	10	102
100	64x64	10	125
120	64x64	10	146

Código	KG	Código	KG
4-1319	80	4-1325	80
4-1320	100	4-1326	100
4-1321	120	4-1327	120

* Detalle de planos de platina, ver página 34

80 - 120 kg

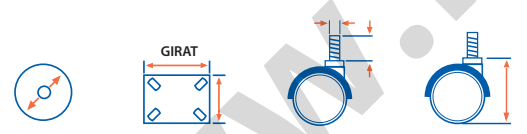

80	-	10x25	91
100	-	10x25	114
120	-	10x25	135

Código	KG	Código	KG
4-1322	80	4-1328	80
4-1323	100	4-1329	100
4-1324	120	4-1330	120

Para espigas de 8 mm



1-0371	10mm
1-0372	11mm
1-0373	12mm
1-0374	13mm
1-0375	14mm
1-0376	16mm
1-0377	17mm
1-0378	18mm
1-0379	19mm
1-0380	20mm
1-0411	22mm
1-0381	23mm
1-0412	26mm



1-0413	14mm
1-0382	17mm
1-0401	18mm
1-0383	22mm
1-0384	23mm
1-0385	27mm
1-0648	28mm

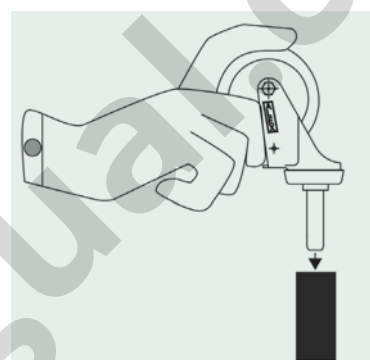
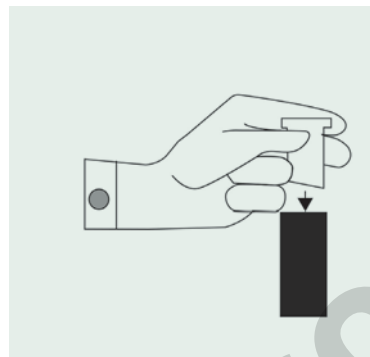

Para espigas de 11 mm



1-0655	17mm
1-0657	18mm
1-0653	20mm
1-0658	22mm
1-0654	23mm



1-0656	17mm
1-0663	18mm



Para espigas de 12 mm



1-0344	13mm
1-0345	14mm
1-0347	15mm
1-0349	16mm
1-0351	17mm
1-0353	18mm
1-0354	19mm
1-0355	20mm
1-0356	22mm
1-0357	23mm
1-0358	26mm



1-0359	14mm
1-0360	16mm
1-0361	17mm
1-0363	18mm
1-0364	20mm
1-0365	22mm
1-0367	23mm
1-0368	27mm
1-0369	28mm
1-0370	33mm

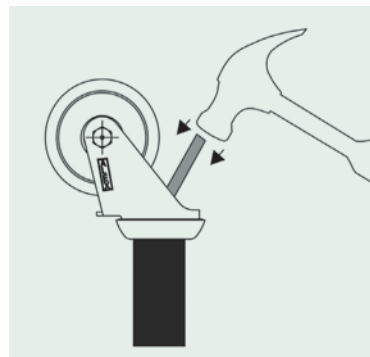

Ruedas

neumáticas

Hasta 300 kg por rueda

ÍNDICE

• Serie **ZV** pág. 248

• Serie **WL** pág. 252

• Serie **HLBI** pág. 256



ZV Neumática impinchable

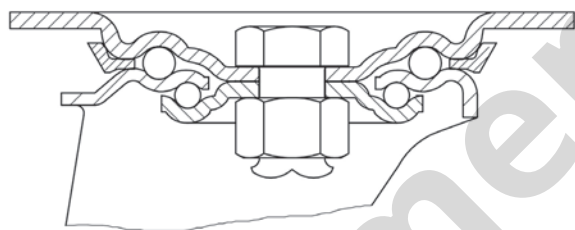

DETALLES DEL PRODUCTO

- ✓ Fabricada con chapa de acero hasta 4 m/m de espesor.
- ✓ Acabado cincado brillante.
- ✓ Silenciosas.
- ✓ No dejan huella.
- ✓ Especialmente diseñadas para usos institucionales en interiores.



75 kg



200 mm

» Fabricadas según normas europeas EN 12532

Medidas Generales

200	140x110	136x116	110x84/98x66	10	12	242	238	155

* Detalle de planos de platina, ver página 35

Rueda EM

Llanta metálica y cubierta elástica maciza

75 kg



200



50

Cojinete Eje



Código



75

2-1111

Código



75

2-1112

Código



75

2-1113

Rueda EP

Llanta de polipropileno y cubierta elástica maciza

75 kg



200



50

Cojinete Eje



Código



75

2-1108

Código



75

2-1109

Código



75

2-1110

200

50



Código

75

2-1117

Código

75

2-1118

Código

75

2-1119

Rueda RIL

Llanta metálica y cubierta neumática gris



75 kg



Cojinete
Eje

200

50



Código



4-1262

75

Código



4-1263

75

Código



2-3639

75

75 kg



Cojinete
Eje

200

50



Código



2-1028

75

Código



2-3640

75

Accesorios

Código						Tipo Cojinete Eje
2-1107	200	75	50	20	60	

Rueda Impinchable EM

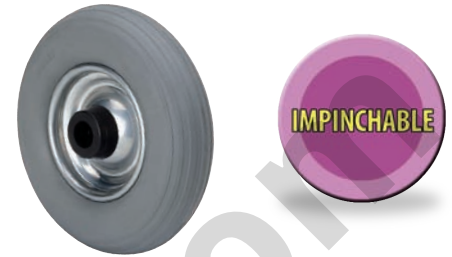

Accesorios

Código						Tipo Cojinete Eje
2-1106	200	75	50	20	60	
2-1116	200	75	50	20	60	

Rueda Impinchable EP



Accesorios

Código						Tipo Cojinete Eje	Lonas	Kit Presión Hinchado
4-0763	200	75	50	20	60		2	2
Cubierta-Recambio								
4-0764	200	–	50	–	–	–	2	–
Camara-Recambio								
4-0765	200	–	–	–	–	–	–	–

Neumático RIL



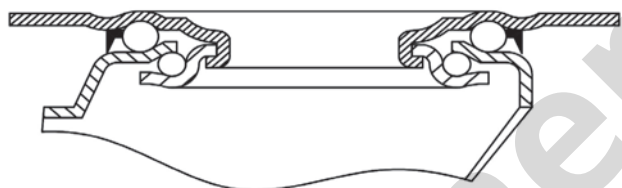

DETALLES DEL PRODUCTO

- ✓ Buena amortiguación a los golpes.
- ✓ Baja resistencia a la rodadura en suelos problemáticos.
- ✓ La cámara de aire protege el piso.
- ✓ Especialmente diseñadas para carretillas de reparto, carros portabotellas, bidones, remolques, carros de almacén, plataformas, etc.

100 - 220 kg
260 mm

- » Horquilla de chapa de acero embutida
- » Fabricadas según normas europeas EN 12532

Medidas Generales

260	175x140	175x140	140x105	10	-	294	-	200	

* Detalle de planos de platina, ver página 35

Rueda RIFN

Centro de poliamix

100 kg



* AMPLIAMOS GAMA



Cojinete
Eje

260	85	—
260	85	—

Código



4-1626	100
4-1646	100

Código



4-1627	100
4-1647	100

Código



* 4-0900	100
* 4-0901	100

IMPINCHABLE

Rueda RIFB

Centro metálico

100 kg



* AMPLIAMOS GAMA



Cojinete
Eje

260	85	●●
-----	----	----

Código



4-1628	100
--------	-----

Código



4-1629	100
--------	-----

Código



* 4-0902	100
----------	-----

IMPINCHABLE

Rueda RIP

Llanta de poliamix y cubierta neumática de 4 lonas

175 kg



* AMPLIAMOS GAMA



Cojinete Eje

260	85	—
260	85	▬

Código



4-1255	175
4-1256	175

Código



4-1258	175
4-1259	175

Código



4-0903	175
4-0904	175

Rueda RIT

Llanta metálica y cubierta neumática de 4 y 6 lonas

200 - 220 kg



* AMPLIAMOS GAMA



Cojinete Eje

Lonas

260	85	▬	4
260	85	●●	4
260	85	▬	6
260	85	●●	6

Código



4-0922	200
4-0924	200
4-1633	220
4-1635	220

Código



4-0923	200
4-0925	200
4-1634	220
4-1636	220

Código



4-0905	200
4-0926	200
4-0906	220
4-0907	220

Accesorios

Código						Tipo Cojinete Eje	Lonas	Kit Presión Hinchado
4-1566	260	100	85	20	75		-	-
4-1568	260	100	85	20	75		-	-

Rueda RIFN



Rueda RIFB



Código						Tipo Cojinete Eje	Lonas	Kit Presión Hinchado
4-1567	260	100	85	20	75		-	-

Accesorios

Código						Tipo Cojinete Eje	Lonas	Kit Presión Hinchado
4-1242	260	175	85	20	75		4	1,75
4-1243	260	175	85	20	75		4	1,75

Neumático RIP



Cubierta-Recambio

4-0767	260	-	85	-	-	-	4	-
---------------	-----	---	----	---	---	---	---	---

Camara-Recambio

4-0768	260	-	-	-	-	-	-	-
---------------	-----	---	---	---	---	---	---	---

Accesorios

Código						Tipo Cojinete Eje	Lonas	Kit Presión Hinchado
4-1027	260	200	85	20	75		4	2,5
4-1072	260	200	85	20	75		4	2,5
4-1637	260	220	85	20	75		6	3
4-1638	260	220	85	20	75		6	3

Neumático RIT



Cubierta-Recambio

4-0767	260	-	85	-	-	-	4	-
4-0770	260	-	85	-	-	-	6	-

Camara-Recambio

4-0768	260	-	-	-	-	-	-	-
---------------	-----	---	---	---	---	---	---	---

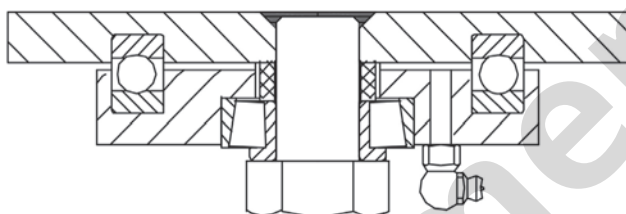

250 - 300 kg **320 a 400 mm**

» Fabricadas según normas europeas EN 12532/12533

DETALLES DEL PRODUCTO

- ✓ Chapa de acero de hasta 8 m/m de espesor
- ✓ Buena amortiguación a los golpes.
- ✓ Baja resistencia a la rodadura en suelos problemáticos.
- ✓ Mayor capacidad de carga.
- ✓ Especialmente diseñadas para carretillas de reparto, carros portabotellas, bidones, remolques, carros de almacén, plataformas, etc.

Medidas Generales

	GIRAT *	FJA *	GIRAT *				AGUJ	
320	180x170	180x170	150x135	16	-	368	-	290
400	180x170	180x170	150x135	16	-	455	-	299

* Detalle de planos de platina, ver página 35

Rueda RIT

Llanta metálica y cubierta neumática de 4 y 6 lonas

250 - 300 kg



Cojinete Eje

320	95	
400	100	

Código



4-1260	250
4-1032	300

Código



4-1261	250
4-1033	300

Accesorios

Código						Tipo Cojinete Eje	Lonas	Kit Presión Hinchado
4-1241	320	250	95	20	75		4	2,5
4-0929	320	250	95	25	75		4	2,5
4-0772	400	300	100	20	75		6	3,5
4-0928	400	300	100	25	75		6	3,5

Cubierta-Recambio

4-1028	320	-	95	-	-	-	4	-
4-1029	400	-	100	-	-	-	6	-

Camara-Recambio

4-1030	320	-	-	-	-	-	-	-
4-1031	400	-	-	-	-	-	-	-

Neumático RIT





Ruedas de decoración

Hasta 80 kg por rueda

ÍNDICE

- Serie **ALU** pág. 260
- Serie **BDM** pág. 260
- Serie **CLR** pág. 261
- Serie **BDT** pág. 261
- Serie **RD** pág. 262
- Serie **MDC** pág. 263
- Serie **BH** pág. 264
- Serie **BLS** pág. 265
- Serie **BLC** pág. 265
- Serie **DKP** pág. 266
- Serie **DKM** pág. 267

NOVEDAD

* AMPLIAMOS
GAMA



Medidas Generales

50	42x42	-	32x32	4	-	65	-	-
75	60x60	-	45x45	6	-	98	-	-
100	60x60	-	45x45	6	-	125	-	-

* Detalle de planos de platina, ver página 36

Serie ALU

ARO

- ✓ Aro de aluminio niquelado (efecto acero inoxidable) con doble banda de rodadura de poliuretano
- ✓ Diámetros: 50, 75, 100 mm

HORQUILLA

- Material: chapa de acero
- Acabado: niquelado
- Tipo de fijación: pletina giratoria
- Disponible: con freno (palanca negra)

40 - 50 kg



Acabados



Niquelado



Cojinete Eje Color

50	20		Aluminio
75	24		Aluminio
100	24		Aluminio

Código



1-0535	40
1-0536	45
1-0537	50

Código



1-0538	40
1-0539	45
1-0540	50

Serie BDM

ARO

- ✓ Aro de madera marrón oscuro (nogal) e inserciones de cromado pulido con doble banda de rodadura de poliuretano
- ✓ Diámetros: 50, 75, 100, 125 mm

HORQUILLA

- Material: chapa de acero
- Acabado: cromado pulido
- Tipo de fijación: pletina giratoria
- Disponible: con freno (palanca negra)

30 - 50 kg



Acabados



Cromado



Cojinete Eje Color

50	20,5		Marrón
75	24		Marrón
100	24,5		Marrón

Código



1-0574	30
1-0575	40
1-0576	50

Código



1-0578	30
1-0579	40
1-0580	50

Medidas Generales

	GIRAT *	FIJA *	GIRAT *	*	PLAT	AGUJ	
40	46x40	-	36x28	5	-	52	36
50	60x50	-	46x35	6	-	75	50
60	70x52	-	53x36	6	-	91	56

* Detalle de planos de platina, ver página 36

Serie CLR

ARO

- ✓ Rodamiento de bola en el eje
- ✓ Diámetros: 40, 50, 60 mm

HORQUILLA

- Material: chapa de acero
- Acabado: cromado pulido
- Tipo de fijación: pletina giratoria
- Disponible: con freno

20 - 40 kg



NOVEDAD

		Cojinete Eje	Color	Código	KG	Código	KG
40	16		Cromado pulido	1-0779	20	1-0782	20
50	20		Cromado pulido	1-0780	30	1-0783	30
60	22		Cromado pulido	1-0781	40	1-0784	40

Serie BDT

Medidas Generales

	GIRAT *	FIJA *	GIRAT *	*	PLAT	AGUJ	
50	42x42	-	33x32	4	-	64	-
75	60x60	-	45x45	6,4	-	95	-

* Detalle de planos de platina, ver página 36

ARO

- ✓ Centro de policarbonato y vandaje transparente de poliuretano.
- ✓ Diámetros: 50, 75 mm

HORQUILLA

- Material: chapa de acero
- Acabado: cromado pulido
- Tipo de fijación: pletina giratoria
- Disponible: con freno

40 - 60 kg



NOVEDAD

		Cojinete Eje	Color	Código	KG	Código	KG
50	20		Cromado pulido	1-0659	40	1-0660	40
75	22		Cromado pulido	1-0661	60	1-0662	60

Medidas Generales

75	60x60	-	45x45	6	-	98	-	-

* Detalle de planos de platina, ver página 37

Serie RD

ARO

- ✓ Aro con doble banda de rodadura de poliuretano de color y núcleo de acrílico transparente.
- ✓ Color del aro: rojo, amarillo, naranja, verde, azul o negro
- ✓ Diámetro: 75 mm

HORQUILLA

- Material: chapa de acero
- Acabado: cromado pulido
- Tipo de fijación: pletina giratoria
- Disponible: con freno (palanca negra)

40 kg



Colores



Rojo



Amarillo



Verde



Azul



Naranja



Negro

		Cojinete Eje	Color
75	23	—	Rojo
75	23	—	Amarillo
75	23	—	Naranja
75	23	—	Verde
75	23	—	Azul
75	23	—	Negro

Código	
1-0523	40
1-0524	40
1-0525	40
1-0526	40
1-0527	40
1-0528	40

Código	
1-0529	40
1-0530	40
1-0531	40
-	-
1-0533	40
1-0534	40

Medidas Generales

50	42x42	60x42	32x32	48x32	-	70	-	-
75	60x60	68x50	45x45	56x40	-	103	-	-

* Detalle de planos de platina, ver páginas 37

Serie MDC

ARO

- ✓ Aro con banda de rodadura de poliuretano y núcleo de policarbonato, en colores transparentes
- ✓ Color de los aros: azul, amarillo, verde, negro, naranja o rojo
- ✓ Diámetros: 50, 75 mm

HORQUILLA

- Material: chapa de acero
- Acabado: cromado pulido
- Tipo de fijación: pletina giratoria o fija
- Disponible: con freno (palanca transparente)

40 - 50 kg



Cojinete
Eje Color

Diámetro	Altura	Cojinete	Eje	Color
50	20	—	—	Azul
50	20	—	—	Amarillo
50	20	—	—	Verde
50	20	—	—	Negro
50	20	—	—	Naranja
50	20	—	—	Rojo
75	24	—	—	Azul
75	24	—	—	Amarillo
75	24	—	—	Verde
75	24	—	—	Negro
75	24	—	—	Naranja
75	24	—	—	Rojo

Código



Código	KG
1-0590	40
1-0591	40
1-0592	40
1-0593	40
1-0511	40
1-0512	40
1-0594	50
1-0595	50
1-0596	50
1-0597	50
1-0513	50
1-0514	50

Código



Código	KG
1-0598	40
1-0599	40
1-0600	40
1-0601	40
1-0515	40
1-0516	40
1-0602	50
1-0603	50
1-0604	50
1-0605	50
1-0517	50
1-0518	50

Código



Código	KG
1-0606	40
1-0607	40
1-0608	40
1-0609	40
1-0519	40
1-0520	40
1-0610	50
1-0611	50
1-0612	50
1-0613	50
1-0521	50
1-0522	50

Colores



Verde



Amarillo



Naranja



Azul



Negro



Rojo

Medidas Generales

60	70x55	-	54x38	6	10	88	85	62
80	70x55	-	54x38	6	10	112	108	77
100	70x55	-	54x38	6	10	134	130	90

* Detalle de planos de platina, ver página 37

Serie BH

ARO

- ✓ Aro de policarbonato
- ✓ Color de los aros: simil cristal, azul, rojo, amarillo y negro
- ✓ Diámetros: 60, 80, 100 mm

HORQUILLA

- Material: chapa de acero
- Acabado: cromado pulido o cincado
- Tipo de fijación: pletina giratoria o agujero pasante
- Disponible: con freno doble (palanca gris)

50 - 80 kg

* **AMPLIAMOS GAMA**



		Cojinete Eje	Color	Código cincado			*	Código cromado			Código	KG
				Código cincado	Código cromado	KG		Código cincado	Código cromado	KG		
60	24	—	Transparente	2-2274	2-2138	50	2-4808	2-4810	50	2-2166	60	
80	22	—	Transparente	2-2276	2-2140	70	2-2277	2-2143	70	2-2168	70	
100	25	—	Transparente	2-2280	2-2141	80	2-2281	2-2144	80	2-2169	80	

50 - 80 kg

* **AMPLIAMOS GAMA**



		Cojinete Eje	Color	Código cincado			*	Código cromado			Código	KG
				Código cincado	Código cromado	KG		Código cincado	Código cromado	KG		
60	24	—	Transparente	2-2275	2-2145	50	2-4809	2-4811	50	2-2167	60	
80	22	—	Transparente	2-2278	2-2147	70	2-2279	2-2150	70	2-2168	70	
100	25	—	Transparente	2-2282	2-2148	80	2-2283	2-2151	80	2-2169	80	

Colores *

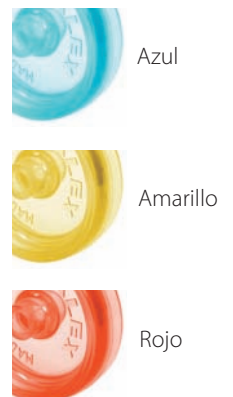

* Disponible en otros colores.
* Consultar disponibilidad en gama de colores.

Medidas Generales

50	42x42	-	32x32	4	-	70	-	-

* Detalle de planos de platina, ver página 37

Serie BLS

ARO

- ✓ Aro con forma de bola con banda de rodadura de PVC transparente con núcleo de polipropileno de colores
- ✓ Color de los aros: azul, amarillo, verde, negro o naranja
- ✓ Diámetros: 50 mm

HORQUILLA

- Material: chapa de acero
- Acabado: cromado satinado
- Tipo de fijación: pletina giratoria

40 kg



Colores



Azul



Verde



Amarillo



Naranja



Cojinete
Eje

Color

50	50	Cojinete Eje	Color
50	50	—	Azul
50	50	—	Amarillo
50	50	—	Verde
50	50	—	Naranja

Código



Código	KG
1-0582	40
1-0583	40
1-0584	40
1-0509	40

Serie BLC

ARO

- ✓ Aro con forma de bola con banda de rodadura de PVC transparente con núcleo de polipropileno de colores
- ✓ Color de los aros: azul, amarillo, verde, negro o naranja
- ✓ Diámetros: 50 mm

HORQUILLA

- Material: chapa de acero
- Acabado: cromado pulido
- Tipo de fijación: pletina giratoria

40 kg



Colores



Azul



Verde



Amarillo



Naranja



Cojinete
Eje

Color

50	50	Cojinete Eje	Color
50	50	—	Azul
50	50	—	Amarillo
50	50	—	Verde
50	50	—	Naranja

Código



Código	KG
1-0586	40
1-0587	40
1-0588	40
1-0510	40

Medidas Generales

50		42x42	-	32x32	5	8x15	73	84
60		50x50	-	38x38	5	10x25	83	103
75		50x50	-	38x38	5	10x25	98	118

* Detalle de planos de platina, ver página 38

Serie DKP

ARO

- ✓ Aro de nylon
- ✓ Color del aro: gris
- ✓ Color tapas laterales: plata
- ✓ Diámetros: 50, 60, 75 mm

HORQUILLA

- Material: nylon
- Acabado: plateado
- Tipo de fijación: pletina giratoria o espiga roscada
- Disponible: con freno

40 - 80 kg



		Cojinete	Eje	Color	Código	KG	Código	KG	Código	KG	Código	KG
50	41	—	—	Gris	1-0614	40	-	-	1-0620	40	1-0623	40
60	45	—	—	Gris	1-0615	60	-	-	1-0621	60	1-0624	60
75	47	—	—	Gris	1-0616	80	1-0619	80	1-0622	80	1-0625	80

Medidas Generales

50		42x42	-	32x32	5	8x15	73	84
60		50x50	-	38x38	5	10x25	83	103
75		50x50	-	38x38	5	10x25	98	118

* Detalle de planos de platina, ver página 38

Serie DKM

ARO

- ✓ Aro de nylon
- ✓ Color del aro: negro
- ✓ Color tapas laterales: haya
- ✓ Diámetros: 50, 60, 75 mm

HORQUILLA

- Material: nylon
- Acabado: haya
- Tipo de fijación: pletina giratoria o espiga roscada
- Disponible: con freno

40 - 80 kg



		Cojinete Eje	Color	Código	KG	Código	KG	Código	KG	Código	KG
50	41	—	Negro	1-0626	40	1-0629	40	1-0632	40	1-0635	40
60	45	—	Negro	1-0627	60	1-0630	60	1-0633	60	1-0636	60
75	47	—	Negro	1-0628	80	1-0631	80	1-0634	80	1-0637	80



Aros y Rodillos de recambio

ÍNDICE

- **Aros de Goma** pág. 270
- **Aros de Poliuretano** pág. 278
- **Aros de Nylon** pág. 284
- **Aros de Poliamix** pág. 286
- **Aros de Acero y Resina** pág. 288
- **Otros Aros** pág. 290
- **Rodillos para Transpaletas** pág. 292



Serie HG

Núcleo de acero y banda de goma con engrasador



VENTAJAS DEL ARO

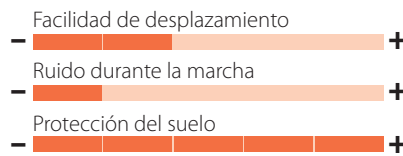

-20° a + 60°

Dureza 82-84° shore A

Código						Tipo Cojinete Eje	Color	Anti-hilos Código Añadir
4-0514	100	200	38	20	45		Negro	-
4-0516	125	250	38	20	45		Negro	-
4-0518	150	400	50	20	60		Negro	-
4-1642	150	400	50	25	60		Negro	-
4-0235	200	600	50	20	60		Negro	-
4-1643	200	600	50	25	60		Negro	-
4-0523	250	700	50	25	60		Negro	-
4-1639	250	750	75	25	82		Negro	-
4-0526	300	750	50	25	60		Negro	-
4-1640	300	850	75	25	82		Negro	-

Serie C

Núcleo metálico y banda de goma



VENTAJAS DEL ARO

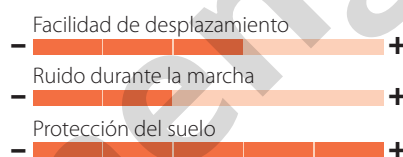

-20° a + 60°

Dureza 85° shore A

Código						Tipo Cojinete Eje	Color	Anti-hilos Código Añadir
2-0083	200	300	38	20	55		Negro	-
2-0078	200	300	38	20	55		Negro	-
2-0084	250	400	50	25	64		Negro	-
2-0079	250	400	50	25	66		Negro	-
2-0085	300	450	53	25	71		Negro	-
2-0080	300	450	53	25	71		Negro	-

Aros de goma

Serie BS

Núcleo metálico
y banda de goma



VENTAJAS DEL ARO

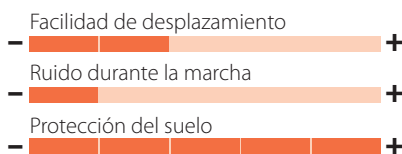

-20° a +60°

Dureza 85° shore A

Código		KG				Tipo Cojinete Eje	Color	Anti-hilos Código Añadir
2-0411	80	80	27	15	40		Negro	2-0816
2-0412	100	110	27	15	40		Negro	2-0816
4-0743	125	140	35	15	40		Negro	2-0816
4-0744	160	180	37	20	60		Negro	-
4-0745	200	230	46	20	60		Negro	2-0818
4-0752	250	250	50	20	60		Negro	-

Serie PGM

Núcleo de poliamix
y banda de goma azul



VENTAJAS DEL ARO

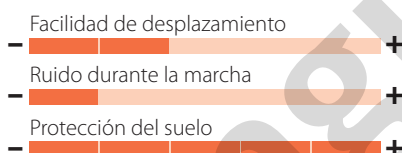

-20° a +70°

Dureza 65-70° shore A

*** AMPLIAMOS GAMA**

Código		KG				Tipo Cojinete Eje	Color	Anti-hilos Código Añadir
2-3496	80	120	34	12	40		Azul	-
2-2755	100	170	36	12	40		Azul	-
* 2-4427	100	170	36	8	43		Azul	Incluidos
2-2756	125	225	36	12	40		Azul	-
* 2-4428	125	225	36	8	43		Azul	Incluidos
2-4259	150L	300	36	8	43		Azul	Incluidos
2-2757	160	350	45	20	60		Azul	-
* 2-4429	160	350	45	20	60		Azul	-
2-2758	200	400	45	20	60		Azul	-
* 2-4430	200	400	45	20	60		Azul	-

Serie PGR

Goma elástica gris



VENTAJAS DEL ARO

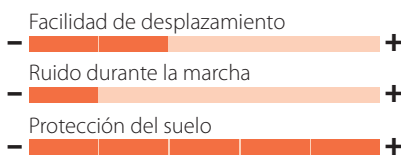

-20° a +70°

Dureza 70° shore A



Código						Tipo Cojinete Eje	Color	Anti-hilos Código Añadir
2-3746	80	120	34	12	40		Gris	-
2-3747	100	170	36	12	40		Gris	-
2-3748	125	225	36	12	40		Gris	-
2-3749	160	350	45	20	60		Gris	-
2-3750	200	400	45	20	60		Gris	-

Serie PGA

Núcleo de poliamix y banda de goma gris



VENTAJAS DEL ARO

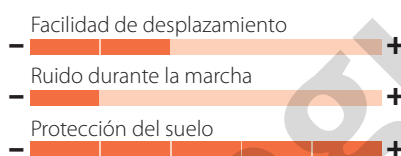

-20° a +60°

Dureza 85° shore A

Código						Tipo Cojinete Eje	Color	Anti-hilos Código Añadir
2-1312	80	80	32	12	40		Gris	2-2454
2-0807	80	80	32	8	40		Gris	2-2454
2-0784	100	110	32	12	40		Gris	2-4484
2-1124	100	110	32	8	40		Gris	2-4484
2-0790	125	135	32	12	40		Gris	2-0822
2-1125	125	135	32	8	40		Gris	2-0822
2-1252	150	140	32	12	40		Gris	2-4485
2-1253	150	140	32	8	40		Gris	2-4485
2-1569	200	160	32	8	42		Gris	Incluidos

Nota: para **Anti-hilos inoxidable brillante**: Ø100 Solicitar código: **2-0821**
 Ø125 Solicitar código: **2-2809**
 Ø150 Solicitar código: **2-0815**

Serie PGI

Núcleo de poliamix y banda de goma gris



VENTAJAS DEL ARO

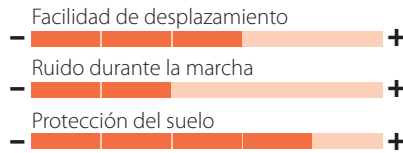

-20° a +60°

Dureza 90° shore A

Código						Tipo Cojinete Eje	Color	Anti-hilos Código Añadir
1-0324	30	15	16	5	20		Gris	-
1-0467	30	15	16	6	18,5		Gris	-
1-0468	40	17	16	5	22		Gris	-
1-0319	40	25	16	8	20		Gris	-
1-0399	50	30	18	10	20		Gris	2-2452
1-0321	60	35	18	10	20		Gris	2-1563
2-1064	60	40	22	10	27		Gris	2-1563
2-0806	80	60	24	10	27		Gris	2-0820
2-0787	100	70	25	10	27		Gris	2-0820

Serie PGAIB

Núcleo de poliamix y banda de goma gris termoplástica



VENTAJAS DEL ARO

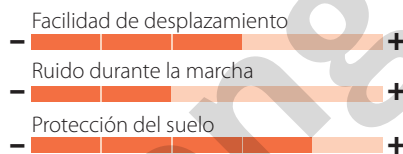

-20° a +60°

Dureza 90° shore A

Código						Tipo Cojinete Eje	Color	Anti-hilos Código Añadir
2-2759	100	100	32	8	43		Gris	Incluidos
2-1146	125	125	32	8	43		Gris	Incluidos
2-3577	150	125	32	8	43		Gris	Incluidos

Serie PGIB

Núcleo de poliamix y banda de goma gris



VENTAJAS DEL ARO

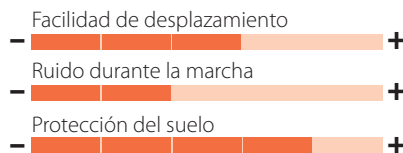

-20° a +60°

Dureza 90° shore A

Código						Tipo Cojinete Eje	Color	Anti-hilos Código Añadir
2-2891	80	70	25	6	28		Gris	Incluidos
2-2892	100	80	25	6	28		Gris	Incluidos

Serie DE

Núcleo de aluminio y banda de goma elástica



VENTAJAS DEL ARO

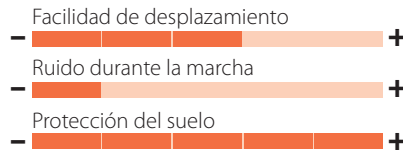

-20° a +70°

Dureza 70° shore A

Código						Tipo Cojinete Eje	Color	Anti-hilos Código Añadir
4-0995	100	200	40	15	41		Negro	-
4-1606	125	250	40	15	41		Negro	-
4-0996	125	250	40	20	50		Negro	-
4-0475	125	300	50	20	56		Negro	-
4-0997	160	350	50	20	60		Negro	-
2-4061	160	350	50	25	60		Negro	-
4-0998	200	450	50	20	60		Negro	-
4-1565	200	450	50	25	60		Negro	-
4-0999	250	500	50	25	60		Negro	-

Serie DEGB

Núcleo de aluminio y banda de goma gris elástica



VENTAJAS DEL ARO

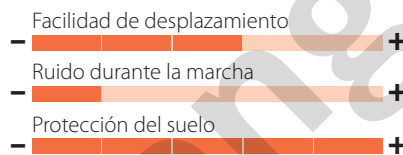

-20° a +60°

Dureza 70° shore A



NOVEDAD

Código						Tipo Cojinete Eje	Color	Anti-hilos Código Añadir
4-1659	160	350	50	20	60		Gris	-
4-1667	160	350	50	25	60		Gris	-
4-1660	200	450	50	20	60		Gris	-
4-1668	200	450	50	25	60		Gris	-

Serie J

Núcleo metálico y banda de goma



VENTAJAS DEL ARO

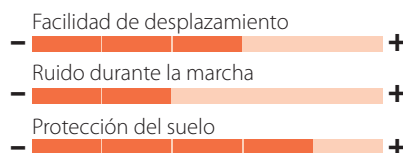

-20° a +60°

Dureza 80° shore A

Código						Tipo Cojinete Eje	Color	Anti-hilos Código Añadir
2-0209	200	160	35	20	40		Negro	-
2-0368	230	200	36	20	40		Negro	-
2-0369	250	230	40	20	40		Negro	-

Serie CA

Núcleo metálico
y banda de goma



VENTAJAS DEL ARO

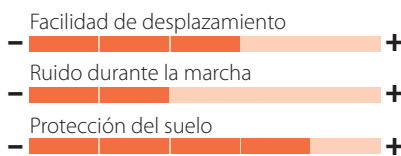

-20° a +60°

Dureza 70° shore A

Código		KG				Tipo Cojinete Eje	Color	Anti-hilos Código Añadir
2-0799	300	150	60	20	60		Negro	-
4-0782	350	120	70	25	60		Negro	-
4-0783	400	390	90	25	80		Negro	-

Serie PGZ

Núcleo de poliamix
y banda de goma gris
inyectada



VENTAJAS DEL ARO

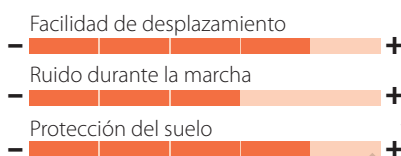

-25° a +80°

Dureza 90° shore A

Código		KG				Tipo Cojinete Eje	Color	Anti-hilos Código Añadir
2-3142	80	80	28	12	40		Gris	-
2-3147	80	80	28	12	40		Gris	-
2-3310	80	80	28	12	40	*	Gris	-
2-3143	100	100	30	12	40		Gris	2-0822
2-3148	100	100	30	12	40		Gris	2-0822
2-3311	100	100	30	12	40	*	Gris	2-2809
2-3144	125	120	32	12	40		Gris	2-4485
2-3149	125	120	32	12	40		Gris	2-4485
2-3312	125	120	32	12	40	*	Gris	2-0815
2-3145	160	160	38	20	60		Gris	4-1190
2-3146	200	180	45	20	60		Gris	4-1582

*cojinete de rodillos inoxidable

Serie TPG

Núcleo de nylon negro y banda de goma



VENTAJAS DEL ARO

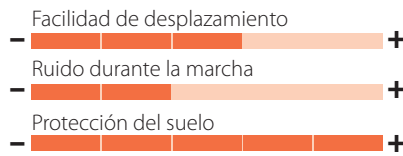

-20° a +60°

Dureza 80° shore A

Código						Tipo Cojinete Eje	Color	Anti-hilos Código Añadir
2-0059	80	110	35	12	41		Negro	-
2-1226	80	110	35	12	41		Negro	-
2-0060	100	130	35	12	41		Negro	-
2-1251	100	130	35	12	41		Negro	-
2-0061	125	200	44	16	51		Negro	2-0819
2-0785	125	200	44	17	53		Negro	2-0819
2-0062	150	280	50	20	58		Negro	2-0817
2-0786	150	280	50	20	53		Negro	2-0817

Serie PS

Núcleo de poliamix y banda de goma



VENTAJAS DEL ARO

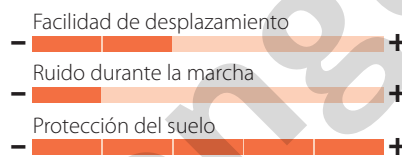

-20° a +60°

Dureza 75° shore A

Código						Tipo Cojinete Eje	Color	Anti-hilos Código Añadir
2-0848	80	75	27	12	40		Negro	-
2-0849	100	100	27	12	40		Negro	-
2-0850	125	125	35	12	40		Negro	-
2-0851	150	150	35	12	40		Negro	-
2-0852	160	160	40	20	60		Negro	-
2-1122	160	160	40	20	60		Negro	-
* 2-4739	160	160	40	20	60		Negro	-
2-0853	200	215	47	20	60		Negro	2-1250
2-1123	200	215	47	20	60		Negro	2-1250
* 2-4740	200	215	47	20	60		Negro	-

*cojinete de rodillos inoxidable

Serie PS GRIS

Núcleo de poliamix y banda de goma gris



VENTAJAS DEL ARO

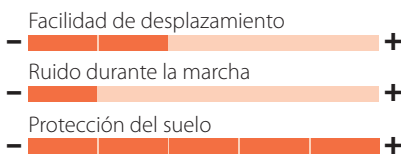

-20° a +60°

Dureza 80° shore A

*** AMPLIAMOS GAMA**

Código						Tipo Cojinete Eje	Color	Anti-hilos Código Añadir
2-3397	160	160	40	20	60		gris	-
2-3398	160	160	40	20	60		gris	-
* 2-4741	160	160	40	20	60		gris	-
2-3548	160	160	40	12	60		gris	incluido
2-3395	200	215	47	20	60		gris	2-1250
2-3396	200	215	47	20	60		gris	2-1250
* 2-4742	200	215	47	12	60		gris	-
2-3549	200	215	47	12	60		gris	incluido

*cojinete de rodillos inoxidable

Serie PI

Núcleo de poliamix y banda de goma



VENTAJAS DEL ARO

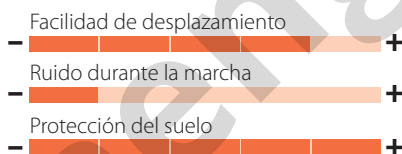

-20° a +60°

Dureza 95° shore A

Código						Tipo Cojinete Eje	Color	Anti-hilos Código Añadir
4-1562	80	30	26	8	35		Negro	-
4-1563	100	35	30	10	35		Negro	-
4-1564	125	50	35	15	44		Negro	-
4-1290	150	80	38	15	44		Negro	-
4-1291	175	100	41	20	58		Negro	-
4-1292	200	120	48	20	58		Negro	-
4-1293	250	130	48	25	58		Negro	-
4-1294	300	150	60	25	74		Negro	-

Serie HU

Núcleo de acero y banda de poliuretano
Cojinete LISO

VENTAJAS DEL ARO

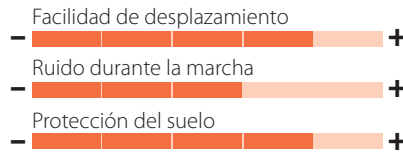

-20° a +60°

Dureza 95° shore A

*** AMPLIAMOS GAMA**



Código						Tipo Cojinete Eje	Color	Anti-hilos Código Añadir
4-1608	250	2.000	70	25	82		Naranja	-
4-1609	300	2.600	70	30	82		Naranja	-
4-1623	400	4.000	80	60	90		Naranja	-
4-1610	400	5.000	120	60	130		Naranja	-

Serie HUB

Núcleo de acero y banda de poliuretano
Cojinete BOLAS

VENTAJAS DEL ARO

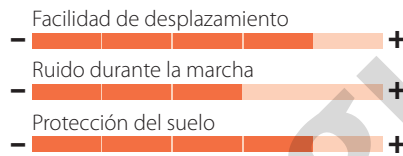

-20° a +60°

Dureza 95° shore A



Código						Tipo Cojinete Eje	Color	Anti-hilos Código Añadir
2-1746	100	350	40	20	48		Naranja	-
2-1747	125	400	40	20	48		Naranja	-
2-1748	150	800	50	20	60		Naranja	-
4-1644	150	800	50	25	60		Naranja	-
2-3604	180	900	50	20	60		Naranja	-
2-1749	200	1.100	50	20	60		Naranja	-
4-1645	200	1.100	50	25	60		Naranja	-
2-1750	250	1.250	50	25	60		Naranja	-
2-3437	250	1.600	75	25	82		Naranja	-
4-1652	250	1.600	75	30	79		Naranja	-
4-0546	300	1.400	50	25	60		Naranja	-
2-3438	300	2.000	75	25	82		Naranja	-
4-1653	300	2.000	75	30	79		Naranja	-
2-3439	300	2.800	100	30	100		Naranja	-
2-3440	400	3.500	100	50	120		Naranja	-

Aros de poliuretano

Serie HUAB

Núcleo de acero y banda de poliuretano
Forma balona



VENTAJAS DEL ARO

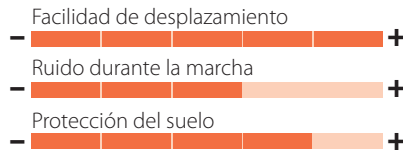

-20° a +60°

Dureza 95° shore A

Código		KG				Tipo Cojinete Eje	Color	Anti-hilos Código Añadir
2-3313	150	600	50	20	56		Naranja	-
2-4059	150	600	50	25	56		Naranja	-
2-3314	200	800	50	20	60		Naranja	-
2-4060	200	800	50	25	60		Naranja	-

Rueda con banda de rodadura en forma balona. **Menor esfuerzo al giro y desplazamiento.**

Serie AUB

Núcleo de aluminio y banda de poliruteano



VENTAJAS DEL ARO

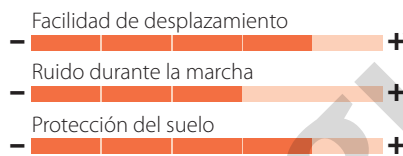

-20° a +60°

Dureza 95° shore A

*** AMPLIAMOS GAMA**

Código		KG				Tipo Cojinete Eje	Color	Anti-hilos Código Añadir
* 2-4651	80	150	38	15	41		Naranja	-
2-2546	100	200	38	15	41		Naranja	-
2-2547	125	250	38	15	41		Naranja	-
* 2-4520	125	400	40	20	48		Naranja	-
2-2548	160	600	50	20	60		Naranja	-
2-2549	200	800	50	20	60		Naranja	-
2-2550	250	1000	60	25	60		Naranja	-

Serie AUAB

Núcleo de aluminio y banda de poliuretano
Forma balona



VENTAJAS DEL ARO

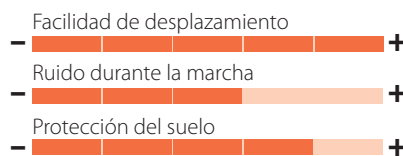

-20° a +60°

Dureza 95° shore A

*** AMPLIAMOS GAMA**

Código		KG				Tipo Cojinete Eje	Color	Anti-hilos Código Añadir
* 2-4812	125	225	38	12	41		Naranja	-
2-3992	160	550	50	20	60		Naranja	-
2-3993	200	750	50	20	60		Naranja	-

Rueda con banda de rodadura en forma balona. **Menor esfuerzo al giro y desplazamiento.**

Serie AUGB

Núcleo de aluminio y banda de poliuretano verde



VENTAJAS DEL ARO

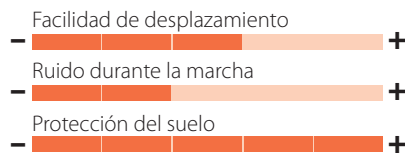

-20° a +60°

Dureza 80° shore A

Código						Tipo Cojinete Eje	Color	Anti-hilos Código Añadir
4-1654	160	550	50	20	60		Verde	-
4-1641	200	700	50	20	60		Verde	-

Rueda de poliuretano verde. **Mayor elasticidad.**

Serie AUAGB

Núcleo de aluminio y banda de poliuretano verde. Forma balona



VENTAJAS DEL ARO

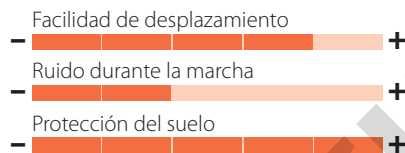

-20° a +60°

Dureza 80° shore A

NOVEDAD

Código						Tipo Cojinete Eje	Color	Anti-hilos Código Añadir
4-1661	160	500	50	20	60		Verde	-
4-1662	200	650	50	20	60		Verde	-

Rueda con banda de rodadura en forma balona. **Menor esfuerzo al giro y desplazamiento.**

Serie AUSB

Núcleo de aluminio y banda de poliuretano blanco



VENTAJAS DEL ARO

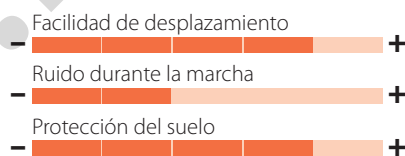

-20° a +60°

Dureza 88° +/- shore A

RUEDA DE VELOCIDAD

Código						Tipo Cojinete Eje	Color	Anti-hilos Código Añadir
4-1657	160	600	50	20	60		Blanco	-
4-1658	200	750	50	20	60		Blanco	-

Ruedas recomendadas para desplazamientos en velocidad (hasta 16 Km/h)

Cargas recomendadas según velocidad: 6 km/h -20%, 10 km/h -40%, 16 km/h -60%

Aros de poliuretano

Serie PO

Núcleo de nylon blanco y banda de poliuretano rojo

VENTAJAS DEL ARO

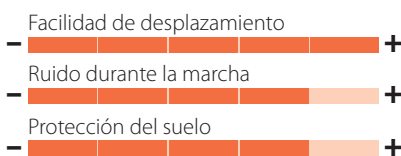

-25° a + 80°

Dureza 60° shore D

AMPLIAMOS GAMA



Código						Tipo Cojinete Eje	Color	Anti-hilos Código Añadir
* 2-4673	80	200	32	12	40		Rojo	-
* 2-4629	80	200	32	15	40		Rojo	-
2-1443	100	200	33	12	40		Rojo	2-0822
4-0479	100	200	33	17	40		Rojo	2-0822
4-0480	125	300	42	16	50		Rojo	4-1581
4-0481	125	300	42	17	50		Rojo	4-1581
4-0482	150	450	42	20	60		Rojo	4-1190
4-0484	150	450	42	20	55		Rojo	4-1190
4-0485	150	450	42	25	55		Rojo	4-1190
4-0486	200	600	50	20	60		Rojo	4-1582
4-0488	200	600	50	20	52		Rojo	4-1582

Serie POL

Núcleo de poliamix blanco y banda de poliuretano marrón

VENTAJAS DEL ARO

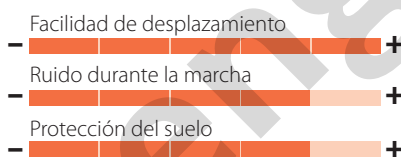

-25° a + 80°

Dureza 60° shore D



Código						Tipo Cojinete Eje	Color	Anti-hilos Código Añadir
2-2500	80	100	32	12	40		Marrón	2-4484
2-2959	80	100	32	12	40		Marrón	2-4484
2-3493	80	100	32	12	40	*	Marrón	2-0821
2-4195	80	100	32	8	43		Marrón	Incluidos
2-2480	100	150	32	12	40		Marrón	2-0822
2-2960	100	150	32	12	40		Marrón	2-0822
2-3494	100	150	32	12	40	*	Marrón	2-2809
2-4196	100	150	32	8	43		Marrón	Incluidos
2-2481	125	200	32	12	40		Marrón	2-4485
2-2961	125	200	32	12	40		Marrón	2-4485
2-3495	125	200	32	12	40	*	Marrón	2-0815
2-4197	125	200	32	8	43		Marrón	Incluidos
2-2482	150	250	42	20	60		Marrón	4-1190
2-3441	150	250	42	20	60		Marrón	4-1190
2-3445	150	250	42	20	60	*	Marrón	-
2-2483	200	300	50	20	60		Marrón	4-1582
2-3442	200	300	50	20	60		Marrón	4-1582
2-3446	200	300	50	20	60	*	Marrón	-

*cojinete de rodillos inoxidable

Serie POA

Núcleo de poliamix blanco y banda de poliuretano blando azul

VENTAJAS DEL ARO

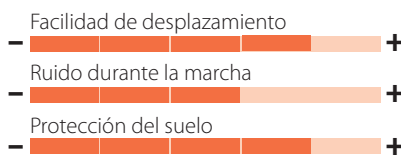

-25° a + 80°

Dureza 80° shore A



Código						Tipo Cojinete Eje	Color	Anti-hilos Código Añadir
2-2850	80	100	32	12	40		Azul	2-4484
2-2962	80	100	32	12	40		Azul	2-4484
2-3202	80	100	32	12	40		Azul	2-0821
2-4198	80	100	32	8	40		Azul	Incluidos
2-2851	100	150	32	12	40		Azul	2-0822
2-2963	100	150	32	12	40		Azul	2-0822
2-3203	100	150	32	12	40		Azul	2-2809
2-4199	100	150	32	8	40		Azul	Incluidos
2-2852	125	175	32	12	40		Azul	2-4485
2-2964	125	175	32	12	40		Azul	2-4485
2-3204	125	175	32	12	40		Azul	2-0815
2-4200	125	175	32	8	40		Azul	Incluidos
2-2853	150	200	42	20	60		Azul	4-1190
2-3443	150	200	42	20	60		Azul	4-1190
2-3447	150	200	42	20	60		Azul	-
2-2854	200	250	50	20	60		Azul	4-1582
2-3444	200	250	50	20	60		Azul	4-1582
2-3448	200	250	50	20	60		Azul	-

*cojinete de rodillos inoxidable

Rueda de poliuretano azul. **Desplazamiento más silencioso y absorción de vibraciones.**

Serie PUA

Núcleo de poliamix negro y banda de poliuretano azul

VENTAJAS DEL ARO

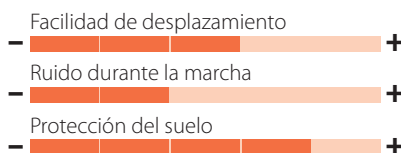

-25° a + 80°

Dureza 80° shore A

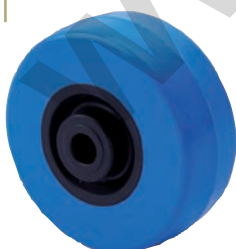

Código						Tipo Cojinete Eje	Color	Anti-hilos Código Añadir
2-3508	30	15	16	5	20		Azul	-
2-3509	40	25	16	5	21		Azul	-
2-3510	50	40	18	10	20		Azul	2-2452
2-3511	60	60	18	10	21		Azul	2-1563

Aros de poliuretano



Serie PU

Núcleo de polipropileno y banda de poliuretano gris

VENTAJAS DEL ARO

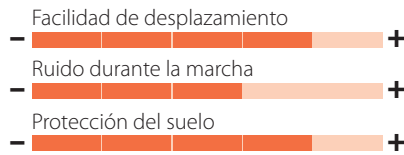

-25° a +80°

Dureza 60° shore D



Código						Tipo Cojinete Eje	Color	Anti-hilos Código Añadir
2-1100	100	175	32	8	43		Gris	Incluidos
2-1037	125	200	32	8	43		Gris	Incluidos
2-3583	150	200	32	8	43		Gris	Incluidos

Serie PGC

Núcleo de polipropileno y banda de poliuretano gris **conductivo**

VENTAJAS DEL ARO

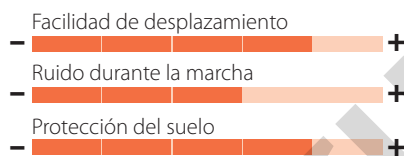

-25° a +80°

Dureza 95° shore A



Código						Tipo Cojinete Eje	Color	Anti-hilos Código Añadir
2-1602	80	100	32	8	36		Gris	Incluidos
2-1603	100	175	32	8	43		Gris	Incluidos
2-1604	125	200	32	8	43		Gris	Incluidos
2-1605	150	200	32	8	43		Gris	Incluidos

Serie PPI

Núcleo de poliamix y banda de poliuretano

VENTAJAS DEL ARO

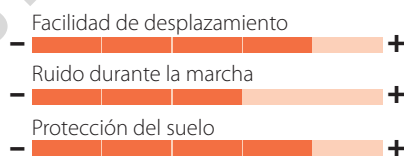

-25° a +80°

Dureza 60° shore D



Código						Tipo Cojinete Eje	Color	Anti-hilos Código Añadir
2-2558	30	15	16	5	20		Rojo	-
2-2559	40	25	16	5	21		Rojo	-
2-2560	50	40	18	10	20		Rojo	2-2452
2-2561	60	60	18	10	21		Rojo	2-1563
2-2521	60	70	22	10	27		Rojo	2-1563
2-2477	80	80	24	10	27		Rojo	2-0820
2-2475	100	100	25	10	27		Rojo	2-0820
* 2-4680	100	150	32	12	40		Rojo	2-0822
2-2456	125	200	32	12	40		Rojo	2-4485

Serie NF

Rueda de nylon fundido para cargas superpesadas *

VENTAJAS DEL ARO

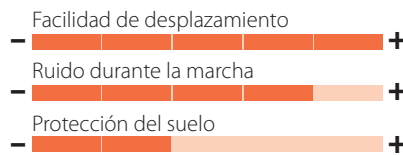

-30° a +80°

Dureza 80° shore D

*** AMPLIAMOS GAMA**



Código						Tipo Cojinete Eje	Color	Anti-hilos Código Añadir
* 2-4357	100	1.250	55	25	60		Blanco	-
* 2-4358	125	1.400	55	25	60		Blanco	-
* 2-4359	150	2.750	80	35	85		Blanco	-
2-3601	200	4.500	80	45	85		Blanco	-
2-3602	250	6.000	80	50	85		Blanco	-
2-3603	300	7.000	80	50	85		Blanco	-

* Se recomiendan tiempos de reposo prolongados para evitar una sobrecarga térmica.

Serie FT

Rueda de nylon extrafuerte

VENTAJAS DEL ARO

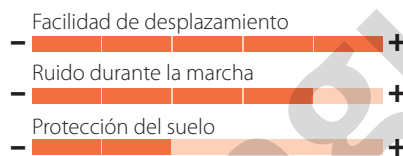

-30° a +80°

Dureza 75° shore D



Código						Tipo Cojinete Eje	Color	Anti-hilos Código Añadir
4-0001	50	50	19	6,4	27		Blanco	-
4-0002	60	125	22	9,5	33		Blanco	-
4-0003	80	300	30	12	40		Blanco	4-1187
4-1535	100	400	32	12	40		Blanco	4-1188
4-0004	100	400	32	14	50		Blanco	4-1188
4-0005	100	400	32	17	40		Blanco	4-1188
4-1607	125	400	34	12	41		Blanco	-
4-0007	125	600	42	16	52		Blanco	4-1189
4-0008	125	600	42	17	50		Blanco	4-1189
4-0009	150	900	45	20	60		Blanco	4-1190
4-0010	150	900	45	25	60		Blanco	-
4-0011	150	900	45	20	55		Blanco	4-1190
4-0012	150	900	45	25	55		Blanco	4-1190
4-0013	200	1.000	50	20	60		Blanco	-
4-0014	200	1.000	50	25	60		Blanco	-
4-0015	200	1.000	50	20	52		Blanco	-
4-0016	200	1.000	50	25	52		Blanco	-
4-0017	250	1.250	57	25	60		Blanco	-
4-0018	250	1.250	57	25	57		Blanco	-
4-0019	250	1.250	57	30	57		Blanco	-

Serie TN

Rueda de nylon blanco



VENTAJAS DEL ARO

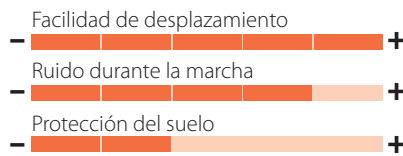

-30° a +80°

Dureza 75° shore D

* **AMPLIAMOS GAMA**

Código						Tipo Cojinete Eje	Color	Anti-hilos Código Añadir
2-0067	80	250	35	12	41	—	Blanco	4-1187
2-0159	80	250	35	12	41	—	Blanco	4-1187
2-0068	100	300	35	12	41	—	Blanco	4-0292
2-0160	100	300	35	12	41	—	Blanco	4-0292
2-0069	125	350	45	16	52	—	Blanco	2-0825
2-0163	125	350	45	17	50	●●	Blanco	2-0825
2-0070	150	650	45	20	60	—	Blanco	2-0826
2-0164	150	650	45	20	50	●●	Blanco	2-0826
* 2-4551	180	650	50	20	50	●●	Blanco	-
2-0071	200	750	50	20	60	—	Blanco	2-0827
2-0165	200	750	50	20	52	●●	Blanco	2-0827

Serie UT

Rueda de poliamix blanco



VENTAJAS DEL ARO

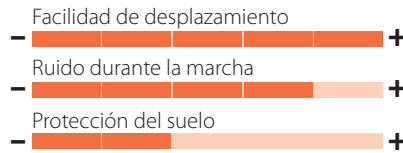

-20° a +60°

Dureza 65° shore D

Código						Tipo Cojinete Eje	Color	Anti-hilos Código Añadir
4-0023	80	200	34	12	40	—	Blanco	4-0284
2-2476	80	200	34	12	40	—	Blanco	4-1187
4-0046	80	200	34	12	40	—*	Blanco	-
4-0024	100	220	34	12	40	—	Blanco	4-0292
2-2455	100	220	34	12	40	—	Blanco	4-0292
4-0047	100	220	34	12	40	—*	Blanco	-
4-0025	125	250	35	12	40	—	Blanco	4-0293
2-2240	125	250	35	12	40	—	Blanco	4-0293
4-0048	125	250	35	12	40	—*	Blanco	-
2-1104	150	420	38	12	40	—	Blanco	-
2-4563	150	420	38	12	40	—	Blanco	-
2-0434	150	420	45	20	60	—	Blanco	2-0826
4-0027	200	500	50	20	60	—	Blanco	2-0827

*cojinete de rodillos inoxidable

Serie UTC

Rueda de poliamix negro
Conductiva



VENTAJAS DEL ARO

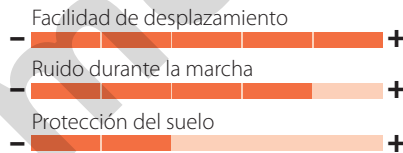

-40° a +300°

Dureza 65° shore D

NOVEDAD

Código						Tipo Cojinete Eje	Color	Anti-hilos Código Añadir
2-4532	80	200	34	12	40	—	Negro	-
2-4529	100	220	34	12	41	—	Negro	-
2-4533	125	250	35	12	40	—	Negro	-
2-4530	150	420	45	20	60	—	Negro	-
2-4531	200	500	50	20	60	—	Negro	-

Disponible con soporte, consultar.

Serie UTA

Rueda de poliamix blanco
(pisada balona)



VENTAJAS DEL ARO

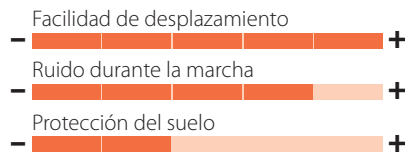

-20° a +60°

Dureza 65° shore D

Código	100	250	32	12	40	Tipo Cojinete Eje	Color	Anti-hilos Código Añadir
2-2806	100	250	32	12	40	—	Blanco	-

Serie TP

Rueda de poliamix blanco



VENTAJAS DEL ARO

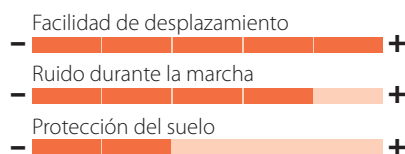

-20° a +60°

Dureza 65° shore D

Código	125	300	45	12	52	Tipo Cojinete Eje	Color	Anti-hilos Código Añadir
2-2478	125	300	45	12	52	—	Blanco	4-0293

Serie TA

Rueda de acero



VENTAJAS DEL ARO

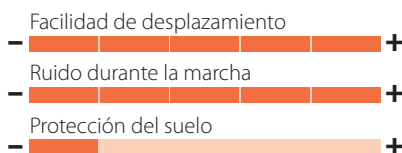

-90° a +600°

Dureza 95° HRB

Código						Tipo Cojinete Eje	Color	Anti-hilos Código Añadir
2-0072	80	300	34	12	41		Negro	-
2-0073	100	450	34	12	41		Negro	-
4-0556	100	450	40	20	45		Negro	-
2-0074	125	630	44	16	53		Negro	-
4-0558	125	630	40	20	50		Negro	-
4-0559	150	1.175	45	20	60		Negro	-
4-1648	150	1.175	45	25	60		Negro	-
4-0560	150	1.175	45	20	60		Negro	-
4-1649	150	1.175	45	25	60		Negro	-
4-0562	200	1.250	45	20	60		Negro	-
4-1650	200	1.250	45	25	60		Negro	-
4-0563	200	1.250	45	20	60		Negro	-
4-1651	200	1.250	45	25	60		Negro	-
4-0568	250	1.350	50	25	60		Negro	-

Las versiones con cojinetes de bolas, deben trabajar en un rango de temperatura: -40° a +150°

Para temperaturas superiores a 200° reducir carga (kg) un 40%

Serie TD

Rueda de resina



VENTAJAS DEL ARO

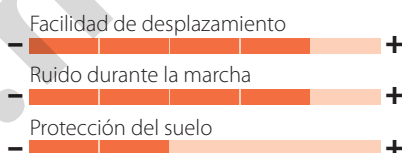

-40° a +200°

Dureza 75° shore D



Código						Tipo Cojinete Eje	Color	Anti-hilos Código Añadir
2-0063	80	280	28	12	41		Rojo	2-0816
2-0064	100	425	32	12	41		Rojo	4-1187
2-0065	125	550	37	16	52		Rojo	-
2-0066	150	750	42	20	60		Rojo	-
2-4002	200	900	50	20	60		Rojo	-

Serie TT

Rueda de resina

VENTAJAS DEL ARO

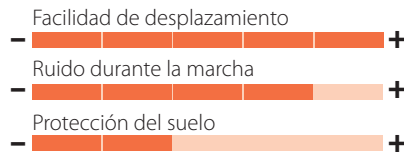

-30° a +280°

Dureza 90° shore D

*** AMPLIAMOS GAMA**



*
*

Código		KG				Tipo Cojinete Eje	Color	Anti-hilos Código Añadir
2-1052	80	100	34	12	41		Negro	2-0816
2-1053	100	125	34	12	41		Negro	4-1187
* 2-4521	100	125	34	15	41		Negro	-
* 2-4763	100	125	34	15	41	*	Negro	-

*cojinete de bolas inoxidable

Soporta temperaturas de hasta +280°C en intervalos de 30 min.

Serie THG

Goma negra

VENTAJAS DEL ARO

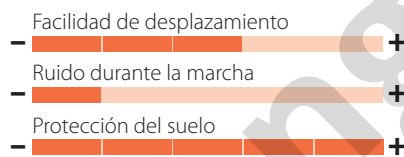

-30° a +250°

Dureza 80° shore A

NOVEDAD



Código		KG				Tipo Cojinete Eje	Color	Anti-hilos Código Añadir
2-4474	100	100	38	12	40		Negro	-

Soporta temperaturas de hasta +250°C en intervalos de 30 min.

Serie SLC

Rueda simil cristal



VENTAJAS DEL ARO

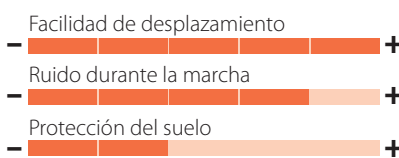

-20° a +60°

Dureza 80° shore D

Código						Tipo Cojinete Eje	Color	Anti-hilos Código Añadir
2-2166	60	60	24	10	27		Transparente	-
2-2168	80	70	22	10	27		Transparente	-
2-2169	100	80	22	10	27		Transparente	-

Serie BP gris

Rueda de polipropileno



VENTAJAS DEL ARO

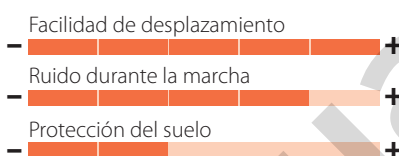

-20° a +60°

Dureza 65° shore D

Código						Tipo Cojinete Eje	Color	Anti-hilos Código Añadir
1-0416	30	20	15	4	18		Gris	-
1-0307	30	20	15	6	18		Gris	-
1-0415	40	30	17	5	20		Gris	-
1-0308	40	30	17	6	20		Gris	-
1-0439	50	40	17	6	19		Gris	-
1-0310	60	45	17	10	19		Gris	-

Serie BP blanco

Rueda de polipropileno



VENTAJAS DEL ARO

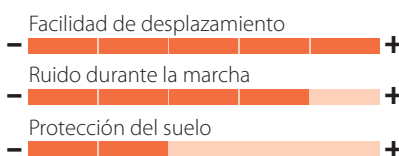

-20° a +60°

Dureza 65° shore D

Código						Tipo Cojinete Eje	Color	Anti-hilos Código Añadir
1-0414	40	30	17	5	20		Blanco	-
1-0317	50	40	17	10	20		Blanco	-
1-0318	60	60	24	10	27		Blanco	2-0820
2-1926	80	70	24	10	27		Blanco	2-1036
4-0021	100	80	25	10	27		Blanco	-

Serie KP

Rodillo de poliamix



VENTAJAS DEL ARO

- Facilidad de desplazamiento +
- Ruido durante la marcha +
- Protección del suelo +

-20° a +60°

Dureza 65° shore D

Código						Tipo Cojinete Eje	Color	Anti-hilos Código Añadir
1-0314	40	45	35	8	40	—	Blanco	-

Accesorios

Para hacer el pedido: al código de la rueda giratoria, fija o rueda suelta escogida, añadir el código del anti-hilos que corresponda;

Por ejemplo:

Rueda con horquilla: **código 2-0022 + código antihilo 2-0826**

Rueda suelta: **código 2-0070 + código antihilo 2-0826**



Antihilos

Rodillos para transpaletas



Serie VN

Núcleo metálico
y banda de poliuretano
vulcanizado

VENTAJAS DEL ARO

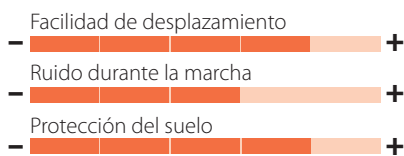

-20° a +60°

Dureza 95° shore A

*** AMPLIAMOS GAMA**



Código						Tipo Cojinete Eje	Color	Anti-hilos Código Añadir
* 2-4669	35	100	27	8	30		Naranja	-
2-1504	85	600	60	20	60		Naranja	-
2-1505	85	600	60	25	60		Naranja	-
* 2-4665	85	700	70	20	60		Naranja	-
* 2-4666	85	700	70	25	60		Naranja	-
2-3140	85	750	75	20	75		Naranja	-
2-3141	85	750	75	25	75		Naranja	-
2-1506	85	800	80	20	80		Naranja	-
2-1507	85	800	80	25	80		Naranja	-
2-1508	85	900	90	20	90		Naranja	-
2-1509	85	900	90	25	90		Naranja	-
2-1510	85	1.000	100	20	100		Naranja	-
2-1511	85	1.000	100	25	100		Naranja	-

Serie KI

Núcleo de nylon
y banda de poliuretano
inyectado

VENTAJAS DEL ARO

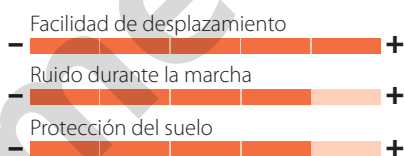

-25° a +80°

Dureza 95° shore A



Código						Tipo Cojinete Eje	Color	Anti-hilos Código Añadir
4-1538	82	450	60	20	60		Marrón	-
4-1539	82	450	60	25	60		Marrón	-
4-1540	82	500	70	20	70		Marrón	-
4-1541	82	500	70	25	70		Marrón	-
4-1542	82	550	80	20	80		Marrón	-
4-1543	82	550	80	25	80		Marrón	-
4-1544	82	650	90	20	90		Marrón	-
4-1545	82	650	90	25	90		Marrón	-
4-1546	82	750	100	20	100		Marrón	-
4-1547	82	750	100	25	100		Marrón	-

Rodillos para transpaletas



Serie KN

Rodillo de nylon
extrafuerte



VENTAJAS DEL ARO

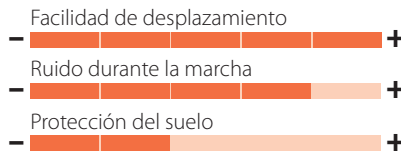

-30° a +80°

Dureza 75° shore D

* **AMPLIAMOS GAMA**

Código						Tipo Cojinete Eje	Color	Anti-hilos Código Añadir
4-1548	82	600	50	20	50		Blanco	-
4-1549	82	600	50	25	50		Blanco	-
4-1304	82	650	60	20	60		Blanco	-
4-1305	82	650	60	25	60		Blanco	-
4-1306	82	700	70	20	70		Blanco	-
4-1307	82	700	70	25	70		Blanco	-
* 4-1663	82	750	75	20	100		Blanco	-
* 4-1664	82	750	75	25	100		Blanco	-
4-1550	82	800	80	20	80		Blanco	-
4-1551	82	800	80	25	80		Blanco	-
4-1552	82	900	90	20	90		Blanco	-
4-1553	82	900	90	25	90		Blanco	-
4-1308	82	950	100	20	100		Blanco	-
4-1309	82	950	100	25	100		Blanco	-

Serie GR

Poliuretano



VENTAJAS DEL ARO

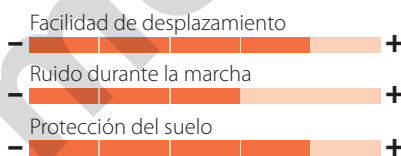

-30° a +80°

Dureza 92° shore A

NOVEDAD

Código						Tipo Cojinete Eje	Color	Anti-hilos Código Añadir
2-4659	30	20	11	8	11		Naranja	-
2-4660	40	30	15	10	15		Naranja	-
2-4661	50	60	20	12	20		Naranja	-
2-4662	60	70	20	17	20		Naranja	-
2-4663	70	75	25	20	25		Naranja	-
2-4664	85	80	25	20	25		Naranja	-



Ruedas

Twin-Lex

Producidas por la fábrica asociada de Ruedas Alex en China y bajo la supervisión de Ruedas Alex

ÍNDICE

- Serie **110 a** pág. 296
- Serie **805** pág. 321





DETALLES DEL PRODUCTO

- ✓ Fabricada con chapa de acero de gran resistencia.
- ✓ Acabado cincado brillante.
- ✓ Protector anti-polvo.
- ✓ Doble rodamiento a bolas.
- ✓ Diseñadas especialmente para: contenedores, cajas de herramientas, carritos de revistas, rollpalets.



280 - 300 kg	125 mm
---------------------	---------------

Medidas Generales

125	135x110	133x117	133x115	105x85/75	105x85/75	10	156	164	98

Aro serie 110

Polipropileno

280 kg



125



40

Cojinete Eje



Código

TW0022



280

Código

TW0023



280

Aro serie 111

Coma elástica

300 kg



125



50

Cojinete Eje



Código

TW0148



300

Código

TW0149



300



DETALLES DEL PRODUCTO

- ✓ Fabricada con chapa de acero forjado hasta 4 m/m de espesor.
- ✓ Acabado cincado brillante.
- ✓ Soporte embutido con doble hilera de bolas.
- ✓ Modelo de uso universal para cargas medias.
- ✓ Especialmente diseñado para: rollpalets, cajas de herramientas, carros para revistas y contenedores de transporte.

70 - 300 kg	80 a 200 mm
--------------------	--------------------

Medidas Generales

80	---	102x84	100x84	80x60/72x52	8	-	108	74
80		102x80	100x84	80x60/72x52	8	-	108	74
100	---	102x84	100x84	80x60/72x52	8	-	130	83
100		102x80	100x84	80x60/72x52	8	-	130	83
125	---	102x84	100x84	80x60/72x52	8	-	155	93
125		102x80	100x84	80x60/72x52	8	-	155	96
160	---	135x114	135x114	108x85/102x75	10	-	197	124
160		135x110	135x110	105x80	10	-	197	131
200	---	135x114	135x114	108x85/102x75	10	-	238	142
200		135x110	135x110	105x80	10	-	238	150

Aro serie 120

Goma negra

70 - 205 kg



Cojinete
Eje

80	25	
100	30	
125	37	
160	40	
200	50	

Código	KG
TW0024	70
TW0025	90
TW0026	120
TW0027	160
TW0028	205

Código	KG
TW0029	70
TW0030	90
TW0031	120
TW0032	160
TW0033	205

Código	KG
TW0034	70
TW0035	90
TW0036	120
TW0037	160
TW0038	205

Aro serie 121

Goma superelástica azul

80 - 300 kg



Cojinete
Eje

80	32	
100	32	
125	36	
160	50	
200	50	

Código	KG
* TW0293	80
TW0039	100
TW0125	130
* TW0296	250
* TW0299	300

Código	KG
* TW0294	80
TW0040	100
TW0126	130
* TW0297	250
* TW0300	300

Código	KG
* TW0295	80
TW0041	100
TW0127	130
* TW0298	250
* TW0301	300

Aros serie 123

Goma negra

60 - 200 kg



Cojinete
Eje

80	30	---
100	30	---
125	37	---
160	40	---
200	50	---

Código	KG
TW0253	60
TW0254	80
TW0255	110
TW0256	140
TW0257	200

Código	KG
TW0258	60
TW0259	80
TW0260	110
TW0261	140
TW0262	200

Código	KG
TW0263	60
TW0264	80
TW0265	110
TW0266	140
TW0267	200

Aros serie 124

Goma inyectada

80 - 140 kg



Cojinete
Eje

80	30	---
100	30	---
125	35	---
160	40	---
200	50	---

Código	KG
TW0220	80
TW0221	90
TW0222	110
* TW0302	130
* TW0305	140

Código	KG
TW0223	80
TW0224	90
TW0225	110
* TW0303	130
* TW0306	140

Código	KG
TW0226	80
TW0227	90
TW0228	110
* TW0304	130
* TW0307	140

Aros serie 125

Goma negra

70 - 205 kg



Cojinete
Eje

80	30	
100	30	
125	37	
160	40	
200	50	

Código	KG
TW0268	70
TW0269	90
TW0270	120
TW0271	160
TW0272	205

Código	KG
TW0273	70
TW0274	90
TW0275	120
TW0276	160
TW0277	205

Código	KG
TW0278	70
TW0279	90
TW0280	120
TW0281	160
TW0282	205

Aros serie 130

Poliamix

130 - 280 kg



Cojinete
Eje

80	30	
80	35	
100	30	
100	35	
125	35	
125	40	
160	40	
160	40	
200	45	
200	45	

Código	KG
TW0196	130
TW0042	130
TW0197	150
TW0043	150
TW0198	170
TW0044	170
TW0199	200
TW0045	200
TW0200	280
TW0046	280

Código	KG
TW0201	130
TW0047	130
TW0202	150
TW0048	150
TW0203	170
TW0049	170
TW0204	200
TW0050	200
TW0205	280
TW0051	280

Código	KG
TW0206	130
TW0052	130
TW0207	150
TW0053	150
TW0208	170
TW0054	170
TW0209	200
TW0055	200
TW0210	280
TW0056	280

Aros serie 140

Poliuretano

100 - 300 kg



Cojinete Eje

80	30	—
100	30	—
125	35	—
160	40	—
200	50	—

Código	KG
TW0211	100
TW0212	120
TW0213	150
* TW0308	250
* TW0311	300

Código	KG
TW0214	100
TW0215	120
TW0216	150
* TW0309	250
* TW0312	300

Código	KG
TW0217	100
TW0218	120
TW0219	150
* TW0310	250
* TW0313	300





DETALLES DEL PRODUCTO

- ✓ Acabado cincado brillante.
- ✓ Acabado cincado brillante.
- ✓ Tipo de fijación: espiga o cazoleta.
- ✓ Ruedas con rodamientos de bolas de precisión, eje macizo roscado y asegurado.
- ✓ Especialmente diseñado para andamios.
- ✓ Fijacion: Sistema estándar (Serie 200).

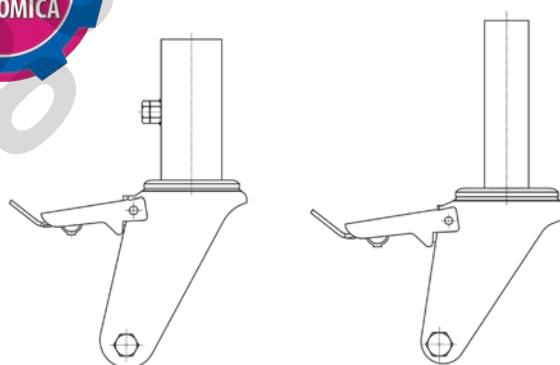

200 kg	200 mm
--------	--------

Medidas Generales

	SERIE 200		SERIE 201			
	CAZOLETA	ESPIGA	CAZOLETA	ESPIGA		
200	34x105	44x120	40x115	51x115	-	-

ARO 200 - ESTANDARD

Goma

200 kg

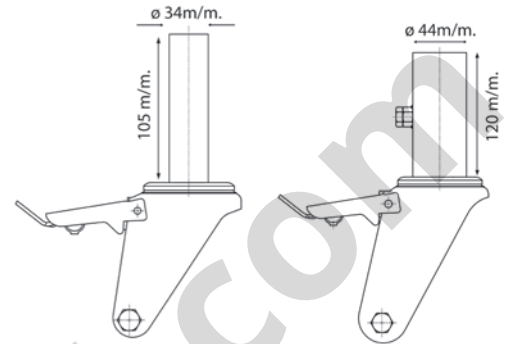

200



47

Cojinete
Eje

Código

TW0057



200

Código

TW0058



200

Serie 201

ARO 201 - EUROPEO

Goma

200 kg

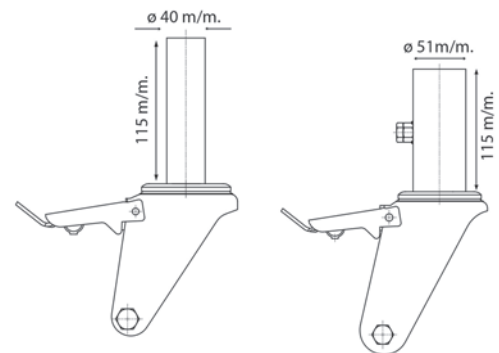

200



47

Cojinete
Eje

Código

TW0059



200

Código

TW0060



200



DETALLES DEL PRODUCTO

- ✓ Chapa de acero embutida.
- ✓ Tipo de fijación: pletina y agujero pasante.
- ✓ Acabado cincado brillante.
- ✓ Doble rodamiento a bolas.
- ✓ Especialmente diseñada para: pequeño mobiliario, expositores, mostradores y equipamiento comercial.



100 - 130 kg	100 a 150 mm
---------------------	---------------------

Medidas Generales

100	77x67	-	62x51/56x47	8	10	135	135
125	77x67	-	62x51/56x47	8	10	160	160
150	-	-	-	-	12	-	184

Aro serie 300

Goma inyectada

100 - 130 kg



Cojinete
Eje

100	32	
125	32	
150	32	

Código	KG
TW0061	100
TW0062	100
-	-

Código	KG
TW0063	100
TW0064	100
-	-

Código	KG
TW0065	100
TW0066	100
TW0249	130

Código	KG
TW0067	100
TW0068	100
TW0250	130

Aro serie 301

Goma inyectada

100 - 130 kg



Cojinete
Eje

100	32	
125	32	
150	32	

Código	KG
TW0069	100
TW0070	100
-	-

Código	KG
TW0071	100
TW0072	100
-	-

Código	KG
TW0073	100
TW0074	100
TW0251	130

Código	KG
TW0075	100
TW0076	100
TW0252	130



DETALLES DEL PRODUCTO

- ✓ Chapa de acero embutida.
- ✓ Tipo de fijación: pletina y agujero pasante.
- ✓ Acabado cincado brillante.
- ✓ Doble rodamiento a bolas.



25 - 80 kg	50 a 125 mm
------------	-------------

Medidas Generales



	GIRAT	FIJA				AGUJ	
50	50x50	-	39x39/32x32	6	10	70	69
75	65x65	-	52x52/44x44	6	10	105	99
100	76x76	-	60x60/50x50	8	12	130	129
125	76x76	-	60x60/50x50	8	12	160	157

Aro serie 310

Goma gris

25 - 80 kg



Cojinete
Eje

50	18	—
75	21	—
100	25	—
125	27	—

Código



TW0077	25
TW0079	50
TW0080	60
TW0081	80

Código



TW0082	25
TW0084	50
TW0085	60
TW0086	80

Código



TW0087	25
TW0089	50
TW0090	60
TW0091	80

Código



TW0092	25
TW0094	50
TW0095	60
TW0096	80



DETALLES DEL PRODUCTO

- ✓ Chapa de acero embutida.
- ✓ Tipo de fijación: pletina y agujero pasante.
- ✓ Acabado cincado brillante.
- ✓ Doble rodamiento a bolas.
- ✓ Especialmente diseñada para: pequeño mobiliario, expositores, mostradores y equipamiento comercial.



40 - 70 kg	50 a 100 mm
-------------------	--------------------

Medidas Generales



	GIRAT	FIJA				AGUJ	
50	60x60	60x60	46x46	6	10	72	51
60	60x60	60x67	46x46	6	10	82	52
80	60x60	60x67	46x46	6	10	104	68
100	60x60	60x67	46x46	6	10	121	80

Aro serie 400

Poliamida negra

50 - 70 kg



Cojinete
Eje

50	20	---
60	22	---
80	24	---
100	24	---

Código	KG
TW0136	50
TW0137	60
TW0138	65
TW0139	70

Código	KG
TW0140	50
TW0141	60
TW0142	65
TW0143	70

Código	KG
TW0097	50
TW0098	60
TW0099	65
TW0100	70

Código	KG
TW0144	50
TW0145	60
TW0146	65
TW0147	70

Aro serie 401

Goma gris

40 - 70 kg



Cojinete
Eje

50	20	---
60	24	---
80	24	---
100	24	---

Código	KG
TW0229	40
TW0230	50
TW0231	60
TW0232	70

Código	KG
TW0233	40
TW0234	50
TW0235	60
TW0236	70

Código	KG
TW0237	40
TW0238	50
TW0239	60
TW0240	70

40 - 70 kg



Cojinete
Eje

50	20	---
60	24	---
80	24	---
100	24	---

Código	KG
TW0241	40
TW0242	50
TW0243	60
TW0244	70

Código	KG
TW0245	40
TW0246	50
TW0247	60
TW0248	70









DETALLES DEL PRODUCTO

- ✓ Fabricada con chapa de acero hasta 2 m/m de espesor.
- ✓ Soporte con doble rodamiento a bolas.
- ✓ Acabado cincado brillante.
- ✓ Doble rodamiento a bolas.
- ✓ Especialmente diseñada para: mobiliario clínico, cámaras frigoríficas, mostradores, equipamiento y mobiliario informático.



 80 kg	 50 mm
---	---

Medidas Generales

								
50	60x60	-	47x47/40x40	6	10	72	72	-

Aro serie 410

Goma gris

80 kg



50



20x2

Cojinete Eje

Código



80

TW0101

Código



80

TW0103

Código



80

TW0105

Código



80

TW0107

Aro serie 411

Poliamida gris

80 kg



50



20x2

Cojinete Eje

Código



80

TW0102

Código



80

TW0104

Código



80

TW0106

Código



80

TW0108

415-416-417



DETALLES DEL PRODUCTO

- ✓ Soporte embutido con chapa de acero hasta 2 m/m de espesor.
- ✓ Soporte con doble rodamiento a bolas.
- ✓ Acabado cincado brillante.
- ✓ Especialmente diseñada para: pequeño mobiliario, equipamiento comercial, expositores, equipos de música.



10 - 45 kg	15 a 50 mm
------------	------------

Medidas Generales

Serie 415

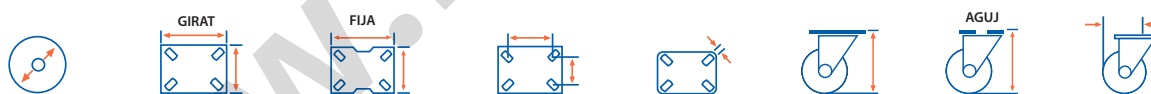

	GIRAT	FIJA				AGUJ	
25	38x32	38x19	30x24	30	35	-	26
30	38x32	38x19	30x24	30	40	-	30
40	46x38	46x24	36x28	36x15	50	-	34
50	60x47	60x42	45x35	42x25	65	-	50

Medidas Generales

Serie 416-417

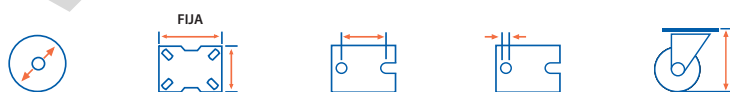

	FIJA			
15	30x16	21	4	17
25	40x20	30	4,5	28,5
30	46x19	34	5	35

Aro serie 415

Polipropileno

10- 30 kg



Cojinete
Eje

25	12	---
30	14	---
40	17	---
50	21	---

Código



TW0128	10
TW0129	18
TW0130	20
TW0131	30

Código



-	-
-	-
TW0134	20
TW0135	30

Código



TW0132	10
TW0133	18
-	-
-	-

Aro serie 416

Polipropileno

20- 45 kg

NOVEDAD



Cojinete
Eje

15	11	---
25	15	---
30	13	---

Código



TW0287	20
TW0288	40
TW0289	45

Aro serie 417

Goma gris

20- 45 kg

NOVEDAD



Cojinete
Eje

15	11	---
25	15	---
30	13	---

Código



TW0290	20
TW0291	40
TW0292	45



NOVEDAD

**GAMA
ECONÓMICA**

DETALLES DEL PRODUCTO

- ✓ Soporte de plástico para albergar las dos ruedas gemelas.
- ✓ Fijaciones: platina, espiga roscada, espiga con anilla y espiga lisa.
- ✓ Cubierta en negro.
- ✓ Especialmente diseñada para: muebles pequeños, sillas de oficina, expositores, pequeñas estanterías, armarios y estufas.

20 - 50 kg	40 a 50 mm
-------------------	-------------------

Medidas Generales

	GIRAT	FIJA		ROSC	LILA	ANILLA	PLAT	ROSC	LISA	ANILLA
40	38x38	25x25	5	6x15	-	-	53	50	-	-
50	38x38	25x25	5	8x15	8x26	11x22	62	63	62	61
50	-	-	-	10x15	-	-	-	63	-	-

Aro serie 420

Polipropileno negro

20 - 50 kg

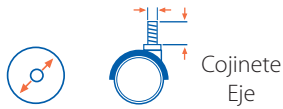

	Cojinete	Eje
40	6x15	—
50	8x15	—
50	10x15	—

Código	KG
TW0109	20
TW0110	50
-	-

Código	KG
TW0111	20
TW0112	50
-	-

Código	KG
TW0113	20
TW0114	50
TW0115	50

Código	KG
TW0116	20
TW0117	50
TW0118	50

20 - 50 kg

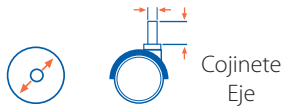
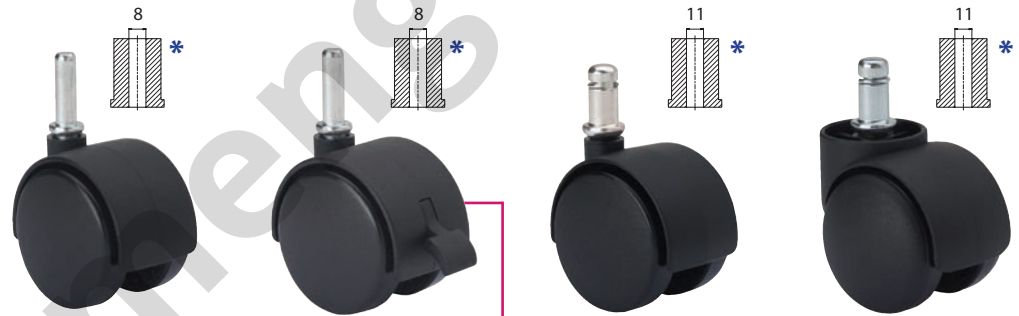

	Cojinete	Eje
40	-	—
50	8x26	—
50	11x22	—

Código	KG
-	-
TW0119	50
-	-

Código	KG
-	-
TW0286	50
-	-

Código	KG
-	-
-	-
TW0120	50

Código	KG
-	-
-	-
TW0121	50

*ver página 246

NOVEDAD

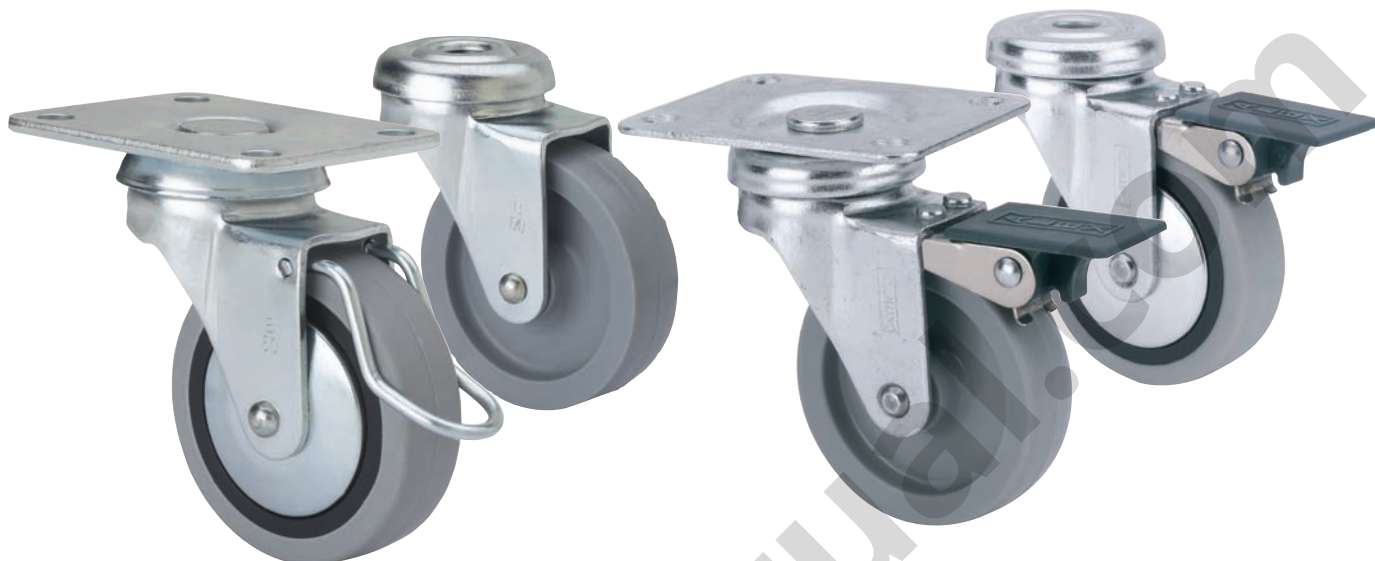

DETALLES DEL PRODUCTO

- ✓ Fabricada con chapa de acero hasta 2 m/m de espesor.
- ✓ Acabado cincado brillante.
- ✓ Ruedas de goma de 50 y 60 mm de diámetro con protectores incluidos de serie.
- ✓ Especialmente diseñada para: mobiliario clínico, cámaras frigoríficas, mostradores, equipamiento y mobiliario informático.



15 - 40 kg
 30 a 60 mm

Medidas Generales

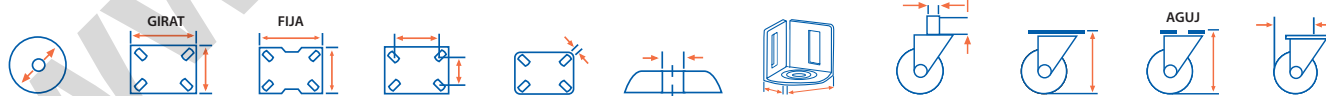

	GIRAT	FIJA							AGUJ	
30	46x36	-	34x24	5	8	-	-	51	48	32
40	46x36	-	34x24	5	8	-	-	58	57	45
50	70x55	-	54x38	6	10	-	-	72	67	46
60	70x55	-	54x38	6	10	-	-	81	78	53

Aro serie 601

Goma gris

15 - 25 kg



Cojinete
Eje

30	16	—
40	16	—
50	18	—
60	18	—

Código	KG
TW0150	15
TW0151	17
TW0152	22
TW0153	25

Código	KG
—	—
TW0158	17
TW0159	22
TW0160	25

Código	KG
—	—
—	—
—	—
TW0192	25

15 - 25 kg



Cojinete
Eje

30	16	—
40	16	—
50	18	—
60	18	—

Código	KG
TW0154	15
TW0155	17
TW0156	22
TW0157	25

Código	KG
—	—
TW0161	17
TW0162	22
TW0163	25

Código	KG
—	—
—	—
—	—
TW0193	25

Aro serie 602

Poliamix gris

15 - 40 kg



Cojinete
Eje

30	16	—
40	16	—
50	18	—
60	18	—

Código	KG
TW0164	15
TW0165	22
TW0166	35
TW0167	40

Código	KG
-	-
TW0172	22
TW0173	35
TW0174	40

Código	KG
-	-
-	-
-	-
TW0194	40

15 - 40 kg



Cojinete
Eje

30	16	—
40	16	—
50	18	—
60	18	—

Código	KG
TW0168	15
TW0169	22
TW0170	35
TW0171	40

Código	KG
-	-
TW0175	22
TW0176	35
TW0177	40

Código	KG
-	-
-	-
-	-
TW0195	40

800-801-802-804-805

Aro serie 800

Neumática - Llanta metálica

175 kg



Código	Serie						Tipo Cojinete Eje
TW0122	800	260	175	85	20	75	



Aro serie 801-802

Neumática - Llanta de plástico

175 kg



Código	Serie						Tipo Cojinete Eje
TW0123	801	260	175	85	20	75	
TW0124	802	260	175	85	20	75	



Aro serie 804-805

Impinchable - Llanta de plástico

175 kg



NOVEDAD



Código	Serie						Tipo Cojinete Eje
TW0284	804	260	175	85	20	75	
TW0285	804	260	175	85	20	75	



Índice de referencias

CÓDIGO	PÁGINA	CÓDIGO	PÁGINA	CÓDIGO	PÁGINA	CÓDIGO	PÁGINA
1-0014	231	1-0277	243	1-0368	246	1-0439	228
1-0017	231	1-0278	234	1-0369	246	1-0439	233
1-0021	223	1-0280	234	1-0370	246	1-0439	290
1-0023	234	1-0288	234	1-0371	246	1-0441	242
1-0024	234	1-0290	234	1-0372	246	1-0462	242
1-0115	195	1-0294	205	1-0373	246	1-0464	242
1-0118	243	1-0298	231	1-0374	246	1-0465	242
1-0119	243	1-0302	205	1-0375	246	1-0467	273
1-0120	243	1-0303	205	1-0376	246	1-0468	225
1-0121	243	1-0307	290	1-0377	246	1-0468	231
1-0122	243	1-0308	223	1-0378	246	1-0468	234
1-0123	243	1-0308	290	1-0379	246	1-0468	273
1-0125	242	1-0310	228	1-0380	246	1-0484	243
1-0127	242	1-0310	233	1-0381	246	1-0497	243
1-0129	242	1-0310	290	1-0382	246	1-0498	244
1-0130	242	1-0314	223	1-0383	246	1-0499	211
1-0141	195	1-0314	291	1-0384	246	1-0500	211
1-0163	205	1-0317	290	1-0385	246	1-0501	211
1-0166	208	1-0318	166	1-0386	205	1-0502	211
1-0170	205	1-0318	179	1-0387	205	1-0503	231
1-0171	233	1-0318	208	1-0388	205	1-0504	233
1-0172	233	1-0318	237	1-0390	214	1-0509	265
1-0173	233	1-0318	290	1-0391	214	1-0510	265
1-0174	208	1-0319	223	1-0394	242	1-0511	263
1-0176	205	1-0319	237	1-0395	213	1-0512	263
1-0177	208	1-0319	273	1-0396	213	1-0513	263
1-0178	231	1-0321	225	1-0397	213	1-0514	263
1-0179	205	1-0321	231	1-0398	213	1-0515	263
1-0180	205	1-0321	273	1-0399	225	1-0516	263
1-0181	208	1-0324	225	1-0399	231	1-0517	263
1-0190	231	1-0324	231	1-0399	273	1-0518	263
1-0214	231	1-0324	234	1-0400	231	1-0519	263
1-0215	231	1-0324	273	1-0401	246	1-0520	263
1-0216	231	1-0330	231	1-0404	242	1-0521	263
1-0217	231	1-0332	242	1-0405	242	1-0522	263
1-0218	231	1-0344	246	1-0406	242	1-0523	262
1-0221	208	1-0345	246	1-0408	244	1-0524	262
1-0222	208	1-0347	246	1-0409	244	1-0525	262
1-0223	231	1-0349	246	1-0410	244	1-0526	262
1-0225	233	1-0351	246	1-0411	246	1-0527	262
1-0228	233	1-0353	246	1-0412	246	1-0528	262
1-0231	231	1-0354	246	1-0413	246	1-0529	262
1-0237	235	1-0355	246	1-0414	237	1-0530	262
1-0238	235	1-0356	246	1-0414	290	1-0531	262
1-0239	242	1-0357	246	1-0415	228	1-0533	262
1-0240	242	1-0358	246	1-0415	233	1-0534	262
1-0241	242	1-0359	246	1-0415	235	1-0535	260
1-0242	242	1-0360	246	1-0415	290	1-0536	260
1-0262	223	1-0361	246	1-0416	233	1-0537	260
1-0265	223	1-0363	246	1-0416	235	1-0538	260
1-0273	223	1-0364	246	1-0416	290	1-0539	260
1-0274	223	1-0367	246	1-0439	223	1-0540	260

Índice de referencias

CÓDIGO	PÁGINA
1-0541	233
1-0542	233
1-0543	233
1-0544	233
1-0545	233
1-0546	233
1-0547	231
1-0548	231
1-0549	231
1-0550	231
1-0551	231
1-0552	231
1-0553	232
1-0554	232
1-0555	232
1-0556	232
1-0557	232
1-0558	232
1-0567	214
1-0568	214
1-0569	213
1-0570	213
1-0574	260
1-0575	260
1-0576	260
1-0578	260
1-0579	260
1-0580	260
1-0582	265
1-0583	265
1-0584	265
1-0586	265
1-0587	265
1-0588	265
1-0590	263
1-0591	263
1-0592	263
1-0593	263
1-0594	263
1-0595	263
1-0596	263
1-0597	263
1-0598	263
1-0599	263
1-0600	263
1-0601	263
1-0602	263
1-0603	263
1-0604	263
1-0605	263
1-0606	263
1-0607	263

CÓDIGO	PÁGINA
1-0608	263
1-0609	263
1-0610	263
1-0611	263
1-0612	263
1-0613	263
1-0614	266
1-0615	266
1-0616	266
1-0619	266
1-0620	266
1-0621	266
1-0622	266
1-0623	266
1-0624	266
1-0625	266
1-0626	267
1-0627	267
1-0628	267
1-0629	267
1-0630	267
1-0631	267
1-0632	267
1-0633	267
1-0634	267
1-0635	267
1-0636	267
1-0637	267
1-0642	244
1-0643	244
1-0644	244
1-0645	244
1-0646	244
1-0647	244
1-0648	246
1-0649	211
1-0650	211
1-0651	211
1-0652	211
1-0653	246
1-0654	246
1-0655	246
1-0656	246
1-0657	246
1-0658	246
1-0659	261
1-0660	261
1-0661	261
1-0662	261
1-0700	225
1-0701	225
1-0702	225

CÓDIGO	PÁGINA
1-0703	225
1-0704	225
1-0705	225
1-0706	225
1-0707	225
1-0708	225
1-0709	225
1-0710	225
1-0711	225
1-0712	225
1-0713	225
1-0715	228
1-0716	228
1-0717	228
1-0719	228
1-0720	228
1-0721	228
1-0722	228
1-0723	228
1-0724	228
1-0725	228
1-0726	228
1-0727	228
1-0728	227
1-0729	227
1-0730	227
1-0731	227
1-0732	227
1-0733	227
1-0734	227
1-0735	227
1-0736	227
1-0737	227
1-0738	227
1-0739	227
1-0740	227
1-0741	227
1-0742	226
1-0743	226
1-0744	226
1-0745	226
1-0746	226
1-0747	226
1-0748	226
1-0749	226
1-0750	226
1-0751	226
1-0752	226
1-0753	226
1-0754	226
1-0755	226
1-0756	219

CÓDIGO	PÁGINA
1-0757	219
1-0758	220
1-0759	220
1-0760	219
1-0761	219
1-0762	220
1-0763	220
1-0764	219
1-0765	219
1-0766	220
1-0767	220
1-0768	219
1-0769	219
1-0770	220
1-0771	220
1-0772	239
1-0773	239
1-0774	239
1-0775	240
1-0776	240
1-0777	240
1-0778	241
1-0779	261
1-0780	261
1-0781	261
1-0782	261
1-0783	261
1-0784	261
1-0785	219
1-0786	219
1-0787	243
1-0788	242
1-0789	242
1-0790	213
1-0791	213
1-0792	213
1-0793	213
1-0794	213
1-0795	213
2-0001	85
2-0002	85
2-0003	85
2-0004	85
2-0007	85
2-0008	85
2-0009	85
2-0010	85
2-0011	90
2-0012	90
2-0013	90
2-0014	90
2-0015	90

Índice de referencias

CÓDIGO	PÁGINA	CÓDIGO	PÁGINA	CÓDIGO	PÁGINA	CÓDIGO	PÁGINA
2-0016	90	2-0070	89	2-0232	109	2-0458	47
2-0017	90	2-0070	285	2-0233	109	2-0459	47
2-0018	90	2-0071	89	2-0234	109	2-0463	50
2-0019	89	2-0071	151	2-0235	132	2-0464	50
2-0020	89	2-0071	285	2-0236	132	2-0465	50
2-0021	89	2-0072	91	2-0237	132	2-0466	50
2-0022	89	2-0072	141	2-0238	132	2-0467	50
2-0023	89	2-0072	288	2-0239	132	2-0468	50
2-0024	89	2-0073	91	2-0240	132	2-0469	50
2-0025	89	2-0073	288	2-0241	132	2-0470	50
2-0026	89	2-0074	91	2-0242	132	2-0471	50
2-0027	89	2-0074	288	2-0243	132	2-0472	50
2-0028	91	2-0078	270	2-0244	132	2-0473	50
2-0029	91	2-0079	270	2-0245	109	2-0474	50
2-0030	91	2-0080	270	2-0248	109	2-0475	50
2-0031	91	2-0083	270	2-0259	184	2-0476	50
2-0032	91	2-0084	270	2-0260	184	2-0477	50
2-0033	91	2-0085	270	2-0265	184	2-0478	50
2-0034	91	2-0098	89	2-0267	184	2-0479	50
2-0035	91	2-0159	89	2-0295	203	2-0480	50
2-0039	214	2-0159	285	2-0303	86	2-0483	48
2-0040	214	2-0160	89	2-0304	86	2-0484	48
2-0041	237	2-0160	285	2-0305	86	2-0485	48
2-0042	237	2-0163	89	2-0306	86	2-0486	48
2-0045	237	2-0163	96	2-0307	86	2-0487	48
2-0046	237	2-0163	285	2-0308	86	2-0488	48
2-0059	85	2-0164	89	2-0309	86	2-0493	48
2-0059	276	2-0164	285	2-0310	86	2-0494	48
2-0060	85	2-0165	89	2-0311	86	2-0495	48
2-0060	276	2-0165	285	2-0312	86	2-0496	48
2-0061	85	2-0188	184	2-0313	86	2-0497	48
2-0061	95	2-0189	184	2-0314	86	2-0498	48
2-0061	276	2-0209	274	2-0315	86	2-0516	51
2-0062	85	2-0211	89	2-0316	86	2-0518	51
2-0062	276	2-0212	89	2-0317	86	2-0519	51
2-0063	90	2-0213	89	2-0318	86	2-0520	51
2-0063	170	2-0214	89	2-0326	203	2-0521	51
2-0063	288	2-0215	89	2-0368	274	2-0522	51
2-0064	90	2-0216	89	2-0369	274	2-0523	51
2-0064	170	2-0217	89	2-0411	109	2-0525	51
2-0064	288	2-0218	89	2-0411	271	2-0527	51
2-0065	90	2-0219	89	2-0412	109	2-0528	51
2-0065	288	2-0220	89	2-0412	271	2-0529	51
2-0066	90	2-0221	91	2-0434	133	2-0530	51
2-0066	170	2-0222	91	2-0434	166	2-0531	51
2-0066	288	2-0223	109	2-0434	286	2-0532	51
2-0067	89	2-0224	109	2-0449	47	2-0533	85
2-0067	285	2-0225	109	2-0450	47	2-0535	85
2-0068	89	2-0226	109	2-0451	47	2-0537	85
2-0068	285	2-0227	109	2-0452	47	2-0539	85
2-0069	89	2-0228	109	2-0453	47	2-0656	184
2-0069	285	2-0231	109	2-0454	47	2-0660	184

Índice de referencias

CÓDIGO	PÁGINA
2-0784	112
2-0784	113
2-0784	156
2-0784	156
2-0784	156
2-0784	184
2-0784	203
2-0784	272
2-0785	85
2-0785	95
2-0785	276
2-0786	85
2-0786	276
2-0787	177
2-0787	205
2-0787	273
2-0790	112
2-0790	113
2-0790	156
2-0790	156
2-0790	156
2-0790	184
2-0790	272
2-0799	275
2-0806	177
2-0806	203
2-0806	205
2-0806	273
2-0807	112
2-0807	113
2-0807	184
2-0807	272
2-0848	110
2-0848	155
2-0848	155
2-0848	276
2-0849	110
2-0849	155
2-0849	155
2-0849	276
2-0850	110
2-0850	155
2-0850	155
2-0850	276
2-0851	110
2-0851	276
2-0852	110
2-0852	155
2-0852	155
2-0852	276
2-0853	110
2-0853	155

CÓDIGO	PÁGINA
2-0853	155
2-0853	276
2-0857	110
2-0858	110
2-0860	110
2-0864	110
2-0865	110
2-0867	110
2-0868	110
2-0870	110
2-0874	110
2-0875	110
2-0903	151
2-0905	151
2-0906	151
2-0915	151
2-0917	151
2-0918	151
2-0947	89
2-0948	89
2-0949	132
2-0950	132
2-0952	109
2-0955	109
2-0957	110
2-0958	110
2-0960	91
2-0966	86
2-0967	86
2-0983	47
2-0984	47
2-0999	110
2-1000	109
2-1001	132
2-1002	110
2-1003	109
2-1004	132
2-1005	95
2-1014	95
2-1015	95
2-1024	109
2-1026	133
2-1027	110
2-1028	250
2-1034	237
2-1035	237
2-1037	186
2-1037	130
2-1037	203
2-1037	283
2-1038	203
2-1039	186

CÓDIGO	PÁGINA
2-1040	186
2-1041	186
2-1042	186
2-1043	186
2-1044	203
2-1052	90
2-1052	170
2-1052	289
2-1053	90
2-1053	134
2-1053	170
2-1053	289
2-1056	90
2-1057	90
2-1058	90
2-1059	90
2-1064	156
2-1064	177
2-1064	205
2-1064	237
2-1064	273
2-1071	110
2-1072	110
2-1073	110
2-1074	110
2-1075	110
2-1088	134
2-1089	134
2-1090	134
2-1091	134
2-1092	134
2-1093	134
2-1094	134
2-1095	134
2-1096	134
2-1097	134
2-1098	134
2-1099	134
2-1100	186
2-1100	130
2-1100	203
2-1100	283
2-1101	186
2-1102	186
2-1103	186
2-1104	133
2-1104	286
2-1106	251
2-1107	251
2-1108	249
2-1109	249
2-1110	249

CÓDIGO	PÁGINA
2-1111	249
2-1112	249
2-1113	249
2-1114	90
2-1114	134
2-1115	110
2-1116	251
2-1117	249
2-1118	249
2-1119	249
2-1122	110
2-1122	276
2-1123	110
2-1123	276
2-1124	112
2-1124	113
2-1124	184
2-1124	272
2-1125	112
2-1125	113
2-1125	184
2-1125	272
2-1126	184
2-1127	184
2-1129	184
2-1130	184
2-1131	184
2-1132	184
2-1133	184
2-1135	184
2-1136	203
2-1137	203
2-1146	120
2-1146	183
2-1146	203
2-1146	273
2-1149	109
2-1150	109
2-1151	110
2-1153	110
2-1155	107
2-1157	107
2-1158	107
2-1162	166
2-1163	166
2-1164	166
2-1165	166
2-1166	166
2-1167	166
2-1168	166
2-1169	166
2-1170	160

Índice de referencias

CÓDIGO	PÁGINA	CÓDIGO	PÁGINA	CÓDIGO	PÁGINA	CÓDIGO	PÁGINA
2-1171	160	2-1256	85	2-1381	134	2-1477	170
2-1174	160	2-1257	85	2-1382	134	2-1482	111
2-1175	160	2-1312	112	2-1383	134	2-1483	111
2-1176	160	2-1312	113	2-1384	134	2-1486	184
2-1177	160	2-1312	156	2-1385	134	2-1488	208
2-1178	170	2-1312	156	2-1385	134	2-1489	205
2-1179	170	2-1312	184	2-1388	109	2-1489	205
2-1180	170	2-1312	272	2-1389	109	2-1491	205
2-1181	170	2-1313	107	2-1390	109	2-1491	205
2-1182	156	2-1314	166	2-1391	109	2-1492	205
2-1183	156	2-1315	166	2-1394	109	2-1492	205
2-1184	156	2-1319	156	2-1396	109	2-1494	233
2-1185	156	2-1320	156	2-1398	109	2-1495	233
2-1186	155	2-1321	170	2-1401	109	2-1504	76
2-1187	155	2-1322	170	2-1404	156	2-1504	292
2-1188	155	2-1323	170	2-1405	156	2-1505	292
2-1189	155	2-1324	170	2-1406	156	2-1506	292
2-1190	107	2-1325	166	2-1407	155	2-1507	292
2-1192	107	2-1326	166	2-1408	155	2-1508	292
2-1193	107	2-1327	156	2-1410	161	2-1509	292
2-1194	132	2-1328	156	2-1411	161	2-1510	292
2-1195	132	2-1338	110	2-1412	167	2-1511	292
2-1208	184	2-1339	110	2-1413	167	2-1512	50
2-1209	184	2-1341	110	2-1414	167	2-1513	50
2-1210	184	2-1343	110	2-1415	167	2-1514	50
2-1211	184	2-1346	110	2-1416	167	2-1518	47
2-1216	186	2-1347	110	2-1417	170	2-1521	50
2-1217	186	2-1348	110	2-1418	170	2-1525	47
2-1226	85	2-1349	110	2-1419	170	2-1526	47
2-1226	276	2-1351	110	2-1420	170	2-1528	48
2-1227	184	2-1353	110	2-1421	184	2-1529	48
2-1229	184	2-1354	110	2-1422	184	2-1530	48
2-1230	184	2-1355	110	2-1423	184	2-1531	48
2-1231	184	2-1356	110	2-1424	184	2-1538	48
2-1233	184	2-1357	107	2-1425	184	2-1540	51
2-1234	184	2-1359	107	2-1432	191	2-1541	51
2-1235	184	2-1361	107	2-1433	191	2-1542	51
2-1237	184	2-1362	107	2-1434	189	2-1543	51
2-1238	184	2-1363	107	2-1435	189	2-1544	51
2-1240	184	2-1365	107	2-1436	189	2-1565	184
2-1251	85	2-1366	107	2-1437	189	2-1566	184
2-1251	276	2-1368	133	2-1442	47	2-1567	184
2-1252	112	2-1369	133	2-1443	86	2-1568	184
2-1252	113	2-1370	133	2-1443	125	2-1569	184
2-1252	184	2-1371	133	2-1443	160	2-1569	272
2-1252	272	2-1373	133	2-1443	161	2-1574	91
2-1253	112	2-1374	109	2-1443	281	2-1575	237
2-1253	113	2-1375	133	2-1453	47	2-1576	237
2-1253	184	2-1376	133	2-1473	107	2-1577	237
2-1253	272	2-1377	133	2-1474	161	2-1578	185
2-1254	85	2-1378	133	2-1475	170	2-1579	185
2-1255	85	2-1380	134	2-1476	170	2-1580	185

Índice de referencias

CÓDIGO	PÁGINA	CÓDIGO	PÁGINA	CÓDIGO	PÁGINA	CÓDIGO	PÁGINA
2-1581	185	2-1632	85	2-1721	166	2-1807	89
2-1585	185	2-1633	86	2-1722	160	2-1808	89
2-1586	185	2-1634	86	2-1723	160	2-1809	89
2-1587	185	2-1635	89	2-1724	156	2-1810	89
2-1588	185	2-1636	89	2-1725	156	2-1811	89
2-1589	185	2-1637	90	2-1746	82	2-1812	89
2-1590	185	2-1639	91	2-1746	140	2-1813	89
2-1591	185	2-1642	166	2-1746	278	2-1814	89
2-1592	185	2-1643	166	2-1747	82	2-1817	89
2-1593	185	2-1644	166	2-1747	87	2-1818	89
2-1594	185	2-1645	166	2-1747	140	2-1819	50
2-1595	185	2-1648	167	2-1747	278	2-1819	89
2-1599	185	2-1649	167	2-1748	87	2-1820	50
2-1600	185	2-1650	167	2-1748	59	2-1820	89
2-1601	185	2-1651	167	2-1748	64	2-1821	89
2-1602	131	2-1652	160	2-1748	73	2-1822	89
2-1602	185	2-1654	160	2-1748	82	2-1823	89
2-1602	283	2-1654	160	2-1748	140	2-1824	89
2-1603	131	2-1655	160	2-1748	278	2-1825	89
2-1603	185	2-1655	160	2-1749	59	2-1828	89
2-1603	283	2-1656	161	2-1749	64	2-1829	89
2-1604	131	2-1658	161	2-1749	73	2-1830	156
2-1604	185	2-1659	161	2-1749	82	2-1831	161
2-1604	283	2-1662	156	2-1749	87	2-1832	167
2-1605	131	2-1663	156	2-1749	278	2-1833	170
2-1605	185	2-1664	134	2-1750	54	2-1834	170
2-1605	283	2-1666	156	2-1750	64	2-1835	156
2-1606	85	2-1667	156	2-1750	278	2-1836	156
2-1607	85	2-1669	155	2-1751	48	2-1837	166
2-1608	85	2-1670	155	2-1752	48	2-1838	167
2-1609	85	2-1671	155	2-1753	48	2-1839	160
2-1610	85	2-1672	155	2-1754	48	2-1840	161
2-1611	85	2-1673	155	2-1755	48	2-1841	155
2-1612	86	2-1674	155	2-1756	48	2-1842	87
2-1613	86	2-1675	155	2-1757	48	2-1843	155
2-1614	86	2-1676	155	2-1758	48	2-1844	87
2-1615	86	2-1677	155	2-1759	48	2-1845	87
2-1616	89	2-1679	155	2-1760	48	2-1846	87
2-1617	89	2-1680	155	2-1761	48	2-1853	43
2-1618	89	2-1682	155	2-1762	48	2-1854	43
2-1619	89	2-1683	155	2-1763	48	2-1855	43
2-1620	89	2-1684	155	2-1763	48	2-1856	43
2-1621	89	2-1685	155	2-1788	87	2-1857	43
2-1622	90	2-1686	155	2-1789	87	2-1858	43
2-1623	90	2-1687	155	2-1797	89	2-1865	43
2-1624	90	2-1688	134	2-1798	89	2-1866	43
2-1625	90	2-1689	134	2-1799	89	2-1867	43
2-1626	90	2-1716	170	2-1800	89	2-1868	43
2-1628	91	2-1717	170	2-1801	89	2-1869	43
2-1629	91	2-1718	170	2-1802	89	2-1870	43
2-1630	91	2-1719	170	2-1803	89	2-1871	44
2-1631	85	2-1720	166	2-1806	89	2-1872	44

Índice de referencias

CÓDIGO	PÁGINA	CÓDIGO	PÁGINA	CÓDIGO	PÁGINA	CÓDIGO	PÁGINA
2-1873	44	2-1961	47	2-2033	125	2-2239	133
2-1874	44	2-1968	63	2-2034	125	2-2240	133
2-1875	44	2-1969	63	2-2035	125	2-2240	286
2-1876	44	2-1970	63	2-2046	86	2-2269	96
2-1877	44	2-1971	63	2-2047	86	2-2274	264
2-1878	44	2-1972	63	2-2048	86	2-2275	264
2-1879	44	2-1973	63	2-2049	86	2-2276	264
2-1880	44	2-1982	81	2-2050	86	2-2277	264
2-1881	44	2-1983	81	2-2051	86	2-2278	264
2-1882	44	2-1986	81	2-2052	86	2-2279	264
2-1883	44	2-1987	81	2-2053	86	2-2280	264
2-1884	44	2-1992	85	2-2054	86	2-2281	264
2-1885	44	2-1993	85	2-2055	87	2-2282	264
2-1886	44	2-1994	85	2-2056	87	2-2283	264
2-1887	44	2-1995	85	2-2057	87	2-2284	96
2-1888	44	2-1996	85	2-2143	264	2-2285	47
2-1889	44	2-1997	85	2-2144	264	2-2286	47
2-1890	44	2-1998	85	2-2145	264	2-2287	47
2-1891	44	2-1999	85	2-2147	264	2-2289	47
2-1892	44	2-2000	85	2-2148	264	2-2291	47
2-1898	155	2-2001	130	2-2150	264	2-2293	47
2-1899	155	2-2002	130	2-2151	264	2-2294	48
2-1900	155	2-2003	130	2-2166	264	2-2295	48
2-1901	132	2-2004	125	2-2166	290	2-2296	48
2-1903	133	2-2005	125	2-2168	264	2-2297	50
2-1905	110	2-2006	125	2-2168	290	2-2298	50
2-1906	110	2-2007	125	2-2169	264	2-2299	50
2-1908	109	2-2008	130	2-2169	290	2-2301	50
2-1910	109	2-2009	130	2-2181	215	2-2302	50
2-1911	208	2-2010	130	2-2182	215	2-2303	51
2-1912	208	2-2011	125	2-2183	215	2-2304	51
2-1913	208	2-2012	125	2-2185	215	2-2305	51
2-1914	208	2-2013	125	2-2186	215	2-2306	110
2-1915	208	2-2014	125	2-2187	189	2-2307	110
2-1916	208	2-2015	130	2-2188	189	2-2309	109
2-1917	191	2-2016	130	2-2189	189	2-2311	109
2-1918	191	2-2017	130	2-2190	189	2-2314	125
2-1919	208	2-2018	125	2-2193	85	2-2315	125
2-1920	208	2-2019	125	2-2194	85	2-2318	125
2-1921	208	2-2020	125	2-2195	85	2-2319	125
2-1922	208	2-2021	125	2-2201	215	2-2322	125
2-1926	179	2-2022	130	2-2202	215	2-2323	125
2-1926	208	2-2023	130	2-2203	215	2-2326	125
2-1926	290	2-2024	130	2-2204	215	2-2327	125
2-1951	47	2-2025	125	2-2205	215	2-2330	125
2-1952	47	2-2026	125	2-2206	215	2-2331	125
2-1953	47	2-2027	125	2-2207	215	2-2332	132
2-1956	47	2-2028	125	2-2234	215	2-2333	132
2-1957	47	2-2029	130	2-2235	132	2-2334	132
2-1958	47	2-2030	130	2-2236	132	2-2336	132
2-1959	47	2-2031	130	2-2237	132	2-2337	132
2-1960	47	2-2032	125	2-2238	133	2-2338	132

Índice de referencias

CÓDIGO	PÁGINA	CÓDIGO	PÁGINA	CÓDIGO	PÁGINA	CÓDIGO	PÁGINA
2-2339	155	2-2402	113	2-2461	207	2-2497	147
2-2340	132	2-2403	113	2-2462	207	2-2500	127
2-2341	132	2-2404	113	2-2463	191	2-2500	162
2-2342	132	2-2405	113	2-2464	207	2-2500	163
2-2343	132	2-2406	113	2-2465	207	2-2500	173
2-2344	155	2-2407	113	2-2466	191	2-2500	281
2-2345	133	2-2408	113	2-2467	207	2-2501	112
2-2346	133	2-2409	113	2-2468	207	2-2504	113
2-2347	133	2-2410	113	2-2469	191	2-2505	113
2-2348	156	2-2411	113	2-2470	207	2-2506	135
2-2349	133	2-2412	113	2-2471	207	2-2507	135
2-2350	133	2-2413	113	2-2472	191	2-2508	135
2-2351	133	2-2414	166	2-2473	207	2-2509	135
2-2352	133	2-2415	167	2-2474	207	2-2510	135
2-2353	156	2-2416	162	2-2475	178	2-2511	135
2-2354	126	2-2417	162	2-2475	207	2-2512	135
2-2355	126	2-2418	162	2-2475	283	2-2513	135
2-2356	126	2-2419	162	2-2476	133	2-2514	135
2-2357	126	2-2420	162	2-2476	286	2-2515	135
2-2358	126	2-2421	162	2-2477	178	2-2516	135
2-2359	126	2-2422	162	2-2477	207	2-2517	135
2-2360	126	2-2423	162	2-2477	283	2-2518	135
2-2361	126	2-2424	162	2-2478	96	2-2519	135
2-2362	126	2-2425	162	2-2478	287	2-2520	135
2-2363	126	2-2426	162	2-2480	127	2-2521	162
2-2363	126	2-2427	162	2-2480	127	2-2521	178
2-2364	126	2-2428	162	2-2480	162	2-2521	207
2-2365	126	2-2429	162	2-2480	163	2-2521	283
2-2366	126	2-2430	162	2-2480	173	2-2522	207
2-2367	126	2-2431	162	2-2480	281	2-2522	207
2-2368	126	2-2432	162	2-2481	127	2-2525	207
2-2369	126	2-2433	162	2-2481	127	2-2526	121
2-2370	126	2-2434	163	2-2481	162	2-2527	121
2-2371	126	2-2435	163	2-2481	163	2-2528	121
2-2372	127	2-2436	163	2-2481	173	2-2529	121
2-2373	127	2-2437	163	2-2481	281	2-2530	121
2-2374	127	2-2438	163	2-2482	127	2-2531	121
2-2375	127	2-2439	163	2-2482	162	2-2532	121
2-2376	127	2-2440	163	2-2482	163	2-2533	121
2-2377	127	2-2441	163	2-2482	281	2-2534	121
2-2384	112	2-2442	163	2-2483	127	2-2535	121
2-2385	112	2-2443	163	2-2483	162	2-2536	121
2-2386	112	2-2444	163	2-2483	163	2-2537	121
2-2387	112	2-2444	163	2-2483	163	2-2538	121
2-2388	112	2-2450	96	2-2483	281	2-2539	121
2-2389	112	2-2451	96	2-2484	112	2-2540	121
2-2390	112	2-2455	133	2-2485	112	2-2541	121
2-2391	112	2-2455	286	2-2486	112	2-2542	121
2-2392	112	2-2456	283	2-2492	113	2-2543	121
2-2393	112	2-2457	208	2-2493	113	2-2544	121
2-2394	112	2-2458	208	2-2494	147	2-2545	121
2-2395	112	2-2459	205	2-2495	147	2-2546	121
		2-2460	205	2-2496	147	2-2546	279

Índice de referencias

CÓDIGO	PÁGINA	CÓDIGO	PÁGINA	CÓDIGO	PÁGINA	CÓDIGO	PÁGINA
2-2547	121	2-2690	168	2-2750	115	2-2815	206
2-2547	279	2-2691	168	2-2752	115	2-2816	206
2-2548	88	2-2692	168	2-2753	115	2-2817	206
2-2548	121	2-2693	168	2-2754	115	2-2818	206
2-2548	279	2-2694	168	2-2755	115	2-2819	206
2-2549	88	2-2695	168	2-2755	115	2-2820	128
2-2549	121	2-2696	168	2-2755	271	2-2821	128
2-2549	279	2-2697	168	2-2756	115	2-2822	128
2-2550	121	2-2698	168	2-2756	271	2-2823	129
2-2550	279	2-2699	168	2-2757	115	2-2824	129
2-2558	226	2-2700	169	2-2757	271	2-2825	128
2-2558	232	2-2701	169	2-2758	115	2-2826	128
2-2558	283	2-2702	169	2-2758	271	2-2827	128
2-2559	226	2-2703	169	2-2759	120	2-2828	129
2-2559	232	2-2704	169	2-2759	183	2-2829	129
2-2559	283	2-2705	169	2-2759	203	2-2830	128
2-2560	226	2-2706	169	2-2759	273	2-2831	128
2-2560	232	2-2707	169	2-2771	215	2-2832	128
2-2560	283	2-2708	169	2-2772	166	2-2833	129
2-2561	226	2-2709	169	2-2773	166	2-2834	129
2-2561	232	2-2710	169	2-2774	166	2-2835	128
2-2561	283	2-2711	169	2-2775	166	2-2836	128
2-2563	232	2-2712	183	2-2776	166	2-2837	128
2-2564	232	2-2713	183	2-2777	166	2-2837	128
2-2565	232	2-2714	183	2-2778	166	2-2838	129
2-2566	232	2-2715	183	2-2779	166	2-2839	129
2-2569	232	2-2716	183	2-2780	166	2-2840	128
2-2570	232	2-2719	189	2-2781	166	2-2841	128
2-2571	232	2-2720	189	2-2782	166	2-2842	128
2-2572	232	2-2721	189	2-2783	166	2-2843	129
2-2573	232	2-2722	189	2-2789	215	2-2844	129
2-2576	232	2-2723	114	2-2790	215	2-2845	128
2-2633	162	2-2725	114	2-2791	215	2-2846	128
2-2634	162	2-2726	114	2-2792	107	2-2847	128
2-2666	183	2-2727	114	2-2793	107	2-2848	129
2-2667	183	2-2728	114	2-2794	107	2-2849	129
2-2668	183	2-2729	114	2-2795	107	2-2850	129
2-2669	183	2-2731	114	2-2796	107	2-2850	164
2-2670	183	2-2732	114	2-2798	167	2-2850	165
2-2674	96	2-2733	114	2-2799	167	2-2850	282
2-2678	107	2-2734	114	2-2800	167	2-2851	129
2-2679	107	2-2735	114	2-2801	167	2-2851	164
2-2680	121	2-2737	114	2-2802	167	2-2851	165
2-2681	121	2-2738	114	2-2803	167	2-2851	282
2-2682	168	2-2739	114	2-2804	167	2-2852	129
2-2683	168	2-2740	114	2-2805	167	2-2852	129
2-2684	168	2-2741	115	2-2806	287	2-2852	164
2-2685	168	2-2743	115	2-2810	206	2-2852	165
2-2686	168	2-2745	115	2-2811	206	2-2852	282
2-2687	168	2-2746	115	2-2812	206	2-2853	129
2-2688	168	2-2747	115	2-2813	206	2-2853	164
2-2689	168	2-2748	115	2-2814	206	2-2853	165

Índice de referencias

CÓDIGO	PÁGINA	CÓDIGO	PÁGINA	CÓDIGO	PÁGINA	CÓDIGO	PÁGINA
2-2853	282	2-2901	126	2-2955	165	2-3054	178
2-2854	129	2-2902	126	2-2956	165	2-3059	179
2-2854	164	2-2903	126	2-2957	165	2-3060	179
2-2854	165	2-2904	126	2-2958	165	2-3061	179
2-2854	282	2-2904	126	2-2959	127	2-3062	179
2-2855	164	2-2905	126	2-2959	281	2-3063	179
2-2856	164	2-2906	126	2-2960	127	2-3064	179
2-2857	164	2-2907	126	2-2960	127	2-3065	179
2-2858	165	2-2908	127	2-2960	281	2-3066	179
2-2859	165	2-2909	127	2-2961	127	2-3067	179
2-2860	164	2-2910	127	2-2961	281	2-3068	179
2-2862	164	2-2914	128	2-2962	129	2-3077	174
2-2863	165	2-2915	128	2-2962	282	2-3078	174
2-2864	165	2-2916	128	2-2963	129	2-3079	174
2-2865	164	2-2917	128	2-2963	282	2-3080	174
2-2866	164	2-2918	128	2-2964	129	2-3081	174
2-2867	164	2-2919	128	2-2964	129	2-3082	174
2-2868	165	2-2920	128	2-2964	282	2-3083	174
2-2869	165	2-2921	128	2-2965	126	2-3084	174
2-2870	164	2-2922	128	2-2966	126	2-3085	174
2-2871	164	2-2923	129	2-2967	126	2-3086	174
2-2872	164	2-2924	129	2-2968	127	2-3087	174
2-2873	165	2-2925	129	2-2970	128	2-3088	174
2-2874	165	2-2926	129	2-2971	128	2-3089	174
2-2875	164	2-2927	129	2-2972	128	2-3090	174
2-2876	164	2-2928	129	2-2973	129	2-3091	174
2-2877	164	2-2929	162	2-2974	129	2-3092	173
2-2878	165	2-2930	162	2-2975	162	2-3093	173
2-2879	165	2-2931	162	2-2976	162	2-3094	173
2-2880	164	2-2932	162	2-2977	162	2-3095	173
2-2881	164	2-2933	162	2-2978	163	2-3096	173
2-2882	164	2-2934	162	2-2979	163	2-3097	173
2-2883	165	2-2935	162	2-2980	164	2-3098	173
2-2884	165	2-2936	162	2-2981	164	2-3099	173
2-2885	110	2-2937	162	2-2982	164	2-3100	173
2-2886	110	2-2938	163	2-2983	165	2-3101	173
2-2887	110	2-2939	163	2-2984	165	2-3102	173
2-2888	110	2-2940	163	2-3039	177	2-3103	173
2-2889	110	2-2941	163	2-3040	177	2-3104	173
2-2890	243	2-2942	163	2-3041	177	2-3105	173
2-2891	206	2-2943	163	2-3042	177	2-3106	173
2-2891	273	2-2944	164	2-3043	177	2-3137	203
2-2892	206	2-2945	164	2-3044	177	2-3140	292
2-2892	273	2-2946	164	2-3045	177	2-3141	292
2-2893	96	2-2947	164	2-3046	177	2-3142	119
2-2894	91	2-2948	164	2-3047	177	2-3142	159
2-2895	91	2-2949	164	2-3048	177	2-3142	159
2-2896	91	2-2950	164	2-3049	178	2-3142	275
2-2897	91	2-2951	164	2-3050	178	2-3143	119
2-2898	91	2-2952	164	2-3051	178	2-3143	119
2-2899	126	2-2953	165	2-3052	178	2-3143	159
2-2900	126	2-2954	165	2-3053	178	2-3143	275

Índice de referencias

CÓDIGO	PÁGINA	CÓDIGO	PÁGINA	CÓDIGO	PÁGINA	CÓDIGO	PÁGINA
2-3144	119	2-3210	118	2-3262	158	2-3312	159
2-3144	159	2-3211	118	2-3263	158	2-3312	275
2-3144	275	2-3212	118	2-3264	158	2-3313	76
2-3145	119	2-3213	118	2-3265	158	2-3313	87
2-3145	159	2-3214	118	2-3266	158	2-3313	279
2-3145	275	2-3215	118	2-3267	158	2-3314	76
2-3146	119	2-3216	118	2-3268	158	2-3314	87
2-3146	159	2-3217	118	2-3269	158	2-3314	279
2-3146	275	2-3218	118	2-3270	158	2-3315	199
2-3147	119	2-3219	118	2-3271	158	2-3316	199
2-3147	275	2-3220	118	2-3272	158	2-3317	199
2-3148	119	2-3221	118	2-3273	158	2-3318	199
2-3148	275	2-3222	118	2-3274	158	2-3319	199
2-3149	119	2-3223	118	2-3275	158	2-3320	199
2-3149	275	2-3224	118	2-3276	158	2-3321	199
2-3178	53	2-3225	118	2-3277	158	2-3322	199
2-3179	54	2-3226	118	2-3278	158	2-3323	199
2-3180	54	2-3227	118	2-3279	158	2-3324	199
2-3181	55	2-3228	118	2-3280	158	2-3325	199
2-3182	53	2-3229	118	2-3281	158	2-3326	199
2-3183	54	2-3230	118	2-3282	158	2-3327	107
2-3184	54	2-3231	118	2-3283	158	2-3328	107
2-3185	55	2-3232	118	2-3284	158	2-3329	110
2-3186	53	2-3233	118	2-3285	158	2-3330	110
2-3187	54	2-3234	118	2-3286	158	2-3331	110
2-3188	54	2-3235	118	2-3287	158	2-3332	110
2-3189	55	2-3236	118	2-3288	158	2-3333	109
2-3190	53	2-3237	118	2-3289	158	2-3334	109
2-3191	54	2-3238	118	2-3290	159	2-3335	163
2-3192	54	2-3239	118	2-3291	159	2-3336	114
2-3193	55	2-3240	119	2-3292	159	2-3337	114
2-3194	53	2-3241	119	2-3293	159	2-3338	121
2-3195	54	2-3242	119	2-3294	159	2-3339	121
2-3196	54	2-3243	119	2-3295	159	2-3340	126
2-3197	55	2-3244	119	2-3296	159	2-3341	126
2-3198	53	2-3245	119	2-3297	159	2-3342	128
2-3199	54	2-3246	119	2-3298	159	2-3343	128
2-3200	54	2-3247	119	2-3299	159	2-3344	132
2-3201	55	2-3248	119	2-3300	159	2-3345	132
2-3202	164	2-3249	119	2-3301	159	2-3346	134
2-3202	165	2-3250	119	2-3302	159	2-3347	135
2-3202	282	2-3251	119	2-3303	159	2-3348	135
2-3203	164	2-3252	119	2-3304	159	2-3349	47
2-3203	165	2-3253	119	2-3305	159	2-3350	47
2-3203	282	2-3254	119	2-3306	159	2-3351	47
2-3204	164	2-3255	119	2-3307	159	2-3352	47
2-3204	165	2-3256	119	2-3308	159	2-3353	47
2-3204	282	2-3257	119	2-3309	159	2-3354	47
2-3206	199	2-3258	119	2-3310	159	2-3355	47
2-3207	199	2-3259	119	2-3310	275	2-3356	47
2-3208	199	2-3260	158	2-3311	159	2-3357	47
2-3209	199	2-3261	158	2-3311	275	2-3358	47

Índice de referencias

CÓDIGO	PÁGINA
2-3359	47
2-3360	47
2-3361	48
2-3362	48
2-3363	48
2-3364	48
2-3365	48
2-3366	48
2-3367	48
2-3368	48
2-3369	48
2-3370	48
2-3371	48
2-3372	48
2-3372	48
2-3373	48
2-3375	50
2-3376	50
2-3377	50
2-3378	50
2-3379	50
2-3380	50
2-3381	50
2-3382	50
2-3383	50
2-3384	50
2-3385	50
2-3386	50
2-3387	51
2-3388	51
2-3389	51
2-3390	51
2-3391	51
2-3392	51
2-3393	51
2-3394	51
2-3395	111
2-3395	157
2-3395	277
2-3396	111
2-3396	277
2-3397	111
2-3397	157
2-3397	277
2-3398	111
2-3398	277
2-3399	111
2-3400	111
2-3401	111
2-3402	111
2-3403	111
2-3404	111

CÓDIGO	PÁGINA
2-3405	111
2-3406	111
2-3407	111
2-3408	111
2-3409	111
2-3410	111
2-3411	111
2-3412	111
2-3413	111
2-3414	111
2-3415	111
2-3416	111
2-3417	157
2-3418	157
2-3419	157
2-3420	157
2-3421	157
2-3422	157
2-3423	157
2-3424	157
2-3425	157
2-3426	157
2-3427	111
2-3428	111
2-3429	111
2-3430	111
2-3431	48
2-3432	48
2-3433	48
2-3434	48
2-3435	118
2-3436	118
2-3437	59
2-3437	278
2-3438	278
2-3439	278
2-3440	278
2-3441	127
2-3441	281
2-3442	127
2-3442	281
2-3443	129
2-3443	282
2-3444	129
2-3444	282
2-3445	162
2-3445	163
2-3445	281
2-3446	162
2-3446	163
2-3446	281
2-3447	164

CÓDIGO	PÁGINA
2-3447	165
2-3447	282
2-3448	164
2-3448	165
2-3448	282
2-3449	126
2-3450	126
2-3451	126
2-3452	126
2-3453	126
2-3454	126
2-3455	127
2-3456	127
2-3459	128
2-3460	128
2-3461	128
2-3462	128
2-3463	128
2-3464	128
2-3465	129
2-3466	129
2-3467	129
2-3468	129
2-3469	162
2-3470	162
2-3471	162
2-3472	162
2-3473	162
2-3474	162
2-3475	163
2-3476	163
2-3477	163
2-3478	163
2-3479	164
2-3480	164
2-3481	164
2-3482	164
2-3483	164
2-3484	164
2-3485	165
2-3486	165
2-3487	165
2-3488	165
2-3489	126
2-3490	126
2-3491	128
2-3492	128
2-3493	162
2-3493	163
2-3493	281
2-3494	162
2-3494	163

CÓDIGO	PÁGINA
2-3494	281
2-3495	162
2-3495	163
2-3495	281
2-3496	115
2-3496	271
2-3497	114
2-3498	114
2-3499	114
2-3500	115
2-3501	115
2-3502	215
2-3503	203
2-3504	203
2-3505	203
2-3506	203
2-3507	203
2-3508	227
2-3508	282
2-3509	227
2-3509	282
2-3510	227
2-3510	282
2-3511	227
2-3511	282
2-3528	87
2-3529	87
2-3530	87
2-3531	87
2-3532	87
2-3533	87
2-3534	49
2-3535	49
2-3536	49
2-3537	49
2-3538	49
2-3539	49
2-3540	49
2-3541	49
2-3542	55
2-3543	55
2-3544	55
2-3545	55
2-3546	48
2-3547	48
2-3548	111
2-3548	277
2-3549	111
2-3549	277
2-3550	111
2-3551	111
2-3552	111

Índice de referencias

CÓDIGO	PÁGINA	CÓDIGO	PÁGINA	CÓDIGO	PÁGINA	CÓDIGO	PÁGINA
2-3553	111	2-3604	278	2-3681	75	2-3747	117
2-3554	111	2-3607	88	2-3682	75	2-3747	272
2-3555	111	2-3608	88	2-3683	75	2-3748	117
2-3556	111	2-3609	88	2-3684	75	2-3748	272
2-3557	111	2-3610	88	2-3685	75	2-3749	117
2-3558	111	2-3611	88	2-3686	75	2-3749	272
2-3559	111	2-3612	88	2-3687	75	2-3750	117
2-3560	111	2-3622	92	2-3688	75	2-3750	272
2-3561	111	2-3624	51	2-3690	57	2-3751	116
2-3563	47	2-3625	51	2-3691	57	2-3752	116
2-3564	47	2-3639	250	2-3692	57	2-3753	116
2-3565	47	2-3640	250	2-3692	123	2-3754	117
2-3566	47	2-3641	73	2-3693	57	2-3755	117
2-3567	47	2-3642	73	2-3693	123	2-3756	116
2-3568	47	2-3643	73	2-3694	57	2-3757	116
2-3569	200	2-3644	73	2-3694	123	2-3758	116
2-3570	200	2-3645	73	2-3695	57	2-3759	116
2-3571	200	2-3646	73	2-3695	123	2-3760	116
2-3572	200	2-3647	74	2-3696	123	2-3761	116
2-3573	200	2-3648	74	2-3697	123	2-3762	117
2-3574	200	2-3649	74	2-3698	75	2-3763	117
2-3575	200	2-3650	74	2-3699	75	2-3764	117
2-3576	200	2-3651	74	2-3700	75	2-3765	117
2-3577	120	2-3652	74	2-3701	75	2-3766	116
2-3577	183	2-3653	136	2-3702	190	2-3767	116
2-3577	273	2-3654	136	2-3703	190	2-3768	116
2-3578	183	2-3655	92	2-3704	190	2-3769	117
2-3579	183	2-3656	51	2-3705	190	2-3770	117
2-3580	183	2-3657	74	2-3706	95	2-3771	116
2-3581	183	2-3658	74	2-3707	95	2-3772	116
2-3582	183	2-3659	74	2-3708	95	2-3773	116
2-3583	130	2-3660	74	2-3709	96	2-3774	117
2-3583	186	2-3661	74	2-3710	96	2-3775	117
2-3583	283	2-3662	74	2-3711	96	2-3776	116
2-3584	186	2-3663	73	2-3712	96	2-3777	116
2-3585	186	2-3664	73	2-3713	96	2-3778	116
2-3586	186	2-3665	73	2-3714	96	2-3779	116
2-3587	186	2-3666	73	2-3715	95	2-3780	117
2-3588	186	2-3667	73	2-3716	95	2-3781	117
2-3590	41	2-3668	73	2-3717	95	2-3782	116
2-3591	41	2-3669	75	2-3724	76	2-3783	125
2-3593	41	2-3670	75	2-3725	76	2-3784	125
2-3594	41	2-3671	75	2-3726	76	2-3785	125
2-3595	41	2-3672	75	2-3727	76	2-3786	125
2-3596	41	2-3673	75	2-3728	76	2-3787	149
2-3597	41	2-3674	75	2-3729	76	2-3788	149
2-3598	41	2-3675	75	2-3742	48	2-3807	43
2-3599	41	2-3676	75	2-3743	48	2-3808	43
2-3600	41	2-3677	75	2-3744	47	2-3809	43
2-3601	284	2-3678	75	2-3745	47	2-3810	43
2-3602	284	2-3679	75	2-3746	117	2-3811	43
2-3603	284	2-3680	75	2-3746	272	2-3812	43

Índice de referencias

CÓDIGO	PÁGINA
2-3813	44
2-3814	44
2-3815	44
2-3816	44
2-3817	44
2-3818	44
2-3819	44
2-3820	44
2-3821	44
2-3822	44
2-3823	44
2-3824	44
2-3825	43
2-3826	43
2-3827	43
2-3828	43
2-3829	43
2-3830	43
2-3831	44
2-3832	44
2-3833	44
2-3834	44
2-3835	44
2-3836	44
2-3837	44
2-3838	44
2-3839	44
2-3840	44
2-3841	44
2-3842	44
2-3845	101
2-3846	101
2-3847	101
2-3848	101
2-3849	100
2-3850	100
2-3851	100
2-3852	100
2-3853	100
2-3854	100
2-3855	100
2-3856	100
2-3857	100
2-3858	100
2-3859	100
2-3860	100
2-3861	100
2-3862	100
2-3863	100
2-3864	100
2-3865	99
2-3866	99

CÓDIGO	PÁGINA
2-3867	99
2-3868	99
2-3869	99
2-3870	99
2-3871	99
2-3872	99
2-3873	103
2-3874	103
2-3875	103
2-3876	103
2-3877	103
2-3878	103
2-3879	103
2-3880	103
2-3881	103
2-3882	103
2-3883	103
2-3884	103
2-3885	103
2-3886	103
2-3887	103
2-3888	103
2-3889	103
2-3890	103
2-3892	103
2-3893	103
2-3894	103
2-3896	103
2-3897	103
2-3898	103
2-3900	103
2-3901	103
2-3902	103
2-3904	103
2-3911	45
2-3912	45
2-3913	45
2-3920	101
2-3921	101
2-3922	101
2-3923	101
2-3924	123
2-3925	123
2-3926	123
2-3927	123
2-3928	123
2-3929	123
2-3930	58
2-3931	58
2-3932	58
2-3933	58
2-3934	58

CÓDIGO	PÁGINA
2-3935	58
2-3936	58
2-3937	58
2-3938	58
2-3939	59
2-3940	59
2-3941	59
2-3942	59
2-3943	59
2-3944	59
2-3945	59
2-3946	59
2-3947	59
2-3948	58
2-3949	58
2-3950	58
2-3951	58
2-3952	58
2-3953	58
2-3954	60
2-3955	60
2-3956	60
2-3957	60
2-3958	60
2-3959	60
2-3966	101
2-3967	101
2-3968	101
2-3969	101
2-3970	122
2-3971	122
2-3972	122
2-3973	122
2-3974	122
2-3975	122
2-3976	88
2-3977	88
2-3978	88
2-3979	101
2-3980	101
2-3981	101
2-3982	101
2-3983	122
2-3984	122
2-3985	122
2-3986	122
2-3987	122
2-3988	122
2-3989	88
2-3990	88
2-3991	88
2-3992	88

CÓDIGO	PÁGINA
2-3992	60
2-3992	122
2-3992	279
2-3993	60
2-3993	88
2-3993	122
2-3993	279
2-3994	77
2-3995	77
2-3996	76
2-3997	77
2-3998	77
2-3999	76
2-4002	90
2-4002	170
2-4002	288
2-4003	90
2-4004	90
2-4005	90
2-4006	134
2-4007	134
2-4008	134
2-4009	134
2-4010	170
2-4011	170
2-4012	170
2-4036	78
2-4036	92
2-4036	104
2-4036	136
2-4037	78
2-4037	92
2-4037	104
2-4037	136
2-4039	54
2-4040	54
2-4041	54
2-4042	55
2-4043	55
2-4044	55
2-4045	55
2-4046	55
2-4047	53
2-4048	53
2-4049	53
2-4050	54
2-4051	54
2-4052	54
2-4053	60
2-4054	60
2-4055	60
2-4056	60

Índice de referencias

CÓDIGO	PÁGINA	CÓDIGO	PÁGINA	CÓDIGO	PÁGINA	CÓDIGO	PÁGINA
2-4057	60	2-4121	134	2-4173	165	2-4222	128
2-4058	60	2-4122	129	2-4174	165	2-4223	128
2-4059	55	2-4123	129	2-4175	165	2-4224	129
2-4059	279	2-4124	129	2-4176	170	2-4225	129
2-4060	55	2-4125	133	2-4177	170	2-4226	128
2-4060	279	2-4126	133	2-4178	170	2-4227	128
2-4061	53	2-4127	133	2-4179	170	2-4228	128
2-4061	274	2-4128	133	2-4180	102	2-4229	128
2-4063	110	2-4129	133	2-4181	102	2-4230	128
2-4064	134	2-4130	133	2-4182	102	2-4231	128
2-4065	134	2-4131	134	2-4183	102	2-4232	129
2-4066	109	2-4132	134	2-4184	74	2-4233	129
2-4067	117	2-4133	135	2-4185	74	2-4234	129
2-4068	133	2-4134	155	2-4186	74	2-4235	129
2-4069	127	2-4135	155	2-4187	102	2-4236	128
2-4070	113	2-4136	155	2-4188	102	2-4237	128
2-4071	113	2-4137	155	2-4189	102	2-4238	128
2-4072	135	2-4138	156	2-4190	102	2-4239	129
2-4073	129	2-4139	156	2-4191	74	2-4240	129
2-4074	127	2-4140	156	2-4192	74	2-4241	127
2-4075	129	2-4141	156	2-4193	74	2-4243	127
2-4076	119	2-4142	159	2-4195	127	2-4245	129
2-4077	133	2-4143	159	2-4195	281	2-4246	129
2-4078	115	2-4144	159	2-4196	127	2-4247	129
2-4086	109	2-4145	159	2-4196	127	2-4248	129
2-4087	109	2-4146	167	2-4196	281	2-4249	41
2-4088	109	2-4147	167	2-4197	127	2-4250	41
2-4089	110	2-4148	167	2-4197	281	2-4251	41
2-4090	110	2-4149	167	2-4198	129	2-4251	289
2-4091	110	2-4150	167	2-4198	282	2-4252	41
2-4092	113	2-4151	167	2-4199	129	2-4253	41
2-4093	113	2-4152	167	2-4199	129	2-4254	41
2-4094	113	2-4153	167	2-4199	282	2-4255	41
2-4095	113	2-4154	169	2-4200	129	2-4256	41
2-4096	113	2-4155	169	2-4200	282	2-4257	41
2-4097	113	2-4156	169	2-4201	126	2-4258	41
2-4098	115	2-4157	169	2-4202	126	2-4259	115
2-4099	115	2-4158	161	2-4203	126	2-4259	271
2-4100	115	2-4159	161	2-4204	127	2-4260	114
2-4101	117	2-4160	163	2-4206	126	2-4261	114
2-4102	117	2-4161	163	2-4207	126	2-4262	114
2-4103	117	2-4162	163	2-4208	126	2-4263	115
2-4104	119	2-4163	163	2-4209	126	2-4264	115
2-4105	119	2-4164	163	2-4210	126	2-4265	132
2-4106	119	2-4165	163	2-4211	126	2-4266	132
2-4107	130	2-4166	163	2-4212	127	2-4267	132
2-4108	130	2-4167	163	2-4213	127	2-4268	133
2-4113	127	2-4168	165	2-4216	126	2-4269	133
2-4114	127	2-4169	165	2-4217	126	2-4270	130
2-4119	129	2-4170	165	2-4218	126	2-4271	130
2-4120	129	2-4171	165	2-4219	127	2-4272	130
2-4121	129	2-4172	165	2-4221	128	2-4273	130

Índice de referencias

CÓDIGO	PÁGINA	CÓDIGO	PÁGINA	CÓDIGO	PÁGINA	CÓDIGO	PÁGINA
2-4274	130	2-4392	124	2-4440	171	2-4516	179
2-4333	177	2-4393	124	2-4441	171	2-4517	88
2-4334	177	2-4394	124	2-4442	171	2-4518	88
2-4335	178	2-4395	124	2-4443	135	2-4519	88
2-4336	178	2-4396	124	2-4444	171	2-4520	88
2-4337	205	2-4397	124	2-4445	114	2-4520	279
2-4338	207	2-4398	124	2-4446	114	2-4521	90
2-4339	179	2-4399	124	2-4447	114	2-4522	134
2-4340	179	2-4400	59	2-4448	115	2-4523	134
2-4347	112	2-4401	59	2-4449	115	2-4524	134
2-4348	112	2-4402	59	2-4450	115	2-4525	134
2-4350	113	2-4403	59	2-4451	115	2-4526	134
2-4351	113	2-4404	59	2-4452	114	2-4527	134
2-4352	112	2-4405	59	2-4453	114	2-4528	134
2-4353	112	2-4406	53	2-4454	114	2-4529	286
2-4355	113	2-4407	53	2-4455	115	2-4530	286
2-4356	113	2-4408	53	2-4456	115	2-4531	286
2-4357	284	2-4409	53	2-4457	114	2-4532	286
2-4358	284	2-4410	53	2-4458	114	2-4533	286
2-4359	284	2-4411	53	2-4459	114	2-4540	143
2-4360	108	2-4412	57	2-4460	115	2-4541	143
2-4361	108	2-4413	57	2-4461	115	2-4542	143
2-4362	108	2-4414	57	2-4462	114	2-4543	143
2-4363	108	2-4415	57	2-4463	114	2-4544	143
2-4364	108	2-4416	57	2-4464	114	2-4545	143
2-4365	108	2-4417	57	2-4465	114	2-4546	143
2-4366	108	2-4418	49	2-4466	115	2-4547	143
2-4367	108	2-4419	49	2-4467	115	2-4548	143
2-4368	108	2-4420	49	2-4468	114	2-4549	143
2-4369	108	2-4421	49	2-4469	114	2-4550	143
2-4370	108	2-4422	49	2-4470	114	2-4551	285
2-4371	108	2-4423	49	2-4471	114	2-4552	67
2-4372	99	2-4424	49	2-4472	115	2-4553	67
2-4373	99	2-4425	49	2-4473	115	2-4554	67
2-4374	99	2-4426	49	2-4474	135	2-4555	67
2-4375	99	2-4427	115	2-4474	171	2-4556	67
2-4376	99	2-4427	271	2-4474	289	2-4557	67
2-4377	99	2-4428	115	2-4476	207	2-4558	67
2-4378	99	2-4428	271	2-4477	207	2-4559	67
2-4379	99	2-4429	115	2-4478	208	2-4560	67
2-4380	102	2-4429	271	2-4479	208	2-4561	67
2-4381	102	2-4430	115	2-4480	205	2-4562	67
2-4382	102	2-4430	271	2-4481	205	2-4563	133
2-4383	102	2-4431	135	2-4487	49	2-4563	286
2-4384	102	2-4432	135	2-4488	49	2-4564	132
2-4385	102	2-4433	135	2-4489	49	2-4565	132
2-4386	102	2-4434	135	2-4508	177	2-4566	132
2-4387	102	2-4435	135	2-4509	177	2-4567	133
2-4388	124	2-4436	135	2-4510	177	2-4568	133
2-4389	124	2-4437	171	2-4512	178	2-4569	119
2-4390	124	2-4438	171	2-4514	179	2-4570	119
2-4391	124	2-4439	171	2-4515	179	2-4571	159

Índice de referencias

CÓDIGO	PÁGINA	CÓDIGO	PÁGINA	CÓDIGO	PÁGINA	CÓDIGO	PÁGINA
2-4572	159	2-4631	86	2-4679	191	2-4733	190
2-4573	119	2-4632	86	2-4680	283	2-4734	190
2-4574	119	2-4633	208	2-4684	107	2-4735	190
2-4575	159	2-4634	208	2-4685	121	2-4736	190
2-4576	159	2-4635	205	2-4686	109	2-4737	190
2-4585	189	2-4636	205	2-4687	195	2-4738	190
2-4586	189	2-4636	205	2-4688	195	2-4739	155
2-4587	189	2-4637	193	2-4689	195	2-4739	155
2-4588	189	2-4638	193	2-4690	195	2-4739	276
2-4589	189	2-4639	193	2-4691	160	2-4740	155
2-4590	189	2-4640	193	2-4692	160	2-4740	155
2-4591	189	2-4641	193	2-4693	160	2-4740	276
2-4592	189	2-4642	193	2-4693	160	2-4741	157
2-4593	189	2-4643	193	2-4694	161	2-4741	277
2-4594	189	2-4644	193	2-4695	161	2-4742	157
2-4595	189	2-4645	193	2-4696	161	2-4742	277
2-4596	189	2-4646	193	2-4697	161	2-4743	155
2-4597	189	2-4647	193	2-4698	131	2-4744	155
2-4598	189	2-4648	193	2-4699	131	2-4745	155
2-4599	189	2-4651	121	2-4700	131	2-4746	155
2-4600	189	2-4651	279	2-4701	131	2-4747	155
2-4601	189	2-4652	121	2-4702	131	2-4748	155
2-4602	189	2-4653	121	2-4703	131	2-4749	155
2-4603	189	2-4654	121	2-4704	131	2-4750	155
2-4604	189	2-4655	121	2-4705	131	2-4751	155
2-4605	189	2-4656	121	2-4706	131	2-4752	155
2-4606	189	2-4657	121	2-4707	131	2-4753	157
2-4607	189	2-4658	121	2-4708	131	2-4754	157
2-4608	189	2-4659	293	2-4709	131	2-4755	157
2-4609	190	2-4660	293	2-4710	131	2-4756	157
2-4610	190	2-4661	293	2-4711	131	2-4757	157
2-4611	190	2-4662	293	2-4712	131	2-4758	157
2-4612	190	2-4663	293	2-4713	131	2-4759	157
2-4613	190	2-4664	293	2-4714	131	2-4760	157
2-4614	190	2-4665	292	2-4715	131	2-4761	157
2-4615	190	2-4666	292	2-4716	131	2-4762	157
2-4616	190	2-4667	143	2-4717	131	2-4763	289
2-4617	190	2-4668	143	2-4718	131	2-4764	191
2-4618	190	2-4669	143	2-4719	131	2-4765	191
2-4619	190	2-4669	292	2-4720	131	2-4766	191
2-4620	190	2-4670	86	2-4721	131	2-4767	191
2-4621	190	2-4671	86	2-4722	131	2-4768	191
2-4622	190	2-4672	86	2-4723	131	2-4769	191
2-4623	190	2-4673	86	2-4724	131	2-4770	191
2-4624	190	2-4673	160	2-4725	131	2-4771	191
2-4625	190	2-4673	161	2-4726	131	2-4772	191
2-4626	190	2-4673	281	2-4727	190	2-4773	191
2-4627	190	2-4674	191	2-4728	190	2-4774	120
2-4628	190	2-4675	191	2-4729	190	2-4775	120
2-4629	86	2-4676	191	2-4730	190	2-4776	120
2-4629	281	2-4677	191	2-4731	190	2-4777	120
2-4630	86	2-4678	191	2-4732	190	2-4778	120

Índice de referencias

CÓDIGO	PÁGINA
2-4779	120
2-4780	120
2-4781	120
2-4782	120
2-4783	120
2-4784	120
2-4785	120
2-4786	120
2-4787	120
2-4788	120
2-4789	120
2-4790	120
2-4791	120
2-4792	120
2-4793	120
2-4794	120
2-4795	120
2-4796	191
2-4797	191
2-4798	191
2-4799	191
2-4800	191
2-4801	191
2-4802	191
2-4803	191
2-4804	191
2-4805	191
2-4806	191
2-4807	191
2-4808	264
2-4809	264
2-4810	264
2-4811	264
2-4812	122
2-4812	279
2-4813	122
2-4814	122
2-4815	122
2-4816	122
2-4817	122
2-4828	120
2-4829	120
2-4830	120
2-4831	120
2-4832	120
2-4833	131
2-4834	131
2-4835	131
2-4836	131
2-4837	131
2-4838	109
2-4839	109

CÓDIGO	PÁGINA
2-4840	109
2-4841	109
2-4842	109
2-4843	110
2-4844	110
2-4845	110
2-4846	110
2-4847	110
2-4848	112
2-4849	112
2-4851	113
2-4852	113
2-4853	112
2-4854	112
2-4856	113
2-4857	113
2-4858	114
2-4859	114
2-4860	114
2-4861	115
2-4862	115
2-4863	116
2-4864	116
2-4865	116
2-4866	117
2-4867	117
2-4868	118
2-4869	118
2-4870	118
2-4871	119
2-4872	119
2-4873	118
2-4874	118
2-4875	118
2-4876	119
2-4877	119
2-4878	130
2-4879	130
2-4881	130
2-4882	130
2-4883	126
2-4884	126
2-4885	126
2-4886	127
2-4888	126
2-4889	126
2-4890	126
2-4891	127
2-4893	126
2-4894	126
2-4895	126
2-4896	127

CÓDIGO	PÁGINA
2-4898	128
2-4899	128
2-4900	128
2-4901	129
2-4902	129
2-4903	128
2-4904	128
2-4905	128
2-4906	129
2-4907	129
2-4908	128
2-4909	128
2-4910	128
2-4911	129
2-4912	129
2-4913	132
2-4914	132
2-4915	132
2-4916	133
2-4917	133
2-4918	132
2-4919	132
2-4920	132
2-4921	133
2-4922	133
2-4923	155
2-4924	155
2-4925	155
2-4926	155
2-4927	155
2-4928	156
2-4929	156
2-4930	156
2-4931	156
2-4932	156
2-4933	158
2-4934	158
2-4935	158
2-4936	159
2-4937	159
2-4938	158
2-4939	158
2-4940	158
2-4941	159
2-4942	159
2-4943	166
2-4944	166
2-4945	166
2-4946	167
2-4947	167
2-4948	166
2-4949	166

CÓDIGO	PÁGINA
2-4950	166
2-4951	167
2-4952	167
2-4953	162
2-4954	162
2-4955	162
2-4956	163
2-4957	163
2-4958	162
2-4959	162
2-4960	162
2-4961	163
2-4962	163
2-4963	164
2-4964	164
2-4965	164
2-4966	165
2-4967	165
2-4968	164
2-4969	164
2-4970	164
2-4971	165
2-4972	165
2-4973	114
2-4974	114
2-4975	114
2-4976	115
2-4977	115
2-4978	91
2-4979	91
2-4980	91
2-4983	90
2-4984	90
2-4985	90
2-4986	195
2-4987	195
2-4988	195
2-4989	195
2-4990	193
2-4991	193
2-4992	193
3-0001	233
3-0003	233
3-0004	205
3-0005	233
3-0006	233
3-0007	233
3-0008	205
3-0009	233
3-0010	233
3-0012	223
3-0014	223

Índice de referencias

CÓDIGO	PÁGINA	CÓDIGO	PÁGINA	CÓDIGO	PÁGINA	CÓDIGO	PÁGINA
3-0016	235	4-0013	169	4-0100	140	4-0380	65
3-0017	235	4-0013	284	4-0101	140	4-0381	65
3-0019	235	4-0014	284	4-0102	140	4-0382	65
3-0020	235	4-0015	60	4-0106	141	4-0383	65
3-0021	235	4-0015	64	4-0109	140	4-0434	167
3-0022	235	4-0015	75	4-0110	140	4-0475	274
4-0001	140	4-0015	82	4-0111	140	4-0479	86
4-0001	284	4-0015	89	4-0112	140	4-0479	125
4-0002	140	4-0015	284	4-0113	140	4-0479	281
4-0002	284	4-0016	55	4-0114	140	4-0480	96
4-0003	89	4-0016	284	4-0115	140	4-0480	81
4-0003	140	4-0017	64	4-0119	141	4-0480	86
4-0003	168	4-0017	284	4-0143	64	4-0480	139
4-0003	169	4-0018	55	4-0144	64	4-0480	281
4-0003	284	4-0018	64	4-0145	64	4-0481	81
4-0004	82	4-0018	284	4-0146	64	4-0481	86
4-0004	284	4-0019	284	4-0147	64	4-0481	96
4-0005	82	4-0021	179	4-0148	64	4-0481	139
4-0005	89	4-0021	208	4-0150	64	4-0481	281
4-0005	140	4-0021	290	4-0151	64	4-0482	63
4-0005	284	4-0023	133	4-0152	64	4-0482	74
4-0007	82	4-0023	166	4-0161	64	4-0482	81
4-0007	89	4-0023	167	4-0162	64	4-0482	86
4-0007	140	4-0023	174	4-0163	64	4-0482	125
4-0007	284	4-0023	286	4-0164	64	4-0482	139
4-0008	82	4-0024	133	4-0166	64	4-0482	160
4-0008	89	4-0024	166	4-0167	64	4-0482	161
4-0008	140	4-0024	167	4-0168	64	4-0482	281
4-0008	284	4-0024	174	4-0169	64	4-0484	63
4-0009	64	4-0024	286	4-0172	64	4-0484	74
4-0009	75	4-0025	133	4-0231	139	4-0484	81
4-0009	82	4-0025	166	4-0235	58	4-0484	86
4-0009	89	4-0025	167	4-0235	63	4-0484	125
4-0009	140	4-0025	174	4-0235	73	4-0484	281
4-0009	168	4-0025	286	4-0235	81	4-0485	281
4-0009	169	4-0027	133	4-0235	86	4-0486	63
4-0009	284	4-0027	166	4-0235	270	4-0486	74
4-0010	284	4-0027	167	4-0263	139	4-0486	81
4-0011	60	4-0027	286	4-0264	139	4-0486	86
4-0011	64	4-0046	166	4-0265	139	4-0486	125
4-0011	75	4-0046	167	4-0266	139	4-0486	160
4-0011	82	4-0046	286	4-0268	139	4-0486	161
4-0011	89	4-0047	166	4-0270	140	4-0486	281
4-0011	140	4-0047	167	4-0271	140	4-0488	63
4-0011	284	4-0047	286	4-0272	140	4-0488	74
4-0012	55	4-0048	166	4-0273	140	4-0488	81
4-0012	284	4-0048	167	4-0276	141	4-0488	86
4-0013	64	4-0048	286	4-0277	141	4-0488	125
4-0013	75	4-0096	140	4-0279	141	4-0488	281
4-0013	82	4-0097	140	4-0281	141	4-0514	81
4-0013	89	4-0098	140	4-0378	65	4-0514	139
4-0013	168	4-0099	140	4-0379	65	4-0514	270

Índice de referencias

CÓDIGO	PÁGINA
4-0516	81
4-0516	86
4-0516	139
4-0516	270
4-0518	63
4-0518	139
4-0518	73
4-0518	81
4-0518	86
4-0518	270
4-0523	54
4-0523	63
4-0523	270
4-0526	270
4-0546	278
4-0556	83
4-0556	141
4-0556	288
4-0558	83
4-0558	91
4-0558	141
4-0558	288
4-0559	65
4-0559	75
4-0559	83
4-0559	91
4-0559	141
4-0559	288
4-0560	65
4-0560	75
4-0560	83
4-0560	91
4-0560	141
4-0560	288
4-0562	65
4-0562	75
4-0562	83
4-0562	91
4-0562	288
4-0563	65
4-0563	75
4-0563	83
4-0563	91
4-0563	288
4-0568	65
4-0568	288
4-0569	69
4-0572	69
4-0743	109
4-0743	109
4-0743	271
4-0744	109

CÓDIGO	PÁGINA
4-0744	271
4-0745	109
4-0745	271
4-0752	271
4-0763	251
4-0764	251
4-0765	251
4-0767	255
4-0767	255
4-0768	255
4-0768	255
4-0770	255
4-0772	257
4-0782	275
4-0783	275
4-0784	81
4-0785	82
4-0786	82
4-0787	83
4-0788	82
4-0789	82
4-0790	83
4-0791	81
4-0792	82
4-0793	82
4-0794	83
4-0795	81
4-0796	82
4-0797	82
4-0798	83
4-0800	82
4-0801	83
4-0803	82
4-0804	82
4-0805	83
4-0807	82
4-0808	82
4-0809	83
4-0811	82
4-0812	82
4-0813	82
4-0814	82
4-0815	82
4-0816	82
4-0817	82
4-0818	82
4-0819	82
4-0846	83
4-0847	82
4-0855	83
4-0857	83
4-0859	83

CÓDIGO	PÁGINA
4-0861	83
4-0862	81
4-0863	82
4-0900	253
4-0901	253
4-0902	253
4-0903	254
4-0904	254
4-0905	254
4-0906	254
4-0907	254
4-0922	254
4-0923	254
4-0924	254
4-0925	254
4-0926	254
4-0928	257
4-0929	257
4-0935	63
4-0936	63
4-0937	63
4-0938	63
4-0939	63
4-0940	63
4-0941	63
4-0942	63
4-0951	81
4-0952	81
4-0953	81
4-0954	81
4-0955	81
4-0956	81
4-0957	81
4-0958	81
4-0959	81
4-0960	81
4-0961	81
4-0962	81
4-0995	85
4-0995	107
4-0995	274
4-0996	85
4-0996	95
4-0996	274
4-0997	57
4-0997	85
4-0997	107
4-0997	274
4-0998	57
4-0998	85
4-0998	107
4-0998	274

CÓDIGO	PÁGINA
4-0999	53
4-0999	107
4-0999	274
4-1027	255
4-1028	257
4-1029	257
4-1030	257
4-1031	257
4-1032	257
4-1033	257
4-1049	47
4-1056	50
4-1058	47
4-1065	50
4-1072	255
4-1133	65
4-1134	65
4-1135	65
4-1136	65
4-1193	81
4-1194	81
4-1200	82
4-1201	82
4-1202	82
4-1203	82
4-1210	81
4-1211	81
4-1216	82
4-1217	82
4-1230	48
4-1231	48
4-1241	257
4-1242	255
4-1243	255
4-1255	254
4-1256	254
4-1258	254
4-1259	254
4-1260	257
4-1261	257
4-1262	250
4-1263	250
4-1290	277
4-1291	277
4-1292	277
4-1293	277
4-1294	277
4-1295	139
4-1296	139
4-1297	139
4-1298	139
4-1304	77

Índice de referencias

CÓDIGO	PÁGINA	CÓDIGO	PÁGINA	CÓDIGO	PÁGINA	CÓDIGO	PÁGINA
4-1304	293	4-1568	255	4-1648	288		
4-1305	293	4-1602	197	4-1649	288		
4-1306	293	4-1603	197	4-1650	288		
4-1307	293	4-1604	197	4-1651	288		
4-1308	293	4-1605	197	4-1652	278		
4-1309	293	4-1606	107	4-1653	278		
4-1319	245	4-1606	274	4-1654	58		
4-1320	245	4-1607	168	4-1654	123		
4-1321	245	4-1607	169	4-1654	280		
4-1322	245	4-1607	284	4-1657	74		
4-1323	245	4-1608	278	4-1657	280		
4-1324	245	4-1609	278	4-1658	74		
4-1325	245	4-1610	278	4-1658	280		
4-1326	245	4-1611	81	4-1659	57		
4-1327	245	4-1612	81	4-1659	108		
4-1328	245	4-1613	81	4-1659	274		
4-1329	245	4-1614	81	4-1660	57		
4-1330	245	4-1615	81	4-1660	108		
4-1535	89	4-1616	81	4-1660	274		
4-1535	140	4-1617	82	4-1661	59		
4-1535	168	4-1618	82	4-1661	124		
4-1535	168	4-1619	82	4-1661	280		
4-1535	169	4-1620	82	4-1662	59		
4-1535	284	4-1621	82	4-1662	124		
4-1538	77	4-1622	82	4-1662	280		
4-1538	292	4-1623	278	4-1663	293		
4-1539	292	4-1626	253	4-1664	293		
4-1540	292	4-1627	253	4-1665	68		
4-1541	292	4-1628	253	4-1666	68		
4-1542	292	4-1629	253	4-1667	53		
4-1543	292	4-1633	254	4-1667	274		
4-1544	292	4-1634	254	4-1668	53		
4-1545	292	4-1635	254	4-1668	274		
4-1546	292	4-1636	254				
4-1547	292	4-1637	255				
4-1548	293	4-1638	255				
4-1549	293	4-1639	58				
4-1550	293	4-1639	270				
4-1551	293	4-1640	270				
4-1552	293	4-1641	58				
4-1553	293	4-1641	123				
4-1554	197	4-1641	280				
4-1555	197	4-1642	54				
4-1556	197	4-1642	270				
4-1557	197	4-1643	54				
4-1562	277	4-1643	270				
4-1563	277	4-1644	54				
4-1564	277	4-1644	278				
4-1565	53	4-1645	54				
4-1565	274	4-1645	278				
4-1566	255	4-1646	253				
4-1567	255	4-1647	253				

Índice de referencias

CÓDIGO	PÁGINA
TW0022	297
TW0023	297
TW0024	299
TW0025	299
TW0026	299
TW0027	299
TW0028	299
TW0029	299
TW0030	299
TW0031	299
TW0032	299
TW0033	299
TW0034	299
TW0035	299
TW0036	299
TW0037	299
TW0038	299
TW0039	299
TW0040	299
TW0041	299
TW0042	301
TW0043	301
TW0044	301
TW0045	301
TW0046	301
TW0047	301
TW0048	301
TW0049	301
TW0050	301
TW0051	301
TW0052	301
TW0053	301
TW0054	301
TW0055	301
TW0056	301
TW0057	305
TW0058	305
TW0059	305
TW0060	305
TW0061	307
TW0062	307
TW0063	307
TW0064	307
TW0065	307
TW0066	307
TW0067	307
TW0068	307
TW0069	307
TW0070	307
TW0071	307
TW0072	307
TW0073	307

CÓDIGO	PÁGINA
TW0074	307
TW0075	307
TW0076	307
TW0077	309
TW0079	309
TW0080	309
TW0081	309
TW0082	309
TW0084	309
TW0085	309
TW0086	309
TW0087	309
TW0089	309
TW0090	309
TW0091	309
TW0092	309
TW0094	309
TW0095	309
TW0096	309
TW0097	311
TW0098	311
TW0099	311
TW0100	311
TW0101	313
TW0102	313
TW0103	313
TW0104	313
TW0105	313
TW0106	313
TW0107	313
TW0108	313
TW0109	317
TW0110	317
TW0111	317
TW0112	317
TW0113	317
TW0114	317
TW0115	317
TW0116	317
TW0117	317
TW0118	317
TW0119	317
TW0120	317
TW0121	317
TW0122	321
TW0123	321
TW0124	321
TW0125	299
TW0126	299
TW0127	299
TW0128	315
TW0129	315

CÓDIGO	PÁGINA
TW0130	315
TW0131	315
TW0132	315
TW0133	315
TW0134	315
TW0135	315
TW0136	311
TW0137	311
TW0138	311
TW0139	311
TW0140	311
TW0141	311
TW0142	311
TW0143	311
TW0144	311
TW0145	311
TW0146	311
TW0147	311
TW0148	297
TW0149	297
TW0150	319
TW0151	319
TW0152	319
TW0153	319
TW0154	319
TW0155	319
TW0156	319
TW0156	319
TW0156	319
TW0157	319
TW0158	319
TW0159	319
TW0160	319
TW0161	319
TW0162	319
TW0163	319
TW0164	320
TW0165	320
TW0166	320
TW0167	320
TW0168	320
TW0169	320
TW0170	320
TW0171	320
TW0172	320
TW0173	320
TW0174	320
TW0175	320
TW0176	320
TW0177	320
TW0192	319
TW0193	319

CÓDIGO	PÁGINA
TW0194	320
TW0195	320
TW0196	301
TW0197	301
TW0198	301
TW0199	301
TW0200	301
TW0201	301
TW0202	301
TW0203	301
TW0204	301
TW0205	301
TW0206	301
TW0207	301
TW0208	301
TW0209	301
TW0210	301
TW0211	302
TW0212	302
TW0213	302
TW0214	302
TW0215	302
TW0216	302
TW0217	302
TW0218	302
TW0219	302
TW0220	300
TW0221	300
TW0222	300
TW0223	300
TW0224	300
TW0225	300
TW0226	300
TW0227	300
TW0228	300
TW0229	311
TW0230	311
TW0231	311
TW0232	311
TW0233	311
TW0234	311
TW0235	311
TW0236	311
TW0237	311
TW0238	311
TW0239	311
TW0240	311
TW0241	311
TW0242	311
TW0243	311
TW0244	311
TW0245	311

Índice de referencias

CÓDIGO	PÁGINA	CÓDIGO	PÁGINA	CÓDIGO	PÁGINA	CÓDIGO	PÁGINA
TW0246	311	TW0298	299				
TW0247	311	TW0299	299				
TW0248	311	TW0300	299				
TW0249	307	TW0301	299				
TW0250	307	TW0302	300				
TW0251	307	TW0303	300				
TW0252	307	TW0304	300				
TW0253	300	TW0305	300				
TW0254	300	TW0306	300				
TW0255	300	TW0307	300				
TW0256	300	TW0308	302				
TW0257	300	TW0309	302				
TW0258	300	TW0310	302				
TW0259	300	TW0311	302				
TW0260	300	TW0312	302				
TW0261	300	TW0313	302				
TW0262	300						
TW0263	300						
TW0264	300						
TW0265	300						
TW0266	300						
TW0267	300						
TW0268	301						
TW0269	301						
TW0270	301						
TW0271	301						
TW0272	301						
TW0273	301						
TW0274	301						
TW0275	301						
TW0276	301						
TW0277	301						
TW0278	301						
TW0279	301						
TW0280	301						
TW0281	301						
TW0282	301						
TW0284	321						
TW0285	321						
TW0286	317						
TW0287	315						
TW0288	315						
TW0289	315						
TW0290	315						
TW0291	315						
TW0292	315						
TW0293	299						
TW0294	299						
TW0295	299						
TW0296	299						
TW0297	299						

SÍGUENOS EN REDES SOCIALES

Novedades, promociones, noticias, vídeos, comparativas y mucho más.



Te invitamos a ser parte de nuestra Comunidad RUEDAS ALEX. Seguirnos en nuestras diferentes redes sociales, es poder disfrutar de un canal VIP, que ponemos a tu disposición, para que seas el primero y mejor informado del sector. Podrás participar e interactuar, en todo momento, con nosotros,...

Te iremos informando sobre diversas temáticas, como son: Novedades, Eventos y ferias relacionadas con el Sector, Noticias relevantes, Promociones y nuevos recursos, Somos @ruedalexspain en twitter, en instagram, en facebook, en youtube y somos RUEDAS ALEX en linkedin, síguenos,...



- PROYECTOS Y SOLUCIONES
- CONSULTAS
- IDEAS Y CONSEJOS



**MOVING
INDUSTRY
FORWARD**

SOLICITE SU CATÁLOGO EN:
www.alex.es



Notas

www.mengual.com

www.mengual.com



© Copyright RUEDAS ALEX S.L.U. 2022

La reproducción total o parcial de este catálogo está totalmente prohibida sin el consentimiento previo por escrito de Ruedas Alex S.L.U.