

KLEIN

www.merisual.com





Presentación KLEIN/	
KLEIN Introduction	008
Conceptos arquitectónicos/	
Architectural concepts	016
Interiorismo vidrio/	
Glass Interior design	026
Interiorismo madera/	
Wood Interior design	096
Diseño industrial/	
Industrial design	130
Muebles y armarios/	
Furniture and wardrobes	142

**INTERIORISMO VIDRIO/
GLASS INTERIOR DESIGN** 026

ROLLGLASS+	032
FRONT NEW	036
LIGNEA NEW	040
UNIKGLASS+	046
LITE GLASS / LITE GLASS+	050
UNIKGLASS+ AIR	056
EXTENDO / EXTENDO CORNER	058
PANORAMIC	064
POCKET GLASS	068
ROLLGLASS	070
ROLLGLASS AUTOPORTANTE	072
ROLMATIC / ROLMATIC CORNER	076
UNIKMATIC / UNIKMATIC CORNER	078
UNIKSELF	082
UNIKAIR SELF	084
UNIKMATIC AIR	085
ROLLGLASS SELF	086
KT GLASS	088
NK GLASS	090
CLOS GLASS	091
STOCKGLASS	092

**INTERIORISMO MADERA/
WOOD INTERIOR DESIGN** 096

LITE / LITE+	102
SLID	108
NK	112
KT	114
LITE PAR	116
LITE FOLD	118
NK FOLD	122
NK PAR	123
KP	124
STOCKPANEL	126

**DISEÑO INDUSTRIAL/
INDUSTRIAL DESIGN** 130

K	134
PL	136
AR	138

**MUEBLES Y ARMARIOS/
FURNITURES AND
WARDROBES** 142

K	146
ROLL	148
ROLL TOP	150
NK PAR	152

Somos expertos en diseño y fabricación de sistemas para puertas y tabiques correderos y plegables. Nuestros valores se centran en una continua búsqueda de la excelencia, con el fin de conseguir la máxima satisfacción de nuestros clientes en términos de calidad, diseño, funcionalidad y servicio.

Damos apoyo a los profesionales de la arquitectura y de la construcción, involucrándonos en su proyecto desde su inicio, proporcionándoles aplicaciones que les ayudan a crear con total libertad conceptual espacios singulares y versátiles.

We are experts in the design and manufacturing of systems for sliding and folding partitions and doors. Our values are rooted in continuously striving for excellence, and thus ensuring that our customers are extremely satisfied with the quality, design, functionality and service that we offer.

We support professionals working in the fields of architecture and construction by being involved in their projects from the start and providing them with applications that allow them to create unique and versatile spaces with complete conceptual freedom.

+
85

YEARS
EXPERIENCE



NETWORK
WORLDWIDE

5

YEARS
WARRANTY







«Immer besser seit 1931»

Nuestra experiencia profesional se remonta a 1931, año de creación de nuestra empresa. Desde entonces, hemos evolucionado sin descanso, combinando nuestra vocación artesanal con los sistemas de producción más innovadores. El pequeño taller original se ha convertido en una empresa con presencia internacional, con filial en Estados Unidos.

Los valores que nos han guiado hasta aquí mantienen su plena vigencia: una incesante búsqueda de la excelencia, la apuesta por la inversión en I+D+i y una escucha activa de los profesionales de la arquitectura y la construcción cimientan el éxito global de la marca KLEIN y siguen marcando nuestro rumbo al futuro.

Our professional experience dates back to 1931, the year that our company was founded. Since then, we have continued to evolve, combining our artisanal craft with the most innovative production systems. The small workshop where we started has grown into an international company, with a subsidiary in the United States.

The values that have guided us to where we are today are still as present as ever: our relentless pursuit of excellence, commitment to investing in research, development and innovation, and active incorporation of ideas from professionals in the architecture and construction fields have laid the foundation for KLEIN's global success and continue to lead us on our path forward.





Nuestro departamento de I+D+i es el centro de nuestro proceso de diseño y creación de nuevos productos, guardianes de la altísima exigencia de la marca. En nuestras instalaciones de Barcelona llevamos a cabo todas las fases de diseño, modelización 3D, prototipado y ensayos, así como la fabricación de todos nuestros productos.

Nuestros sistemas son producidos a partir de aluminio de origen europeo únicamente. Superan la norma EN1527 mediante un test a más de 100.000 ciclos y ofrecen una garantía de 5 años.

Nos enorgullece el reconocimiento internacional de nuestros clientes y proveedores así como el aval recibido de los principales organismos de certificación internacionales y entidades de diseño.

Our R+D+i department is at the core of our new product design and creation process, guardians of the brand's extremely high standards. We carry out all phases of design, 3D modeling, prototyping and testing at our facilities in Barcelona, as well as the manufacturing of all our products.

Our systems are exclusively produced with European-made aluminum. After being tested to over 100,000 cycles, all of our systems exceed the EN 1527 standard and come with a 5-year warranty.

We are proud of our customers and suppliers' international recognition, as well as the backing we have received from leading international certification organizations and design entities.

Interiores únicos

Unique interiors

Conjugamos la luz y el movimiento para generar equilibrio en los espacios interiores. Innovamos para diseñar aplicaciones correderas y plegables que permitan al arquitecto conectar, abrir o crear estancias cómodas y bellas.

We combine light and movement to create balance in interior spaces. We innovate to design sliding and folding applications that allow architects to connect, open up and create comfortable and beautiful rooms.



Extendo | Interiorismo Vidrio - Glass Interior Design



Lite | Interiorismo Madera - Wood Interior Design



Rollglass | Interiorismo Vidrio - Glass Interior Design



LUZ

Light



Usamos la luz natural, fuente de vida y de alegría, como elemento creativo. La convertimos en herramienta arquitectónica transformadora de espacios llenos de fuerza y modernidad.

We use natural light, a source of life and joy, as a creative element, turning it into a transformative architectural tool capable of creating spaces full of strength and modernity.

Equi librio

Balance

Nuestros sistemas hacen realidad el concepto de fluidez espacial: son elementos de conexión, de equilibrio y armonía visual.

Our systems make the concept of spatial fluidity a reality: they are rooted in elements of connection, balance and visual harmony.



Movi miento

Movement

Slid Top & Lite Fold | Interiorismo Madera - Wood Interior Design

Generamos espacios dinámicos, capaces de transformarse mediante un movimiento orgánico que respeta los ritmos del habitar.

We generate dynamic spaces, capable of being transformed through organic movement that respects the rhythms of life.



reddot award 2018
winner



Delta Selection
ADI Awards
2018



EN-1527
Certified by IFT

Innovar con sentido

Innovate with meaning

Los sistemas KLEIN están pensados para añadir valor a los proyectos interiores: integración arquitectónica absoluta, creatividad proyectual sin límites, diferenciación en los acabados, facilidad de instalación y mantenimiento. La máxima calidad hasta en el más mínimo detalle.

KLEIN systems are designed to add value to interior design projects: total architectural integration, limitless project creativity, a variety of finishes, and easy installation and maintenance. The highest quality, down to the smallest detail.



www.rollglass.com

Novedades 2018

2018 news

NUEVOS FRONT & LIGNEA

Los nuevos sistemas FRONT y LIGNEA generan bellísimos espacios mediante una combinación de vidrios fijos con puertas correderas de madera alojados en un único perfil. Todos los detalles cuentan cuando se busca la perfección y la personalización.

NEW FRONT & LIGNEA

Our new FRONT and LIGNEA systems create beautiful spaces by combining fixed glass panels with sliding wood doors, both located on a single profile. Every last detail counts when striving for perfection and customization.



LigneA | Interiorismo Vidrio - Glass Interior Design



KSC-KLEIN SOFT CLOSING

Dispositivo de frenado propio testado a 100.000 ciclos según la norma EN 1527 y certificado por el sello IFT. Tecnología puntera para aplicaciones de vidrio y madera. Comodidad y seguridad para el usuario.

Our own braking device, tested to 100,000 cycles in accordance with the EN 1527 standard and certified by the seal of the IFT. Cutting-edge technology for glass and wood applications. Comfort and safety for the user.



**SISTEMA EMPOTRABLE PRE-MARCO
RECESSED FRAME TRACK**

Integración arquitectónica absoluta. Su montaje fácil, en dos fases, garantiza una máxima eficiencia y la invisibilidad del sistema.

Total architectural integration. Its easy installation, carried out in two phases, guarantees maximum efficiency and the invisibility of the system.



**NUEVOS ACABADOS EN NEGRO
Y BRONCE MATE**

**NEW BLACK AND BRONZE
MATTE FINISHES**

Personalización y carácter para proyectos únicos. Tendencia unida a elegancia.

Customization and character for one-of-a-kind projects. Trends combined with elegance.



www.mengual.com



INTERIORISMO
VIDRIO

Glass Interior Design

www.meritoblog.com

Vidrio: Transparencia y libertad

Glass: Transparency and freedom

ESPACIOS SIN FRONTERAS

Libertad para conectar, abrir o crear espacios, sin barreras. Aunque el cristal es pura transparencia, se convierte en protagonista de la arquitectura. Potencia la luz natural y juega con las sombras. Nuestros sistemas permiten poner en escena su espectacular belleza con absoluta sencillez. Sin marcos. Sin guías en el suelo. Menos es más.

SPACES WITHOUT BORDERS

Freedom to connect, open up or create spaces, without barriers. Although glass is pure transparency, it becomes the protagonist of the architecture, boosting natural light and playing with shadows. Our systems allow its spectacular beauty to be put on display with absolute simplicity. Without frames. Without floor tracks. Less is more.





























La nueva mordaza KLEIN+ sujeta el cristal mediante presión para evitar marcos y procesos de mecanizado. Sin guías en el suelo, el vidrio laminado o templado parece flotar y se desliza suavemente, cualquiera que sea su formato.

The new KLEIN+ clamp fastens the glass with pressure, doing away with the need for frames and drilling. Without any floor tracks, the laminated or tempered glass seems to float, sliding along smoothly, regardless of its size.



Unikglass+ | Interiorismo Vidrio - Glass Interior Design

APLICACIÓN/ APPLICATION	PRODUCTO/ PRODUCT	PÁG./ PAGE	PESO*/ WEIGHT*		FRENO BRAKE			INSTALACIÓN MOUNTING		
			≤100	>100	KBS	KSC	SELF	PARED WALL	TECHO CEILING	EMPOTRABLE RECESSED
PUERTAS CORREDERAS ÚNICAS/ SINGLE SLIDING DOORS		UNIKGLASS+	046	●	●	●	●	●	●	●
		LITE GLASS	050	●				●	●	●
		LITE GLASS +	050	●			●	●	●	●
		UNIKGLASS+ AIR	056	●		●	●	●		
		POCKET GLASS	068	●	●				●	●
		UNIKSELF	082	●				●		
		UNIKAIR SELF	084	●				●		
		KT GLASS	088	●	●			●	●	
		NK GLASS	090	●				●	●	
FRENTE ACRISTALADO + PUERTA CORREDERA DE MADERA/ FIXED GLASS + SLIDING WOODEN DOOR		FRONT	036	●			●		●	●
		LIGNEA	040	●			●		●	
PUERTAS PARALELAS/ BI PASSING DOORS		LITE GLASS+	050	●			●	●	●	●
		LITE GLASS	050	●				●	●	●
		CLOS GLASS	091	●					●	

APLICACIÓN/ APPLICATION	PRODUCTO/ PRODUCT	PÁG./ PAGE	PESO*/ WEIGHT*		FRENO BRAKE			INSTALACIÓN MOUNTING		
			≤100	>100	KBS	KSC	SELF	PARED WALL	TECHO CEILING	EMPOTRABLE RECESSED
PUERTAS TELESCÓPICAS/ TELESCOPIC DOORS		EXTENDO	058	•	•			•	•	•
FRENTE ACRISTALADO + PUERTA CORREDERA/ FIXED GLASS + SLIDING GLASS DOOR		ROLLGLASS+	032	•	•	•	•		•	•
		PANORAMIC	064	•	•				•	•
		ROLLGLASS	070	•	•				•	
		ROLLGLASS AUTOPORTANTE	072	•				•		
		ROLLGLASS SELF	086	•			•		•	
PUERTAS EN ESQUINA/ CORNER DOORS		EXTENDO CORNER	058	•	•			•	•	•
		ROLMATIC CORNER	076	•					•	
		UNIKMATIC CORNER	078	•				•		
PUERTAS ENFRENTADAS/ BI PARTING DOORS		ROLMATIC	076	•					•	
		UNIKMATIC	078	•				•		
		UNIKMATIC AIR	085	•				•		
PUERTAS APILABLES/ STACKABLE DOORS		STOCKGLASS	092	•	•				•	

* Su peso se calcula en base a la siguiente fórmula: Altura [m] x Ancho [m] x Espesor [mm] x 2,5 = Peso [kg]

* The weight is calculated based on the following formula: Height [m] x Width [m] x Thickness [mm] x 2,5 = Weight [kg]



Rollglass+

Rollglass+ crea un frente acristalado que combina paneles de vidrio fijos y móviles mediante una única guía. Puede esconderse en falso techo para un efecto absolutamente minimalista, con un perfil premarco que posibilita una instalación por fases. Versátil y flexible, permite variadas combinaciones y cuida todos los detalles.

Disponible con o sin perfil inferior para el vidrio fijo. Regulable en altura para facilitar la instalación (Rollglass+ 50/100).

Sistema de frenado de la puerta disponibles:

KSC - Klein Soft Closing, detención suave controlada.

KBS - Klein Brake System, tope con freno amortiguador. Disponible para Rollglass+ 50/100.

- Alu. Silver Mate
Alu. Silver Matte
- Alu. Negro Mate
Alu. Black Matte
- Alu. Bronce Mate
Alu. Bronze Matte

Rollglass+ creates a glass front that combines fixed and mobile glass panels on a single track. It can be hidden in a drop ceiling for a completely minimalist effect, with a recessed frame track that allows for a phased installation. Versatile and flexible, it allows for various combinations, and is precise down to the smallest detail.

Available with or without a bottom profile for the fixed glass. Easy installation (for Rollglass+ 50/100).

Door braking systems available:

KSC - Klein Soft Closing, smooth, controlled closing.

KBS - Klein Brake System, stop with damper brake available for Rollglass+ 50/100.

Peso máx./ 150 kg
Max. weight: 330 lbs

Freno/
Brake: KSC
KBS

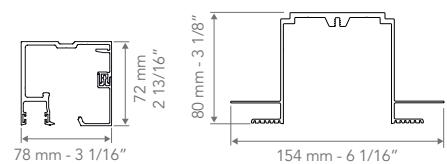



VISTO / EXPOSED

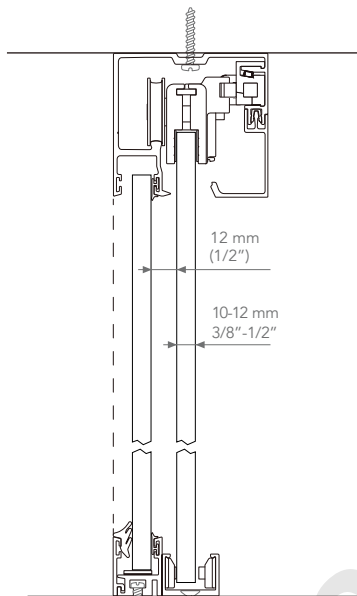

EMPOTRADO / RECESSED

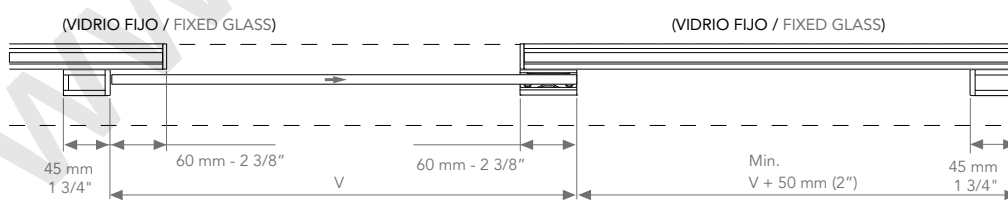
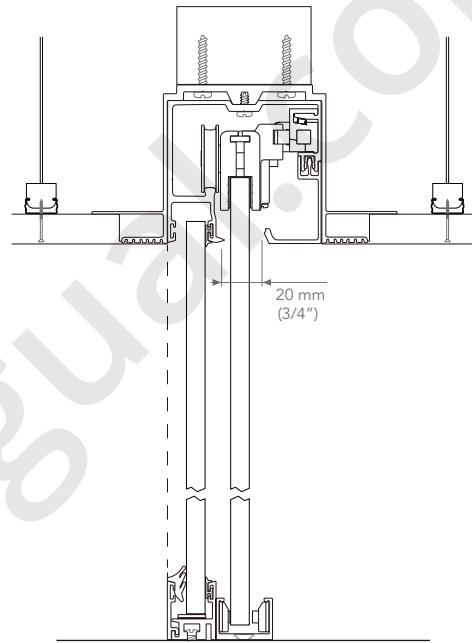

ROLLGLASS+ 50/100 KSC: $V \geq 800$ mm (31 1/2")
 ROLLGLASS+ 150 KSC: $V \geq 1.000$ mm (39")



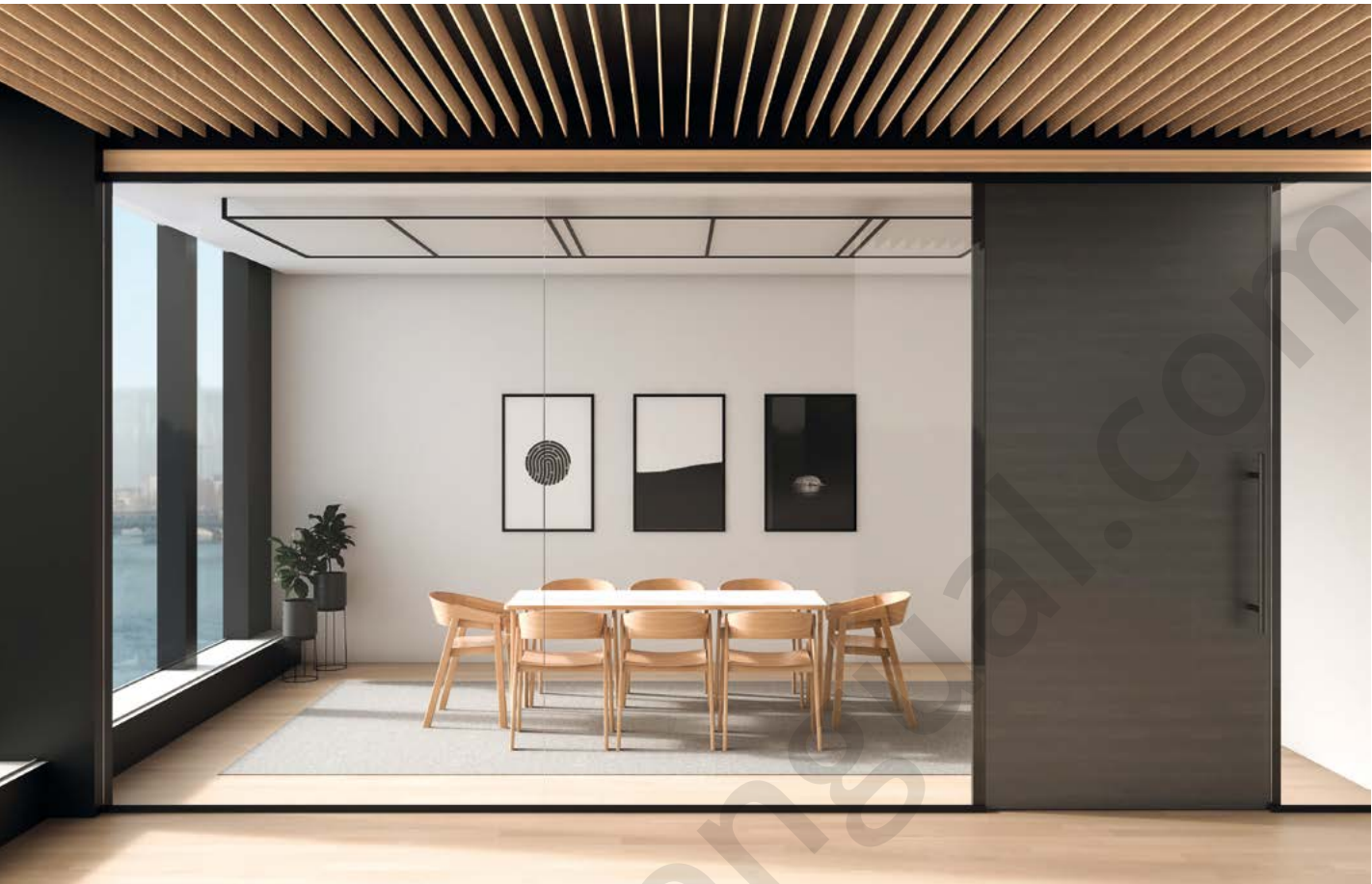

Front

Front estructura los espacios mediante un frente acristalado continuo y elegantes puertas de madera. La belleza del armónico contraste de dos materiales únicos.

Admite cristal fijo de 10 mm y de 12 mm. Puede esconderse en falso techo para potenciar la levedad del conjunto, con un perfil premarco que posibilita una instalación por fases.

Sistema de frenado KSC-Klein Soft Closing, detención suave controlada.

Front structures spaces with a continuous glass front and elegant wood doors. The beauty of the harmonious contrast between two unique materials.

Supports fixed glass measuring 10 mm and 12 mm. It can be hidden in a drop ceiling to accentuate the light nature of the structure, with a recessed frame track that allows for a phased installation.

KSC-Klein Soft Closing braking system, smooth, controlled closing.

- Alu. Silver Mate
Alu. Silver Matte
- Alu. Negro Mate
Alu. Black Matte
- Alu. Bronce Mate
Alu. Bronze Matte

Peso máx./ Max. weight:	100 kg 220 lbs
Freno/ Brake:	KSC

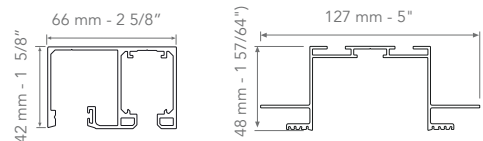

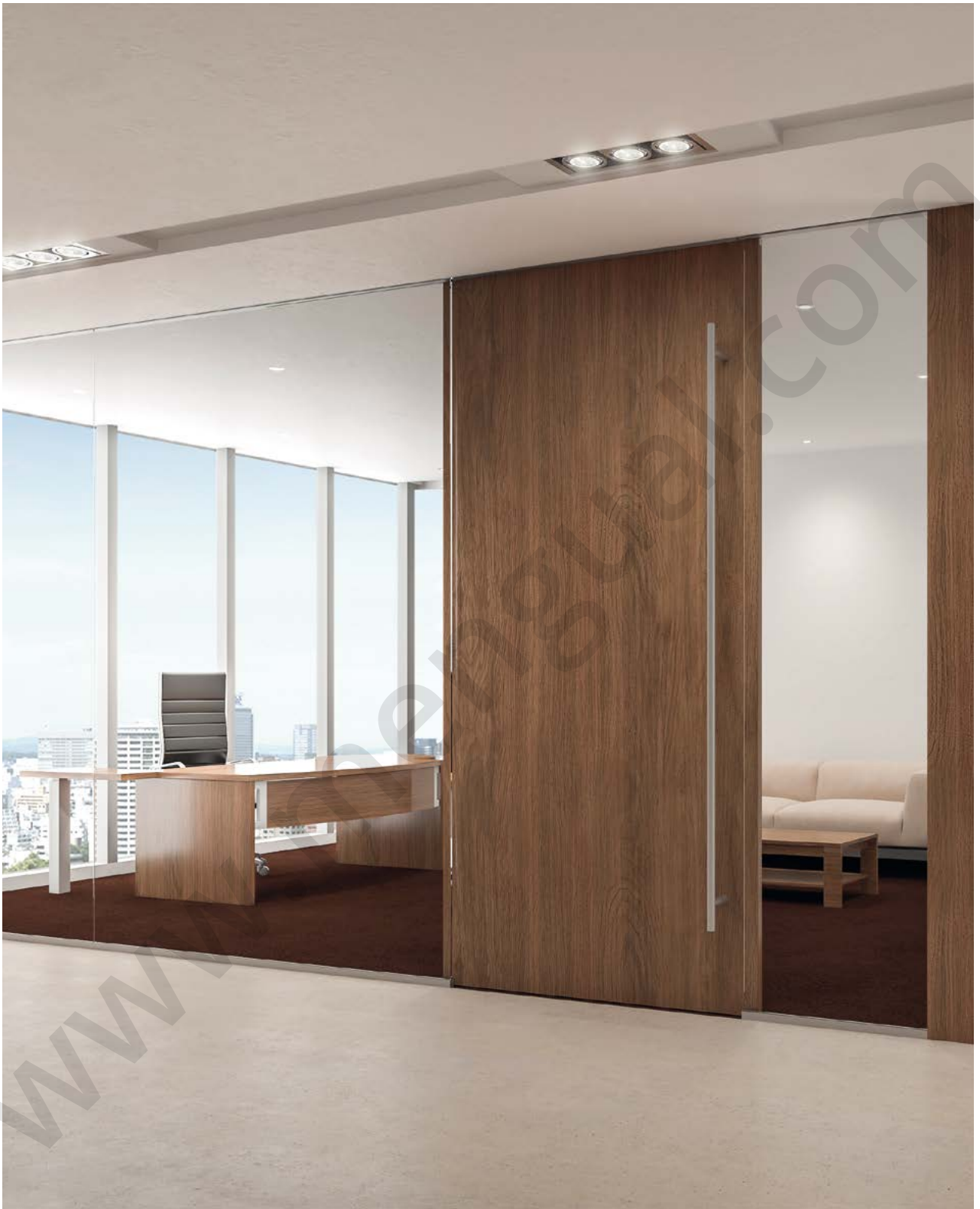

VISTO / EXPOSED

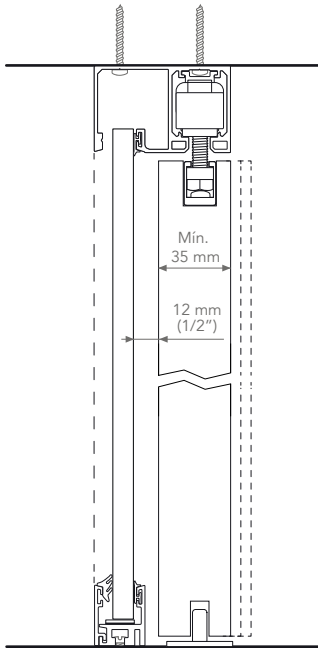

EMPOTRADO / RECESSED

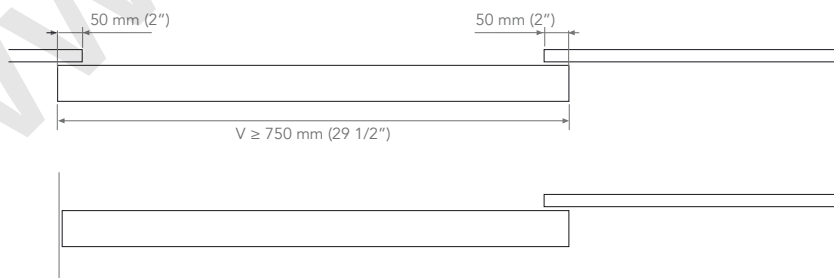
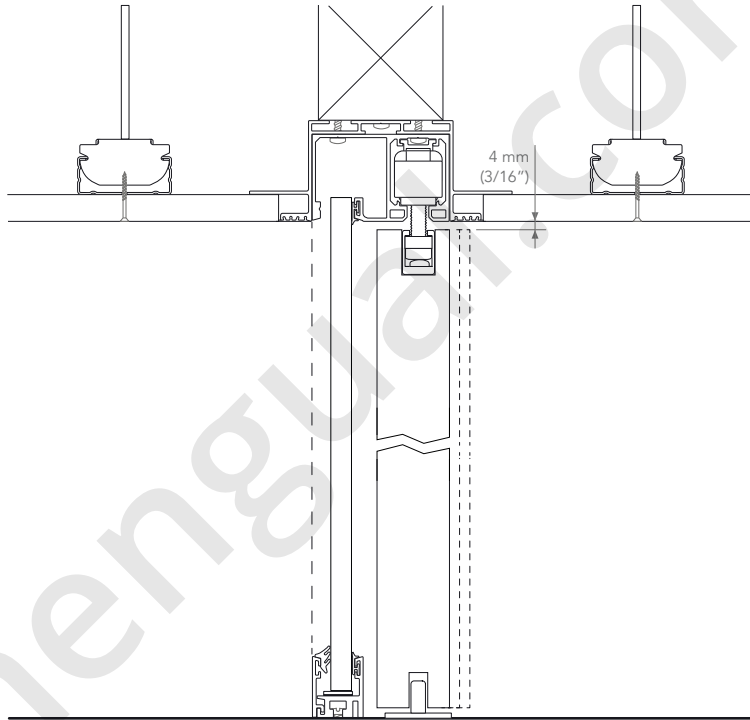





Ligneá

Ligneá genera espacios acristalados mediante una combinación de vidrios fijos con puertas correderas de madera y retornos en L o T para cerramientos completos.

Admite cristal fijo de 12 mm. Todos los detalles cuentan cuando se busca la perfección y la personalización.

Los perfiles verticales y las uniones en T y L están diseñados para facilitar el montaje y resolver con calidad los acabados de los espacios generados.

Sistema de frenado KSC-Klein Soft Closing, detención suave controlada.

Ligneá creates glass spaces through a combination of fixed glass panels and sliding wood doors, as well as L or T closings, for completely enclosed spaces.

Supports fixed glass measuring 12 mm. Every last detail counts when striving for perfection and customization.

Our vertical profiles and T- and L-connectors are designed to facilitate the assembly process and create quality finishes for the spaces generated.

KSC-Klein Soft Closing braking system, smooth, controlled closing.

- Alu. Silver Mate
Alu. Silver Matte
- Alu. Negro Mate
Alu. Black Matte
- Alu. Bronce Mate
Alu. Bronze Matte

Peso máx./ Max. weight:	100 kg 220 lbs
Freno/ Brake:	KSC

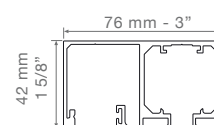



VISTO / EXPOSED

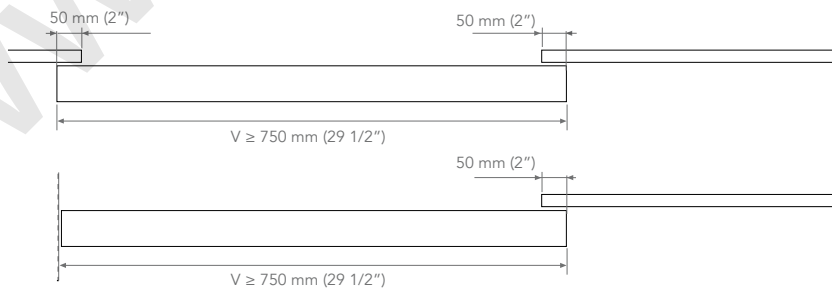
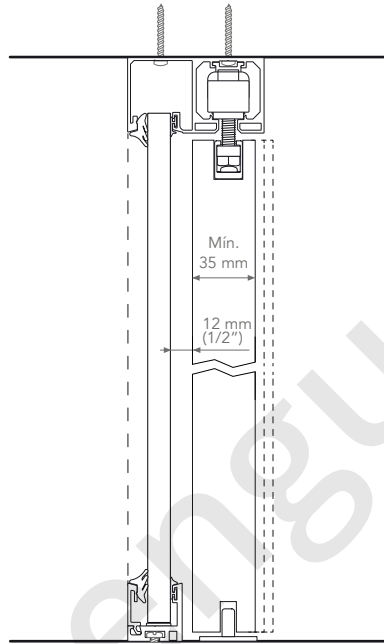







NEW! Ligneia | Interiorismo Vidrio - Glass Interior Design



Unikglass+

Unikglass+ conecta estancias mediante un único panel corredero de cristal. Sobrio y discreto, ahorra espacio y suma modernidad. Puede esconderse en falso techo para un efecto absolutamente minimalista, con un perfil pre-marco que posibilita una instalación por fases. La belleza de la sencillez.

Regulable en altura para facilitar la instalación (Unikglass+ 50/100).

Sistema de frenado de la puerta disponibles:

KSC - Klein Soft Closing, detención suave controlada.

KBS - Klein Brake System, tope con freno amortiguador. Disponible para Unikglass+ 50/100.

Unikglass+ connects rooms with a single sliding glass panel. Restrained and discreet, it saves space and adds modernity. It can be hidden in a drop ceiling for a completely minimalist effect, with a recessed frame track profile that allows for a phased installation. The beauty of simplicity.

Easy installation (for Unikglass+ 50/100).

Door braking systems available:

KSC - Klein Soft Closing, smooth, controlled closing.

KBS - Klein Brake System, stop with damper brake available for Unikglass+ 50/100

- Alu. Silver Mate
Alu. Silver Matte
- Alu. Negro Mate
Alu. Black Matte
- Alu. Bronce Mate
Alu. Bronze Matte

Peso máx./ Max. weight:	150 kg 330 lbs
Freno/ Brake:	KSC KBS

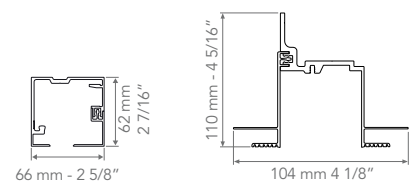



VISTO / EXPOSED

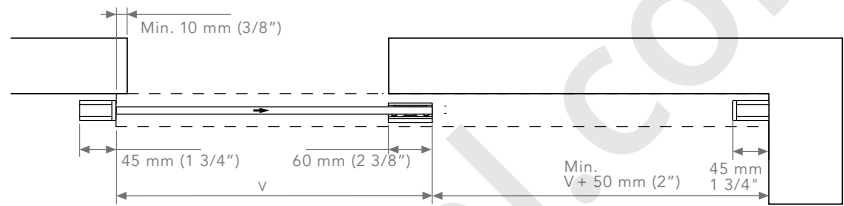
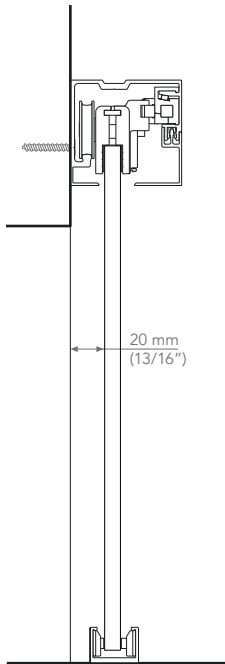

UNIKGLASS+ 50/100 KSC: $V \geq 800$ mm (31 1/2")
 UNIKGLASS+ 150 KSC: $V \geq 1.000$ mm (39")

EMPOTRADO / RECESSED

CON DINTEL / WITH LINTEL

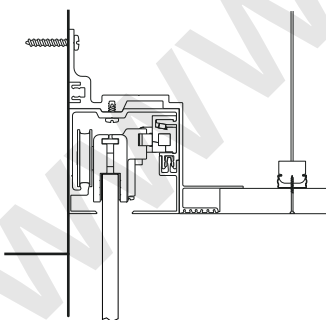

SIN DINTEL / WITHOUT LINTEL

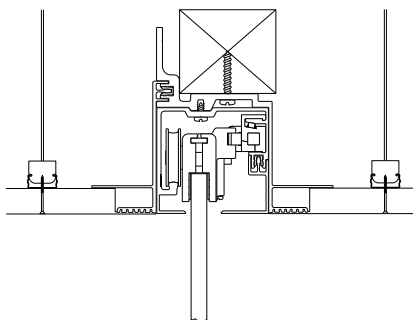

SIN DINTEL / WITHOUT LINTEL

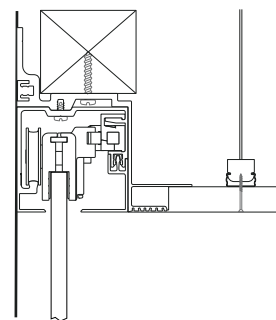





Lite Glass / Lite Glass+

La línea **Lite Glass/Lite Glass+** conecta estancias mediante una puerta corredera. Ofrece numerosas configuraciones tales como puertas paralelas o enfrentadas.

Su perfil Top permite empotrar el perfil a falso techo.

Sistema de frenado opcional con Lite Glass+ 100: **KSC** - Klein Soft Closing, detención suave controlada.

The **Lite Glass/Lite Glass+** line connects rooms with a sliding door. It offers numerous configurations, such as bi-passing or bi-parting doors.

Its Top profile allows the profile to be recessed in a drop ceiling.

Optional braking system with Lite Glass+ 100: **KSC** - Klein Soft Closing, smooth, controlled closing.

- Alu. Silver Mate
Alu. Silver Matte
- Alu. Negro Mate
Alu. Black Matte
- Alu. Bronce Mate
Alu. Bronze Matte

Peso máx./ 100 kg
Max. weight: 220 lbs

Freno/
Brake: KSC

LITE GLASS 60

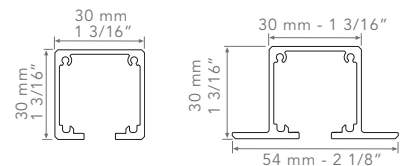

LITE GLASS / LITE GLASS+ 100

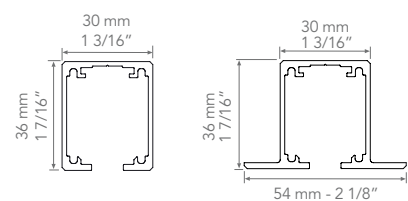



LITE GLASS 60

PERFIL TOP / TOP TRACK

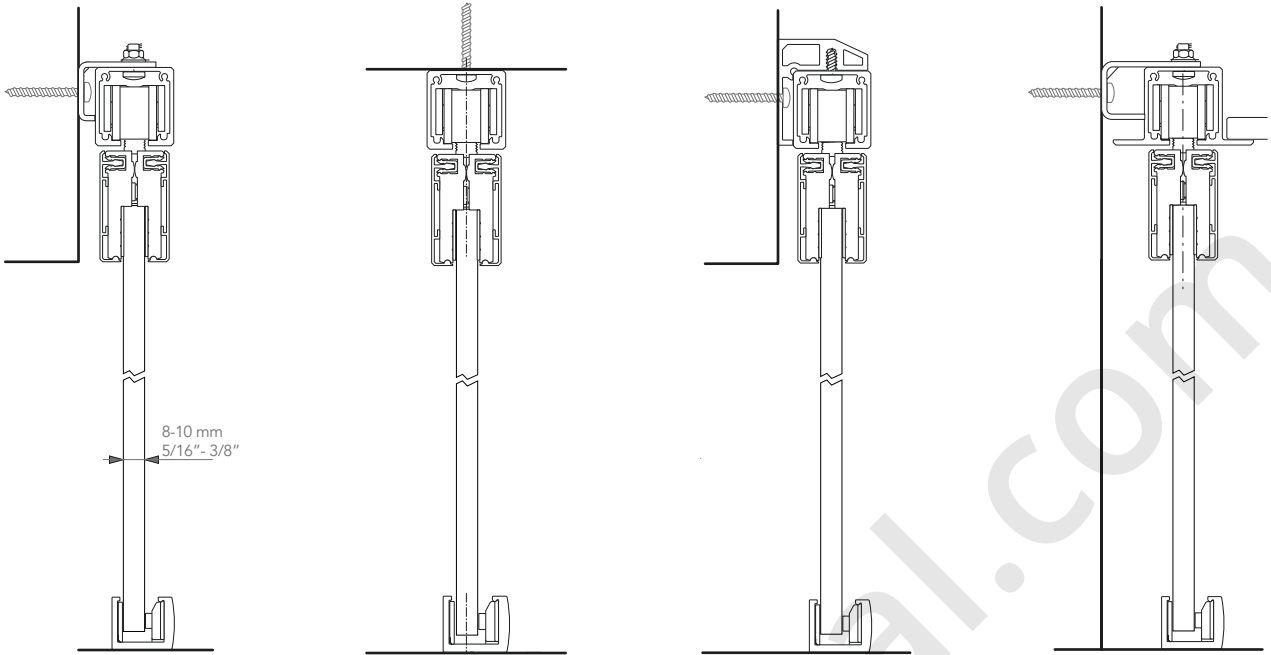

Soporte pared 6 mm /
Wall bracket 6 mm

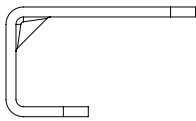

Soporte pared 17 mm /
Wall bracket 17mm

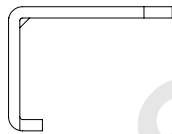

Perfil soporte pared 6 mm /
Wall bracket profile 6 mm

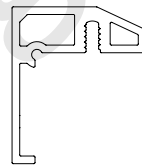

Perfil soporte pared 17 mm /
Wall bracket profile 17 mm

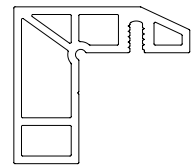

LITE GLASS / LITE GLASS+ 100

PERFIL TOP / TOP TRACK

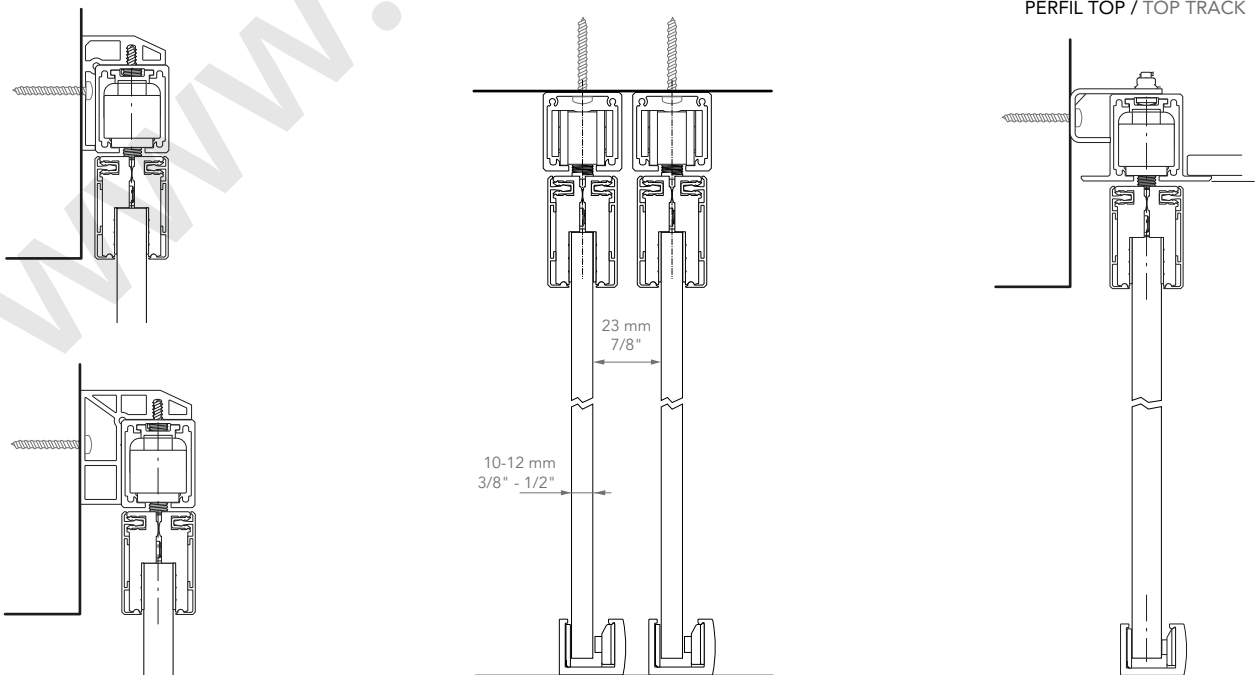







Extendo | Interiorismo Vidrio - Glass Interior Design



Unikglass+ Air

Unikglass+ Air está diseñado para ser instalado sobre una pared de cristal, potenciando así la difusión de la luz natural. Es particularmente adecuado para estancias con techos altos y oficinas. Transparencia absoluta.

Instalación sobre pared de vidrio de 10 y 12 mm. Regulable en altura para facilitar la instalación.

Sistema de frenado de la puerta, a escoger:
KSC - Klein Soft Closing, detención suave controlada.

KBS - Klein Brake System, tope con freno amortiguador.

Unikglass+ Air is designed to be installed on a glass wall, boosting the diffusion of natural light. It is particularly well suited for offices and rooms with high ceilings. Total transparency.

Installation on 10 mm and 12 mm glass wall. Height adjustable for easy installation.

Door braking system, to be chosen from the following options:

KSC - Klein Soft Closing, smooth, controlled closing.

KBS - Klein Brake System, stop with damper brake.

● Alu. Silver Mate
 Alu. Silver Matte

● Alu. Negro Mate
 Alu. Black Matte

Peso máx./ variable
 Max. weight:

Freno/ KSC
 Brake: KBS

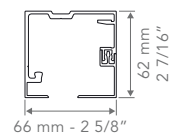

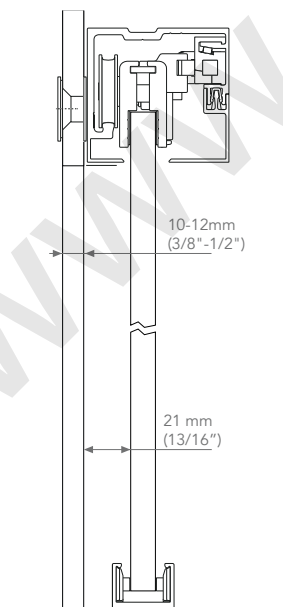

Gama	Perfil / Track	L
G1	2 m - 78 3/4"	Min. 820 mm Max. 970 mm Min. 32 5/16" Max. 38 3/16"
G2	2,5 m - 98 3/8"	Min. 1.020 mm Max. 1.220 mm Min. 40 3/16" Max. 48"
G3	3 m - 118 1/8"	Min. 1.300 mm Max. 1.470 mm Min. 51 3/16" Max. 57 7/8"

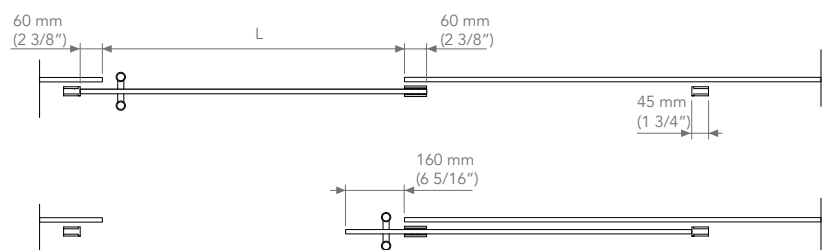



Extendo / Extendo Corner

Extendo está diseñado para crear espacios mediante un sistema de 2, 3 o 4 paneles correderos telescópicos y sincrónicos de cristal. Al mover una sola hoja, se genera el suave deslizamiento de las demás, sin esfuerzo. Particularmente adecuado para proyectos contemporáneos, permite una luz de paso de hasta 5,10 m. Su sistema de transmisión viene premontado de fábrica para agilizar el montaje.

Está también disponible en aplicación Corner, ideal para crear una estancia dentro de un espacio existente.

Extendo is designed to create spaces with a system of 2, 3 or 4 telescopic and synchronized sliding glass panels. When one sheet is moved, the others smoothly and effortlessly slide along with it. Particularly well suited to contemporary projects, it allows for passageways measuring up to 5.10 meters. Its transmission system comes pre-assembled from the factory to speed up the installation process.

It is also available as a corner application, perfect for creating a room within an existing space.

- Alu. Silver Mate
- Alu. Silver Matte

Peso máx./ variable
Max. weight:

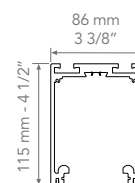



SIN VIDRIO FIJO / WITHOUT FIXED GLASS

CON VIDRIO FIJO / WITH FIXED GLASS

EMPOTRADO / RECESSED

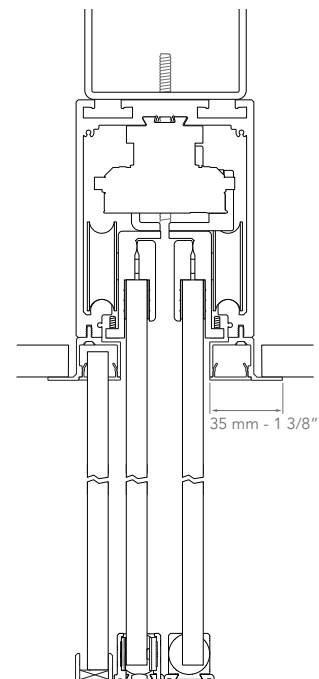
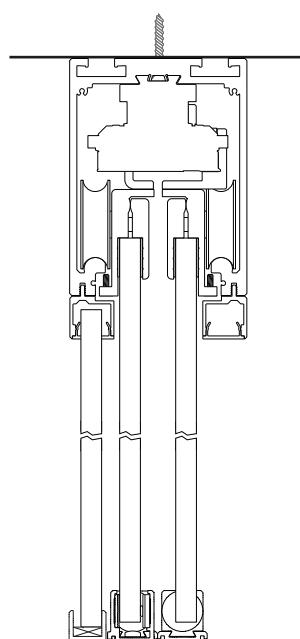
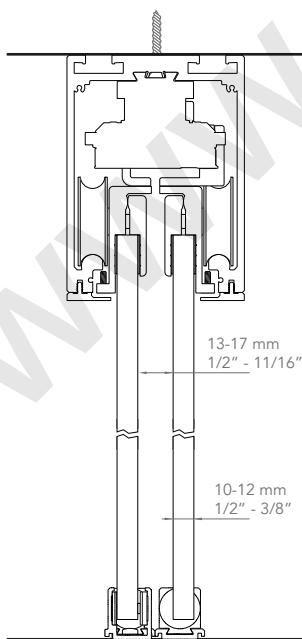

EXTENDO 2

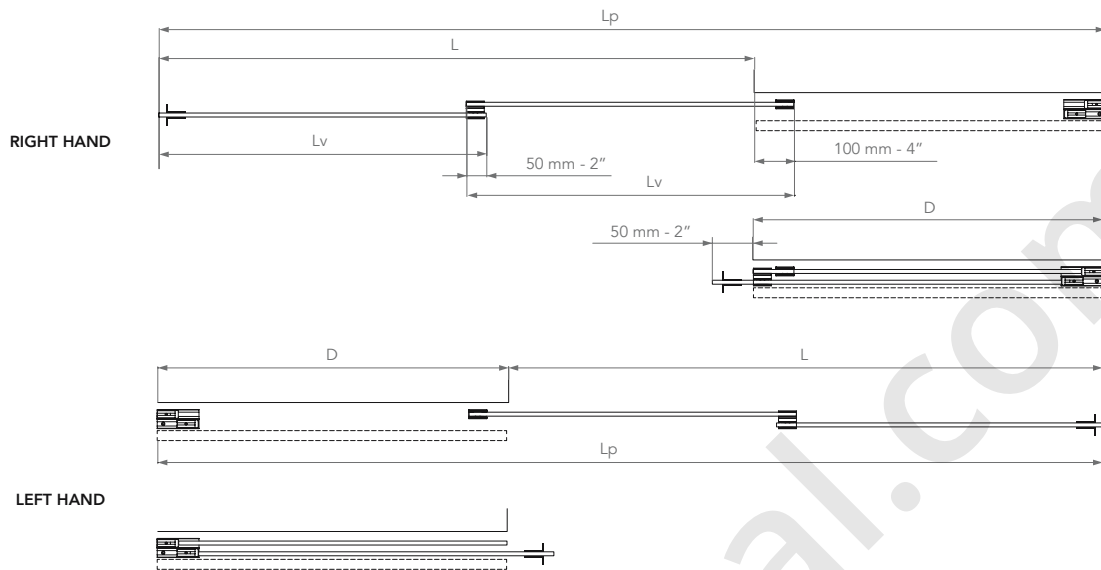

L	Perfil / Track	Altura vidrio / Glass height
1.250-1.550 mm (4' 1" - 5' 1")	2.500 mm (98")	≤ 3.000 mm (10')
1.550-1.900 mm (5' 1" - 6' 3")	3.000 mm (118")	≤ 3.000 mm (10')
1.900-2.200 mm (6' 3" - 7' 3")	3.500 mm (137")	≤ 3.000 mm (10')
2.200-2.550 mm (7' 3" - 8' 4")	4.000 mm (157")	≤ 3.000 mm (10')

$L \leq \frac{2}{3} P - 85 \text{ mm (3 3/8")}$	$D \geq \frac{P}{3} + 85 \text{ mm (3 3/8")}$	$D \geq \frac{L}{2} + 125 \text{ mm (5")}$	$P = L + D$	$Lv = \frac{L}{2} + 75 \text{ mm (3")}$
---	---	--	-------------	---

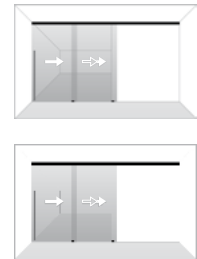

EXTENDO 2+2

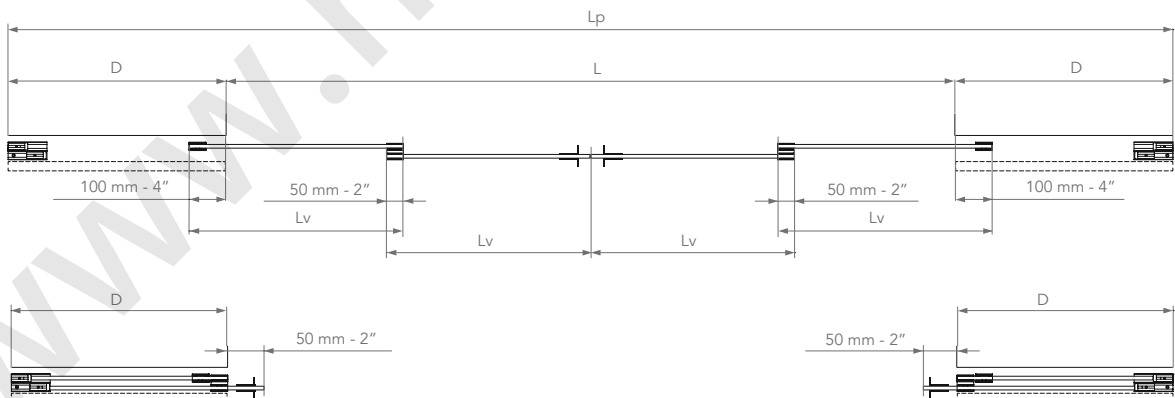

L	Perfil / Track	Altura vidrio / Glass height
2.500-3.100 mm (8' 2" - 10' 2")	2.500 mm (98") x 2	≤ 3.000 mm (10')
3.100-3.800 mm (10' 2" - 12' 6")	3.000 mm (118") x 2	≤ 3.000 mm (10')
3.800-4.400 mm (12' 6" - 14' 5")	3.500 mm (137") x 2	≤ 3.000 mm (10')
4.400-5.100 mm (14' 5" - 16' 9")	4.000 mm (157") x 2	≤ 3.000 mm (10')

$L \leq \frac{2}{3} P - 170 \text{ mm (6 11/16")}$	$D \geq \frac{P}{6} + 85 \text{ mm (3 3/8")}$	$D \geq \frac{L}{4} + 125 \text{ mm (5")}$	$P = Dx2 + L$	$Lv = \frac{L}{4} + 75 \text{ mm (3")}$
--	---	--	---------------	---

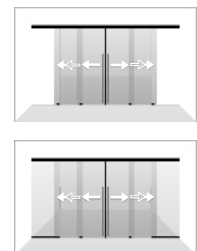

EXTENDO 3

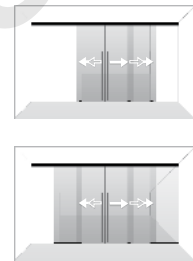
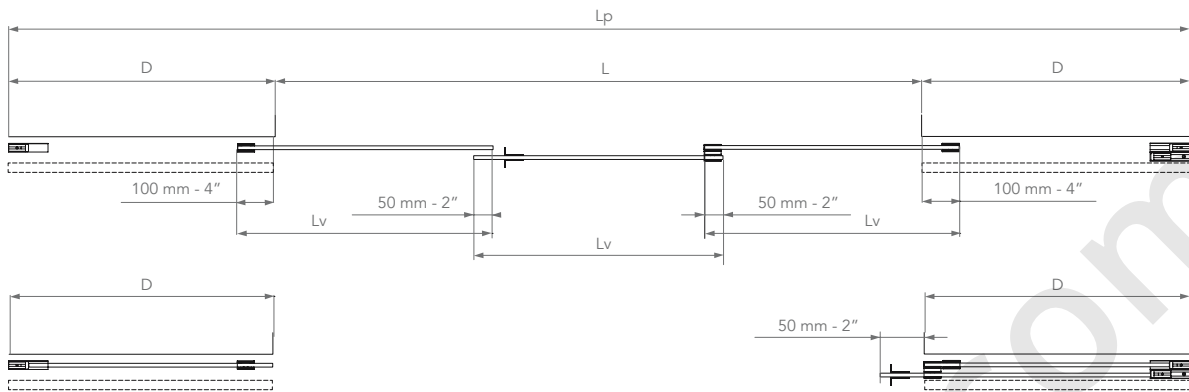

L	Perfil / Track	Altura vidrio / Glass height
1.725-2.175 mm (5' 8" - 7' 2")	4.000 mm (157")	$\leq 3.000\text{ mm}$ (10')
2.175-2.775 mm (7' 2" - 9' 1")	5.000 mm (196")	$\leq 3.000\text{ mm}$ (10')

$L \leq \frac{3}{5} P - 180\text{ mm}$ (7 1/6")	$D \geq \frac{P}{5} + 90\text{ mm}$ (3 9/16")	$D \geq \frac{L}{3} + 150\text{ mm}$ (5 15/16")	$P = D \times 2 + L$	$L_v = \frac{L}{3} + 100\text{ mm}$ (4")
---	---	---	----------------------	--

EXTENDO 4

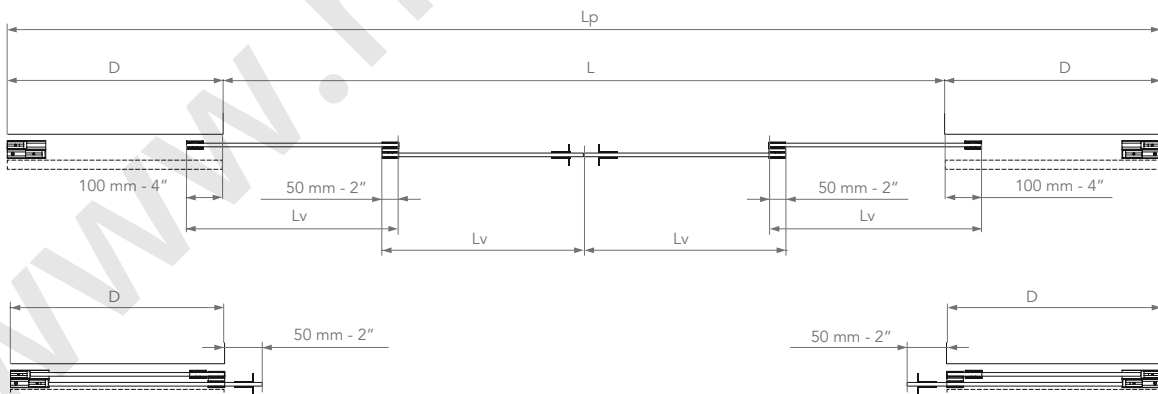

L	Perfil / Track	Altura vidrio / Glass height
2.400-3.100 mm (7' 10" - 10' 2")	5.000 mm (196")	$\leq 3.000\text{ mm}$ (10')

$L \leq \frac{2}{3} P - 170\text{ mm}$ (6 11/16")	$D \geq \frac{P}{6} + 85\text{ mm}$ (3 3/8")	$D \geq \frac{L}{4} + 125\text{ mm}$ (5")	$P = D \times 2 + L$	$L_v = \frac{L}{4} + 75\text{ mm}$ (3")
---	--	---	----------------------	---

EXTENDO CORNER

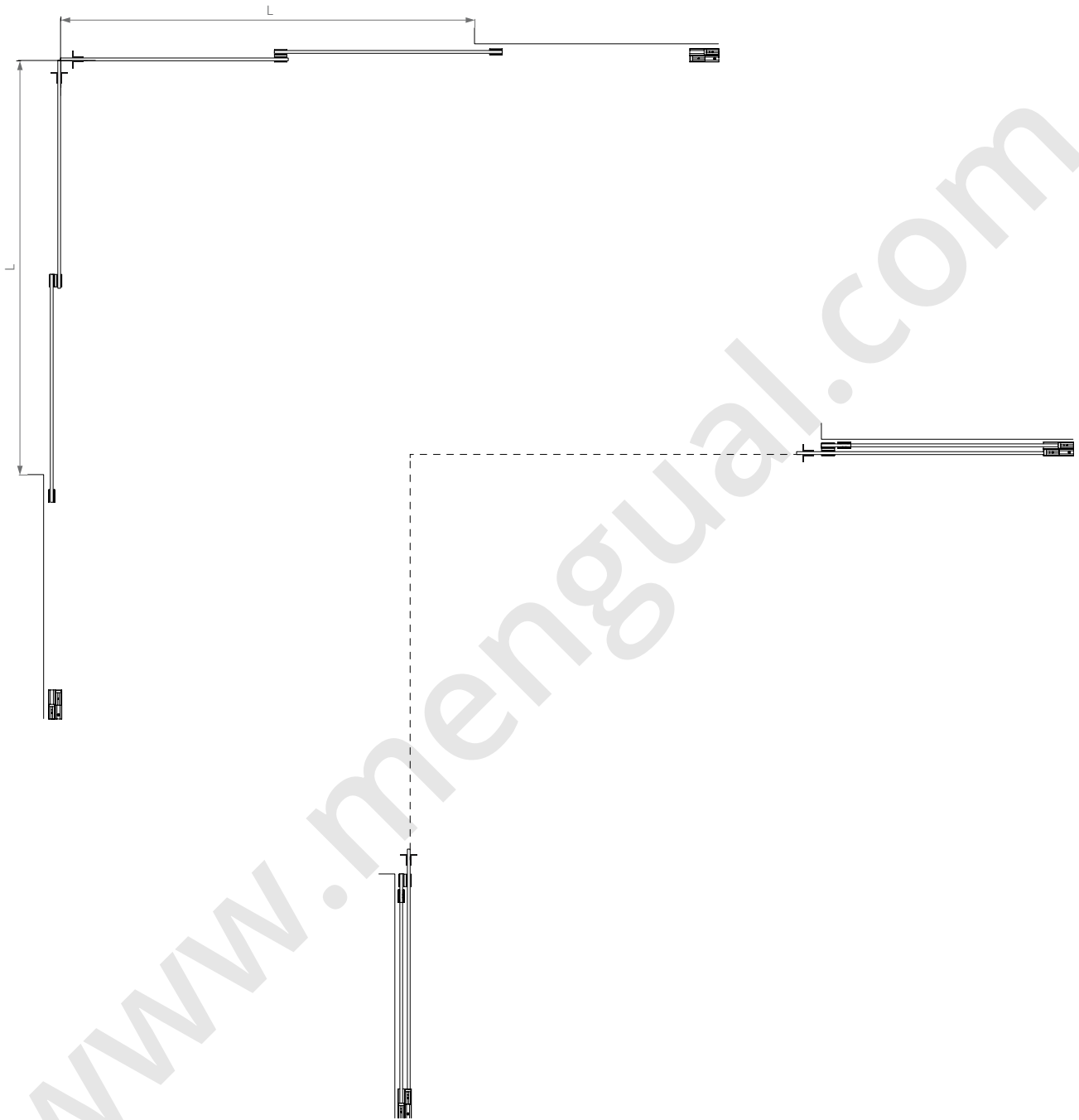

L	Perfil / Track	Altura vidrio / Glass height
1.250-1.550 mm (4' 1" - 5' 1")	2.500 mm (98") x 2	≤ 3.000 mm (10')
1.550-1.900 mm (5' 1" - 6' 3")	3.000 mm (118") x 2	≤ 3.000 mm (10')
1.900-2.200 mm (6' 3" - 7' 3")	3.500 mm (137") x 2	≤ 3.000 mm (10')
2.200-2.550 mm (7' 3" - 8' 4")	4.000 mm (157") x 2	≤ 3.000 mm (10')

$L \leq \frac{2}{3} P - 85 \text{ mm (3 3/8")}$	$D \geq \frac{P}{3} + 85 \text{ mm (3 3/8")}$	$D \geq \frac{L}{2} + 125 \text{ mm (5")}$	$P = L + D$	$L_v = \frac{L}{2} + 75 \text{ mm (3")}$
---	---	--	-------------	--

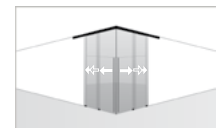
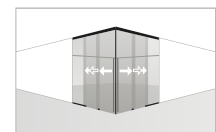





Panoramic

Panoramic es un sistema de frente acristalado de máxima calidad, diseñado para crear o reorganizar espacios interiores. Permite una gran flexibilidad de aplicaciones y ofrece prestaciones como retorno a 90° o perfilería superior e inferior empotrables. También tiene la posibilidad de doble vidrio fijo, de 12 ó 16 mm.

Incorpora juntas aislantes para una mayor privacidad.
Posibilidad de perfiles de falso techo para instalación por fases.
Otorga al arquitecto máxima libertad de diseño.

Panoramic is a glass front system of the highest quality, designed to create or reorganize interior spaces. It allows for a wide range of applications and offers features such as a 90° junction or recessed top and bottom profiles. It also offers the possibility of double fixed glass, measuring 12 mm or 16 mm.

It incorporates insulating joints for greater privacy.
Possibility of drop-ceiling profiles for phased installation.
It gives the architect maximum freedom when designing.

● Alu. Silver Mate
Alu. Silver Matte

Peso máx./ 120 kg
Max. weight: 264 lbs

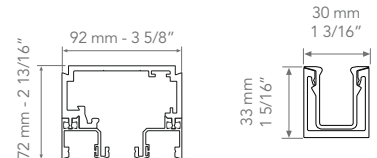



DOBLE VIDRIO FIJO / DOUBLE FIXED GLAZING

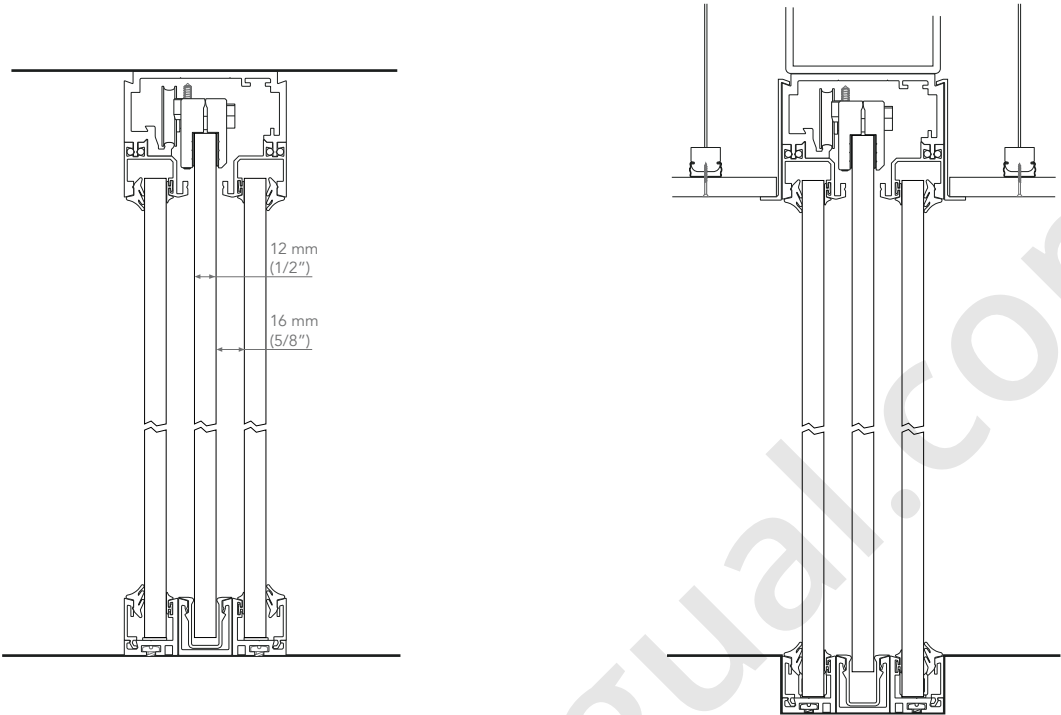

UN VIDRIO FIJO / SINGLE FIXED GLAZING

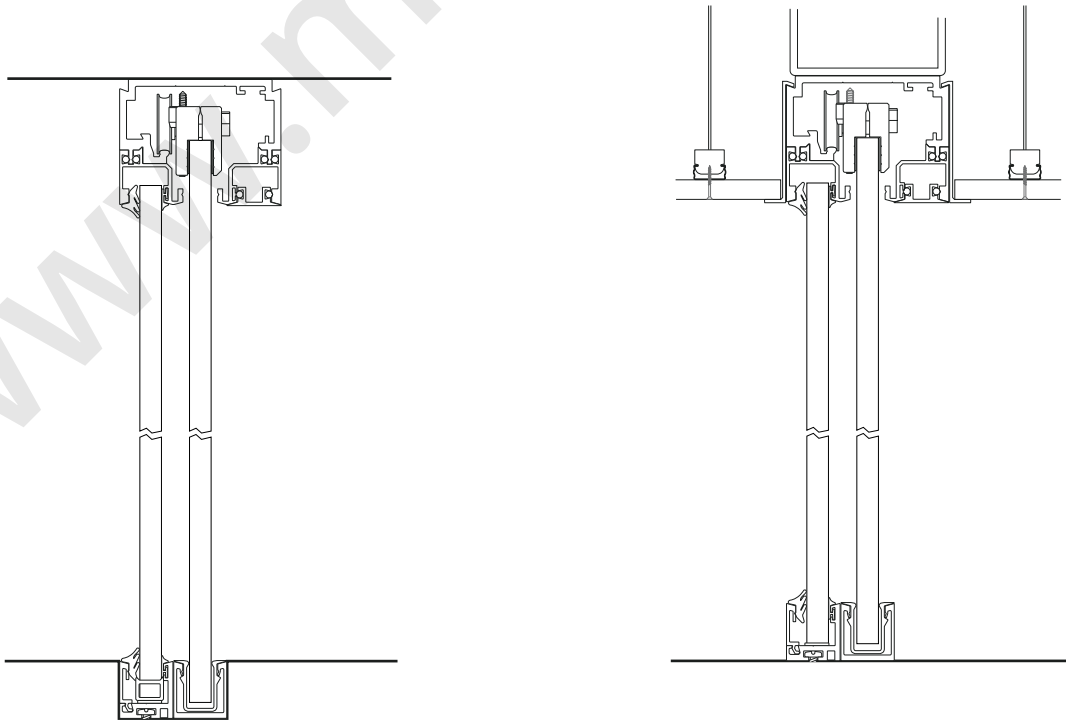

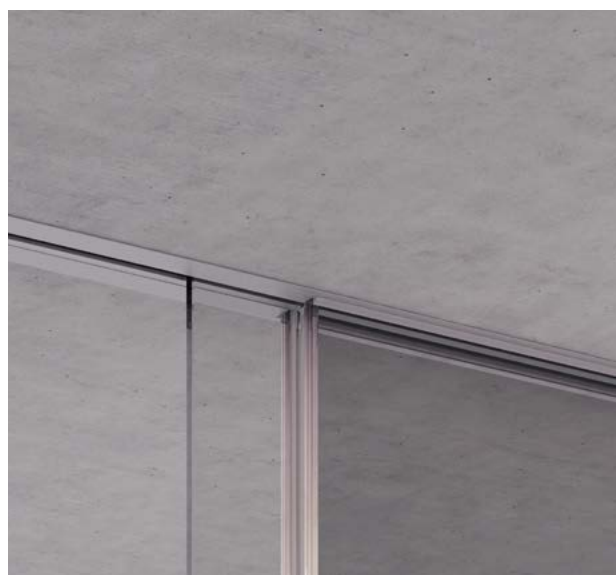



Pocket Glass

Pocket Glass está diseñado para conectar ambientes a través de una o varias puertas correderas de cristal, con perfil empotrado o visto.

Dos versiones dejan patente su versatilidad: un diseño limpio, sin ningún herraje a la vista, y un diseño comercial, con mordazas expuestas.

Sistema de sujeción de la puerta a escoger: mediante mordazas de presión cortas o largas.

Pocket Glass is designed to connect rooms with one or several sliding glass doors, with a recessed or exposed profile.

Two versions make its versatility clear: a clean design, without any fittings in sight, and a commercial design, with exposed clamps.

Door fastening system to be chosen from the following: short or long pressure clamps.

- Alu. Silver Mate
- Alu. Silver Matte

Peso máx./ 150 kg
Max. weight: 330 lbs

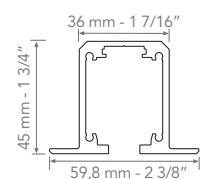
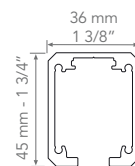



VISTO / EXPOSED

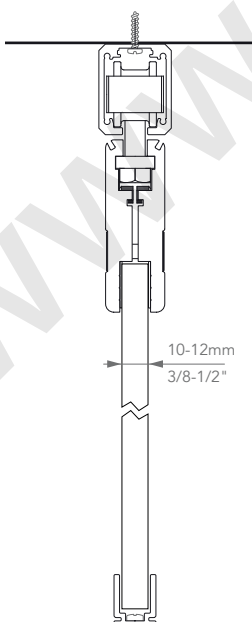

EMPOTRADO / RECESSED

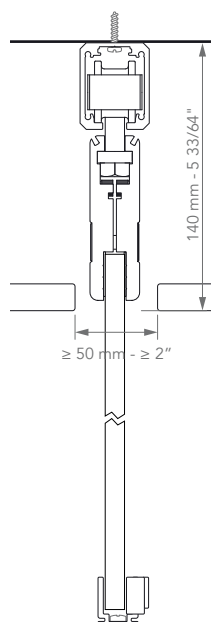

EMPOTRADO / RECESSED
PERFIL TOP / TOP TRACK

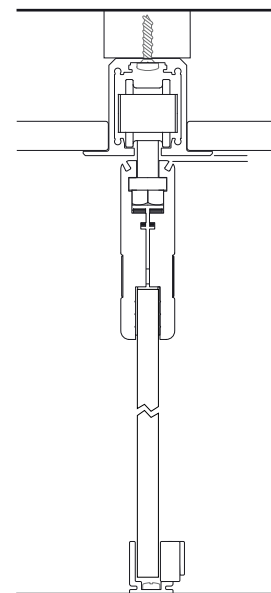



Rollglass

Rollglass crea espacios mediante un frente acristalado que combina paneles fijos y correderos en un único perfil, reafirmando así la sencillez de la instalación y minimizando el espacio entre hoja corredera y vidrio fijo.

Disponible con o sin perfil inferior para el vidrio fijo.

Rollglass creates spaces with a glass front that combines fixed and sliding panels on a single profile, resulting in a simple installation and minimizing the gap between the fixed and sliding glass panels.

Available with or without a bottom profile for the fixed glass.

- Alu. Silver Mariner
- Alu. Silver Mariner

Peso máx./ 175 kg
Max. weight: 386 lbs

ROLLGLASS 40

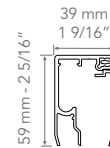

**ROLLGLASS 135
EXPERT**

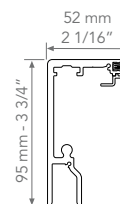

**ROLLGLASS 175
EXPERT**

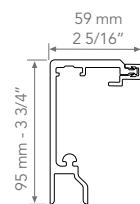



ROLLGLASS 40

ROLLGLASS 135 EXPERT

ROLLGLASS 175 EXPERT

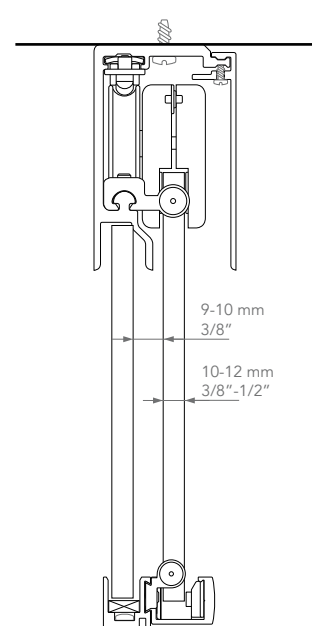
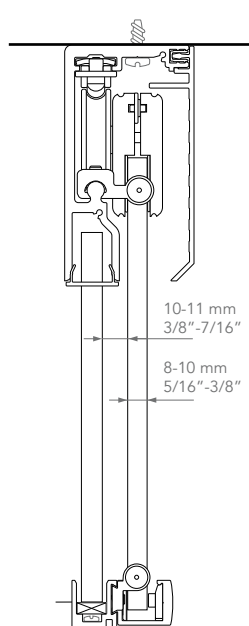
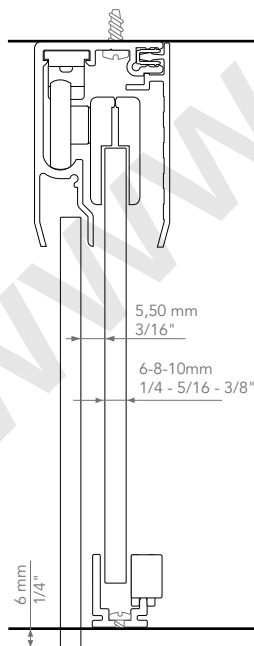



Rollglass Autoportante

Rollglass Autoportante se fija en paredes paralelas y divide espacios mediante un frente acristalado que combina panel fijo y puerta corredera. La mínima separación entre vidrio fijo y corredero aumenta la estética del conjunto.

Su versión Expert resulta ideal en aplicaciones para duchas debido a su guiador especial.

Rollglass Self-Supporting (Autoportante) attaches to parallel walls and divides spaces with a glass front that combines fixed panels and sliding doors. The minimal gap between the fixed and sliding glass strengthens the structure's aesthetic.

Given its special guide, the Expert version is ideal for applications in showers.

- Alu. Silver Mate
- Alu. Silver Matte

Peso máx./ 90 kg
Max. weight: 200 lbs

RG AUTO 40

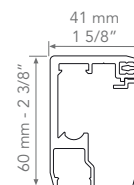

RG AUTO 60/90

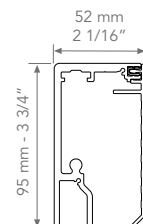



40 BASIC

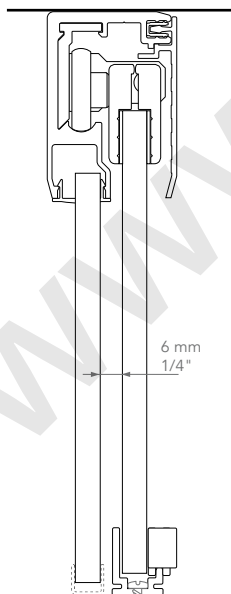

40 EXPERT A

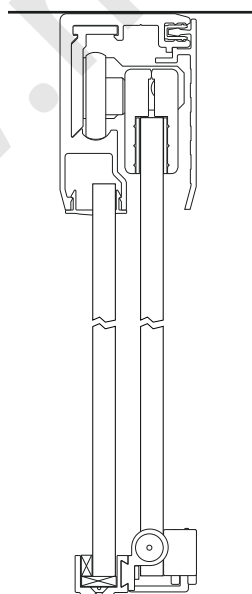

40 EXPERT B

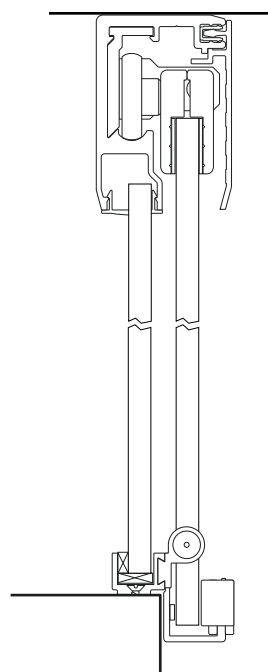

60/90 EXPERT

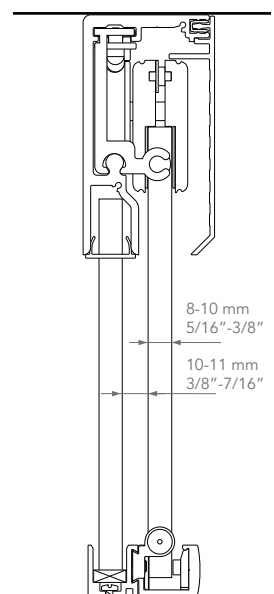



Rollglass Self | Interiorismo Vidrio - Glass Interior Design





Rolmatic / Rolmatic Corner

Rolmatic crea espacios mediante un frente acristalado con dos puertas enfrentadas sincronizadas que se deslizan sobre vidrios fijos. Existe en aplicación Corner.

La mínima separación entre cristal fijo y corredero realza el diseño minimalista del conjunto. Ofrece una luz de paso de hasta 2,50 metros. Su sistema de transmisión premontado garantiza un montaje fácil. Movimiento preciso sin ajuste de sincronización.

Rolmatic creates spaces using a glass front with two synchronized bi-parting doors that slide over fixed glass panels. It is also available as a corner application.

The minimal gap between the fixed and sliding glass enhances the minimalist design of the structure. It offers a passageway measuring up to 2.50 meters. Its pre-assembled transmission system guarantees an easy assembly. Precise movement without any synchronization adjustment.

- Alu. Silver Mate
- Alu. Silver Matte

Peso máx./ variable
Max. weight:

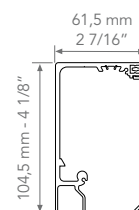

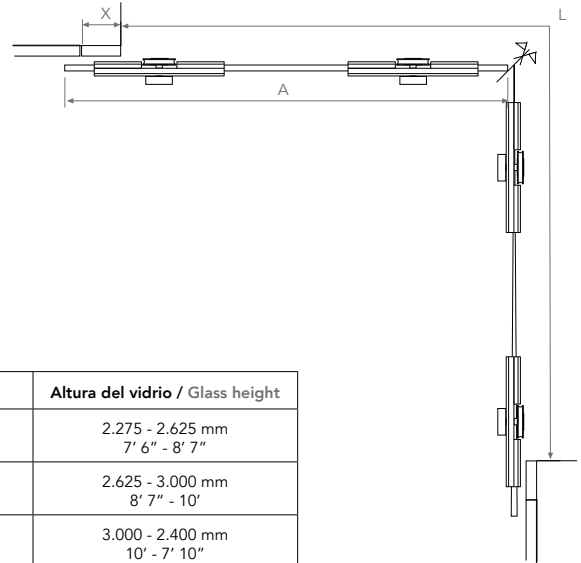
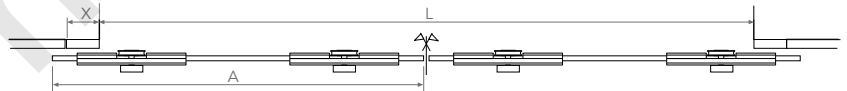
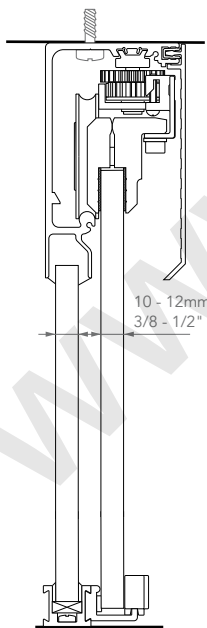

Gama	Perfil / Track	A	Altura del vidrio / Glass height
G1	3.000 mm 118"	650 - 750 mm 25 1/2" - 29 1/2"	2.275 - 2.625 mm 7' 6" - 8' 7"
G2	4.000 mm 157"	750 - 1.000 mm 29 1/2" - 39 1/2"	2.625 - 3.000 mm 8' 7" - 10'
G3	5.000 mm 196"	1.000 - 1.250 mm 39 1/2" - 49"	3.000 - 2.400 mm 10' - 7' 10"



Unikmatic / Unikmatic Corner

Unikmatic conecta ambientes mediante dos paneles correderos enfrentados de cristal, que se deslizan simultáneamente de cada lado al accionar uno de ellos.

Existe en aplicacion Corner.

Permite conseguir una apertura de hasta 2,50 m.

Su sistema de transmisión premontado garantiza un montaje rápido. Movimiento preciso sin ajuste de sincronización.

Unikmatic connects rooms with two bi-parting sliding glass panels that simultaneously slide to either side when one of them is moved.

It is also available as a corner application.

It allows you to achieve an opening of up to 2.50 meters.

Its pre-assembled transmission system guarantees a quick assembly. Precise movement without any synchronization adjustment.

● Alu. Silver Mate
Alu. Silver Matte

Peso máx./ variable
Max. weight:

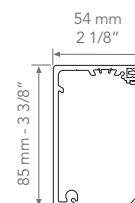

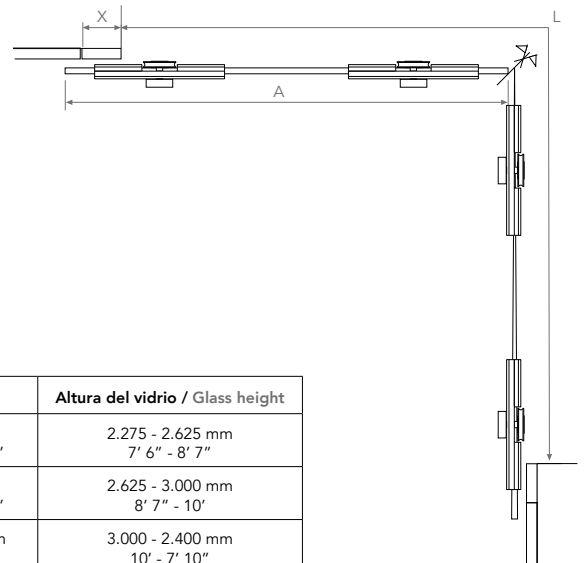
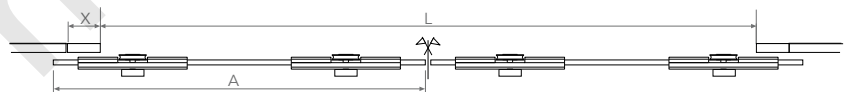
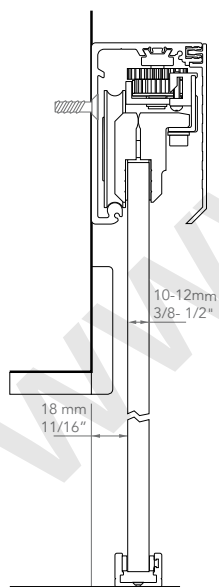

Gama	Perfil / Track	A	Altura del vidrio / Glass height
G1	3.000 mm 118"	650 - 750 mm 25 1/2" - 29 1/2"	2.275 - 2.625 mm 7' 6" - 8' 7"
G2	4.000 mm 157"	750 - 1.000 mm 29 1/2" - 39 1/2"	2.625 - 3.000 mm 8' 7" - 10'
G3	5.000 mm 196"	1.000 - 1.250 mm 39 1/2" - 49"	3.000 - 2.400 mm 10' - 7' 10"

www.menggual.com







Unikself

Unikself conecta espacios mediante un panel corredero de cristal con autocierre avanzado "self closing", de velocidad constante y controlada. Su galería clipada y el sistema de transmisión premontado aseguran una fácil instalación.

Unikself connects spaces through a sliding glass panel with an advanced self-closing feature, which operates at a steady, controlled speed. Its clipped valance and pre-assembled transmission system ensure an easy installation.

- Alu. Silver Mate
- Alu. Silver Matte

Peso máx./	variable
Max. weight:	

Freno/	SELF
Brake:	

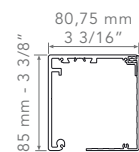

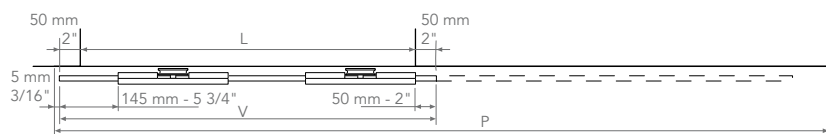
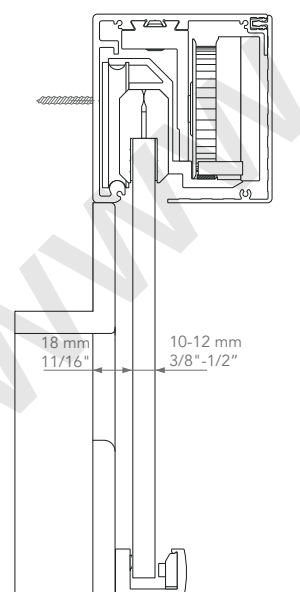

Gama	L	V	P0	P
G1	900 mm - 1.150 mm 35 1/2" - 45"	L + 100 mm L + 4"	2.500 mm 98"	2L + 160 mm 2L + 6 5/16"
G2	1.150 mm - 1.500 mm 45" - 59"		3.000 mm 118"	



Unikair Self

Unikair Self conecta espacios mediante un sistema fijado a una pared de cristal, guiando una puerta corredera de vidrio con autocierre avanzado, de velocidad constante y controlada.

Sistema de transmisión premontado que asegura una instalación fácil. Máxima transparencia y modernidad.

Unikair Self connects spaces with a system attached to a glass wall, guiding a sliding glass door with an advanced self-closing feature, which operates at a study, controlled speed.

Pre-assembled transmission system ensures an easy installation. Maximum transparency and modernity.

- Alu. Silver Mate
Alu. Silver Matte

Peso máx./ variable
Max. weight:

Freno/ SELF
Brake:

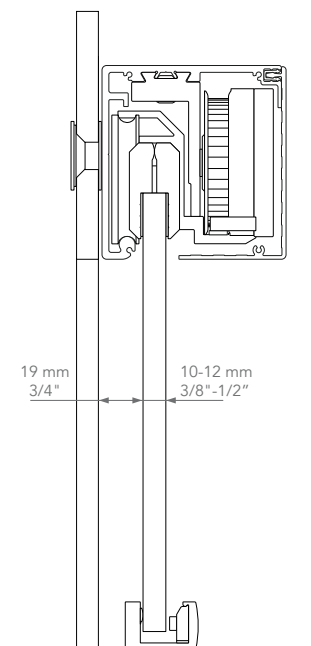
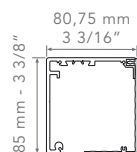



Unikmatic Air

Unikmatic Air crea espacios mediante un sistema fijado a una pared de cristal que guía dos paneles de vidrio correderos enfrentados con apertura sincrónica, de manera que se deslicen simultáneamente hacia cada lado. Apertura de hasta 2,50 m. Su sistema de transmisión premontado y pretensado garantiza un montaje rápido. Movimiento preciso sin ajuste de sincronización.

Máxima difusión de luz natural, máxima comodidad.

● Alu. Silver Mate
Alu. Silver Matte

Unikmatic Air creates spaces with a system attached to a glass wall that guides two bi-parting sliding glass panels with synchronized opening, so that they simultaneously slide to either side. Opening up to 2.50 meters. Its pre-assembled and pre-tightened transmission system guarantees a quick assembly. Precise movement without any synchronization adjustment.

Maximum diffusion of natural light, maximum comfort.

Peso máx./ variable
Max. weight:

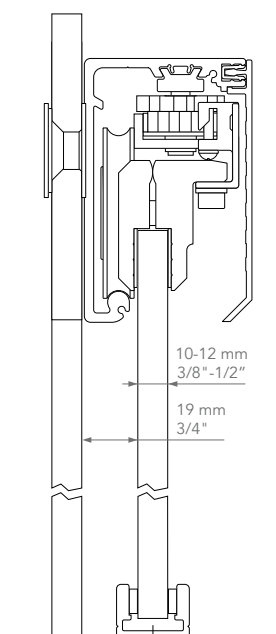
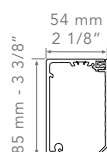



Rollglass Self

Rollglass Self crea espacios mediante un frente acristalado que combina paneles fijos y móviles y dispone de un mecanismo de autocierre "self closing", de velocidad constante y controlada.

Un único perfil aloja tanto los paneles fijos como los correderos: asegura la sencillez de la instalación y minimiza los espacios entre vidrios.

Rollglass Self creates spaces with a glass front that combines fixed and mobile panels and has a self-closing mechanism, which operates at a steady, controlled speed.

Both the fixed and sliding panels are located on a single profile, ensuring a simple installation and minimizing the gap between the glass panels.

- Alu. Silver Mate
- Alu. Silver Matte

Peso máx./ variable
Max. weight:

Freno/ SELF
Brake:

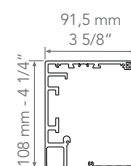

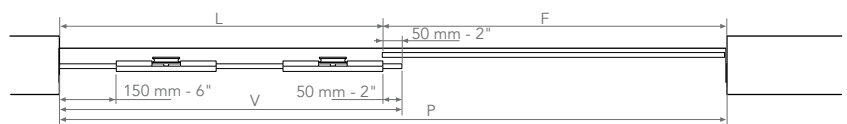
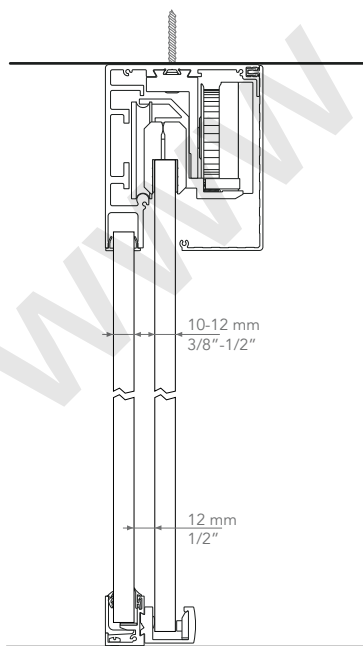

Gama	P	L min	V	F
G1	1.650 mm - 2.000 mm 65" - 78"	800 mm 32"	V=L+50 mm V=L+2"	F=P-L
G2	2.000 mm - 2.500 mm 79" - 98"			
G3	2.500 mm - 3.000 mm 99" - 118"			



KT Glass

KT Glass está diseñado para la instalación de un panel de vidrio mediante un sistema de sujeción tradicional, acorde con un diseño industrial. La versión KT Glass 80 requiere la instalación de un embellecedor para ocultar el mecanismo.

KT Glass is designed for the installation of a glass panel with a traditional fastening system, suitable for an industrial design. The KT Glass 80 version requires the installation of a decorative cover to hide the mechanism.

- Alu. Silver Mate
- Alu. Silver Matte

Peso máx./ 180 kg
Max. weight: 396 lbs

KT GLASS 80

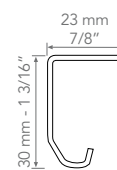

KT GLASS 180
EXPERT

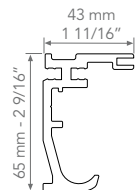



KT GLASS 80

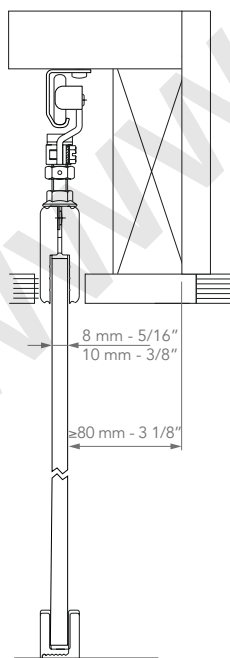

KT GLASS 180 EXPERT

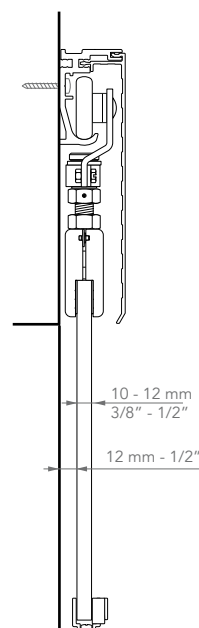

KT GLASS 180 EXPERT

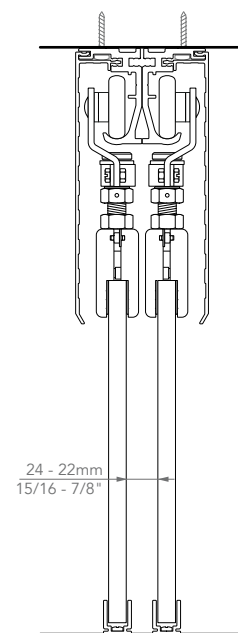



NK Glass

NK Glass está diseñado para la instalación de un panel de vidrio corredero con sistema de sujeción superior tradicional. Requiere la instalación de un embellecedor para ocultar el mecanismo.

NK Glass is designed for the installation of a sliding glass panel with a traditional upper fastening system. It requires the installation of a decorative cover to hide the mechanism.

- Alu. Silver Mate
- Alu. Silver Matte

Peso máx./ 80 kg
Max. weight: 176 lbs

NK GLASS 45

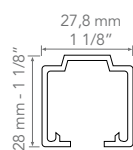

NK GLASS 80

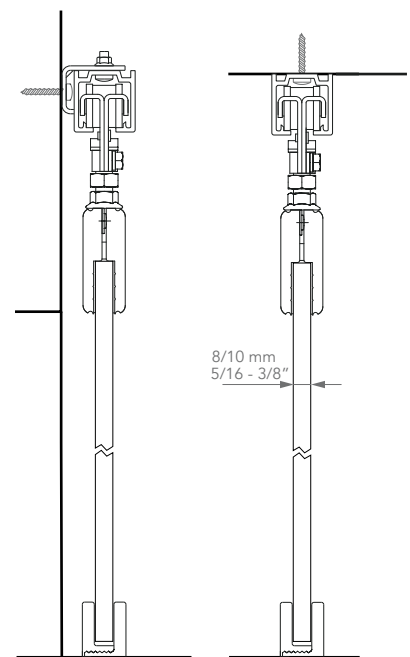
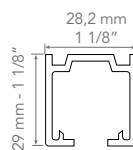



Clos Glass

Clos Glass está diseñado para dar acceso a espacios de almacenamiento mediante dos paneles de vidrio correderos paralelos. Requiere la instalación de un embellecedor para ocultar el mecanismo.

Clos Glass is designed to provide access to storage areas with two bi-passing sliding glass panels. It requires the installation of a decorative cover to hide the mechanism.

● Alu. Silver Mate
Alu. Silver Matte

Peso máx./ 80 kg
Max. weight: 176 lbs

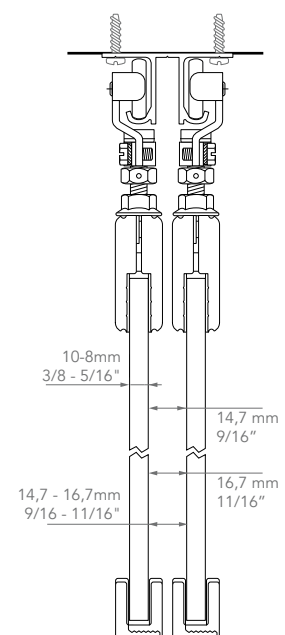
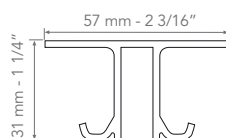



Stockglass

Stockglass permite abrir espacios mediante paneles de vidrio correderos que se apilan perpendicular o paralelamente. Puede disponer de cerradura para cada panel, lo que lo convierte en ideal para zonas comerciales. Configuración con una o dos zonas de aparcamiento.

Aprovechamiento óptimo de la luz de paso.

Stockglass allows you to open up spaces with sliding glass panels that are stacked in either a perpendicular or parallel configuration. Each panel can include its own lock, making this an ideal option for commercial areas. Configuration with one or two areas for storing open doors.

Optimal use of passageway.

● Alu. Silver Mate
Alu. Silver Matte

Peso máx./ 150 kg
Max. weight: 330 lbs

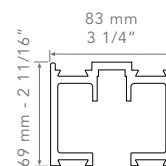

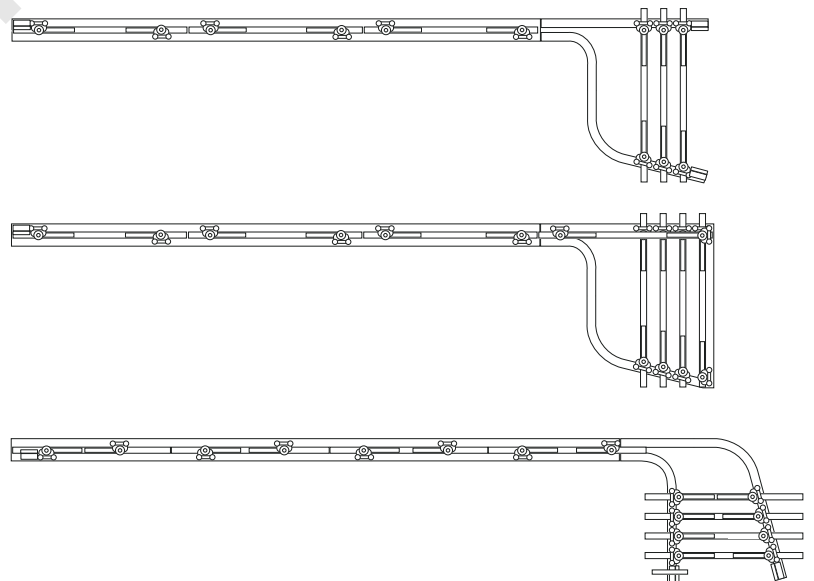
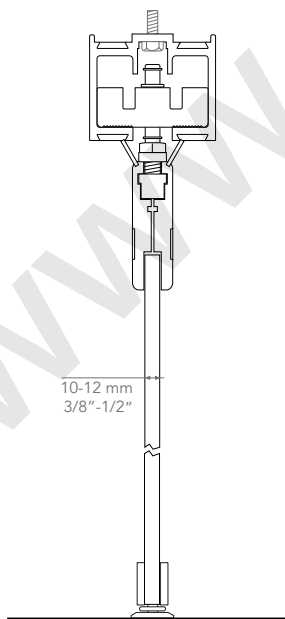









INTERIORISMO **MADERA**

Wood Interior Design

Madera: Calidez y personalización

Wood: Warmth and customization

ESPACIOS EN MOVIMIENTO

¿Son puertas o son tabiques? ¿Son conectores o transformadores de espacios? Son un mundo de posibilidades.

Los paneles móviles de madera conforman estancias flexibles en las que la carpintería interior se convierte en elemento protagonista. La belleza y nobleza del material, así como la variedad de sus acabados y formatos, liberan la creatividad.

La madera de suelo a techo, sin guías en el pavimento, se desliza con suavidad, actuando como mágica transformadora de su entorno. Formatos espectaculares que aumentan y realzan la calidad del espacio.

SPACES IN MOVEMENT

Are they doors or partitions? Do they connect or transform spaces? They are a world of possibilities.

Mobile wood panels create flexible rooms in which the interior woodwork becomes the protagonist. The beauty and elegance of this material, as well as the variety of finishes and sizes available, allow your creativity to flourish.













Floor-to-ceiling wood, without floor tracks, slides along smoothly, transforming its surroundings as if through magic. Spectacular sizes that increase and enhance the quality of the space.





Slid Intra | Interiorismo madera - Wood Interior Design



APLICACIÓN/ APPLICATION	PRODUCTO/ PRODUCT	PÁG./ PAGE	PESO*/ WEIGHT*		FRENO BRAKE			INSTALACIÓN MOUNTING		
			≤100	>100	KBS	KSC	SELF	PARED WALL	TECHO CEILING	EMPOTRABLE RECESSED
PUERTAS CORREDERAS ÚNICAS/ SINGLE SLIDING DOORS		LITE	102	●				●	●	●
		LITE+	102	●		●		●	●	●
		SLID	108	●	●			●	●	●
		NK	112	●				●	●	
		KT	114	●	●			●	●	
PUERTAS PARALELAS/ BI PASSING DOORS		LITE	102	●				●	●	●
		LITE+	102	●		●		●	●	●
PUERTAS PLEGABLES/ FOLDING DOORS		LITE PAR	116	●		●			●	●
		LITE FOLD	118	●		●			●	●
		NK FOLD	122	●				●	●	
		NK PAR	123	●					●	
		KP	124	●				●	●	
PUERTAS APILABLES/ STACKABLE DOORS		STOCKPANEL	126	●	●				●	

* Su peso se calcula en base a la siguiente fórmula: Altura [m] x Ancho [m] x Espesor [mm] x Densidad = Peso [kg]

* The weight is calculated based on the following formula: Height [m] x Width [m] x Thickness [mm] x Density = Weight [kg]



Lite / Lite+

La línea **Lite / Lite+** conecta estancias mediante un panel corredero de madera. Ofrece numerosas configuraciones como puertas paralelas o enfrentadas. Existen 2 tipos de herrajes: Superior (visto) y Retrac (oculto en el panel). Su versión Top permite empotrar el perfil a falso techo.

Tabiques móviles transformadores de espacios interiores.

Sistema de frenado opcional para Lite+ 100: **KSC** - Klein Soft Closing, detención suave controlada.

The **Lite / Lite+** line connects rooms with a sliding wood panel. It offers numerous configurations, such as bi-passing or bi-parting doors. There are two types of fittings: Top (exposed) and Retrac (hidden in the panel). The Top version allows the profile to be recessed in a drop ceiling.

Mobile partitions that transform interior spaces.

Optional braking system for Lite+ 100: **KSC** - Klein Soft Closing, smooth, controlled closing.

- Alu. Silver Mate
Alu. Silver Matte
- Alu. Negro Mate
Alu. Black Matte
- Alu. Bronce Mate
Alu. Bronze Matte

Peso máx./ 100 kg
Max. weight: 220 lbs

Freno/
Brake: KSC

LITE 60

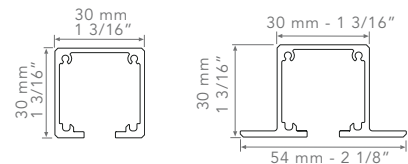

LITE / LITE+ 100

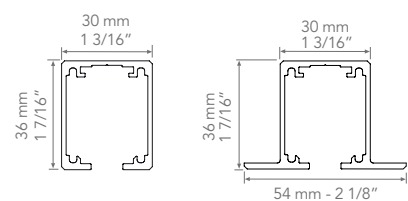



LITE 60

SUPERIOR

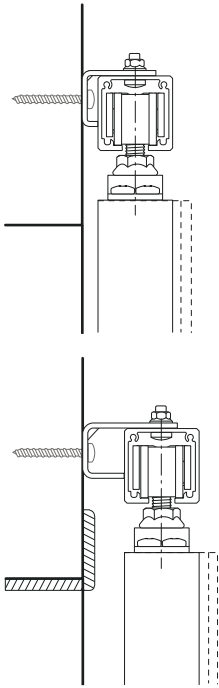

RETRAC

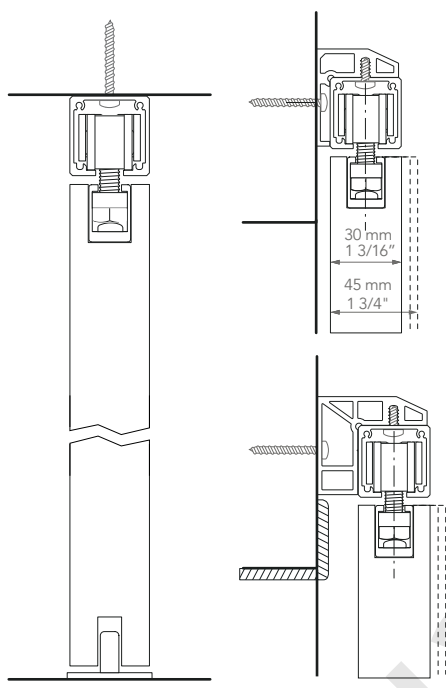

TOP

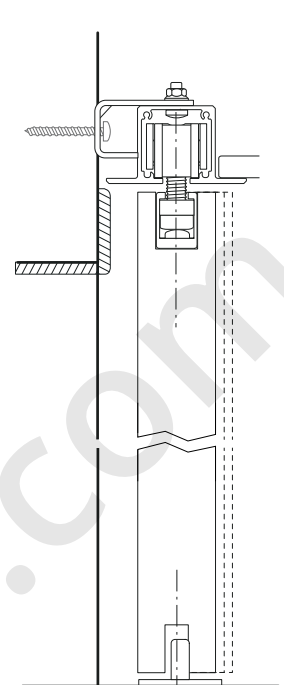

Soporte pared 6 mm /
Wall bracket 6 mm

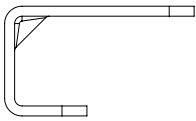

Soporte pared 17 mm /
Wall bracket 17 mm

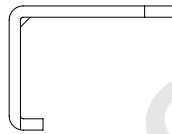

Perfil soporte pared 6 mm /
Wall bracket profile 6 mm

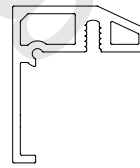

Perfil soporte pared 17 mm /
Wall bracket profile 17 mm

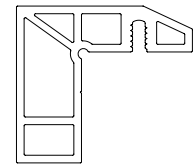

LITE 100 / LITE+ 100

SUPERIOR

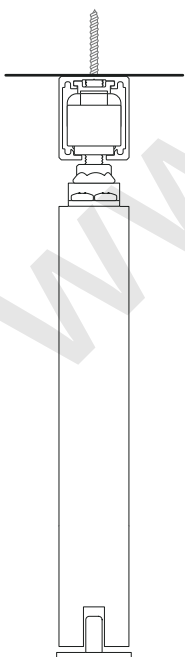

RETRAC

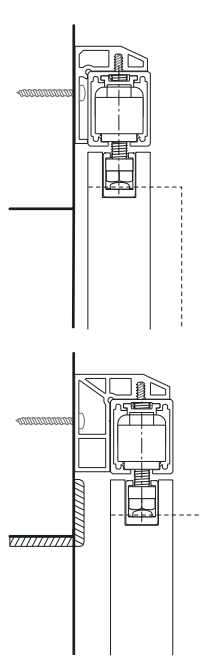

TOP

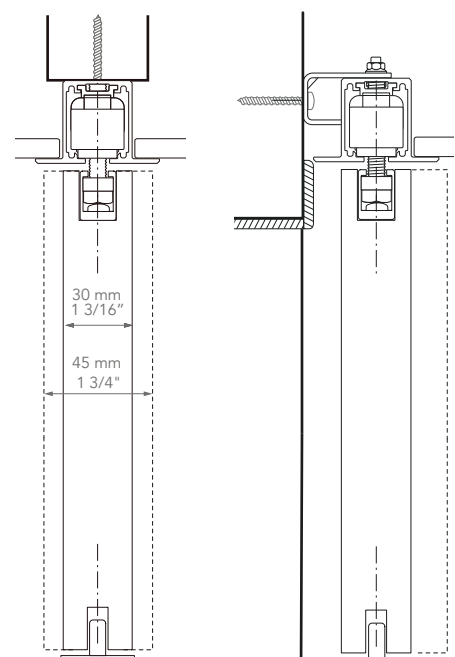

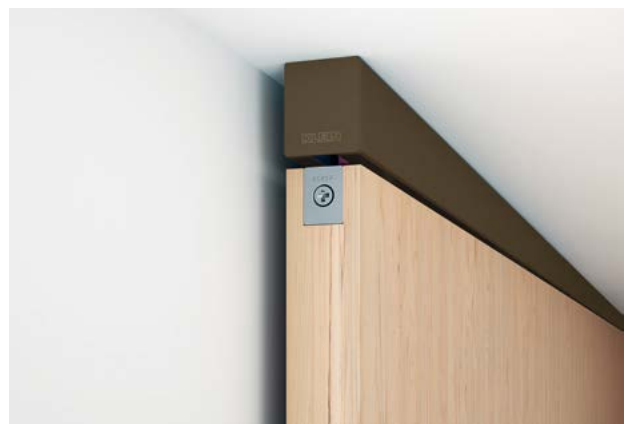





Slid Top | Interiorismo madera - Wood Interior Design



Slid

Slid está diseñado para dividir ambientes mediante paneles de madera o de metal. Un deslizamiento suave y sin esfuerzo.

Ofrece numerosas configuraciones, tales como puertas paralelas, enfrentadas o Corner. Existen 2 tipos de herrajes: Superior (visto) y Retrac (oculto en el panel). El perfil Top permite empotrar el perfil a falso techo. Su versión Intra permite colocar el panel entre paredes.

Tabiques móviles, transformadores de espacios interiores.

Slid is designed to divide spaces with wood or metal panels. Smooth, effortless sliding.

It offers numerous configurations, such as bi-passing, bi-parting doors or corner doors. There are two types of fittings: Top (exposed) and Retrac (hidden in the panel). The Top profile allows the profile to be recessed in the drop ceiling. The Intra version allows the panel to be installed between walls.

Mobile partitions that transform interior spaces.

● Alu. Silver Mate
Alu. Silver Matte

Peso máx./ 150 kg
Max. weight: 330 lbs

SLID 60

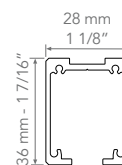

SLID 90

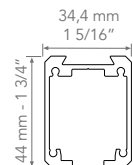

SLID 150

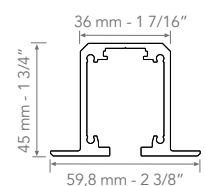
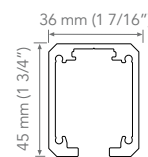



SUPERIOR

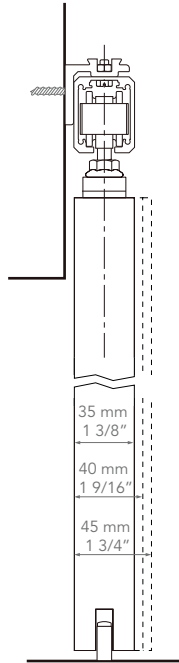

RETRAC

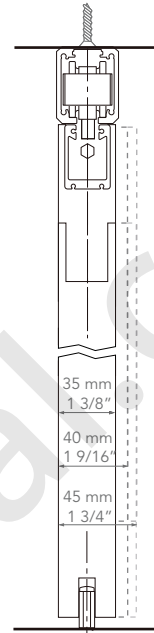

TOP

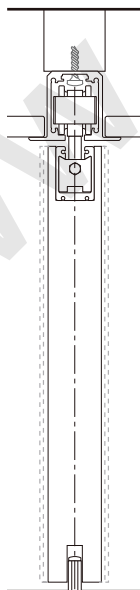

INTRA

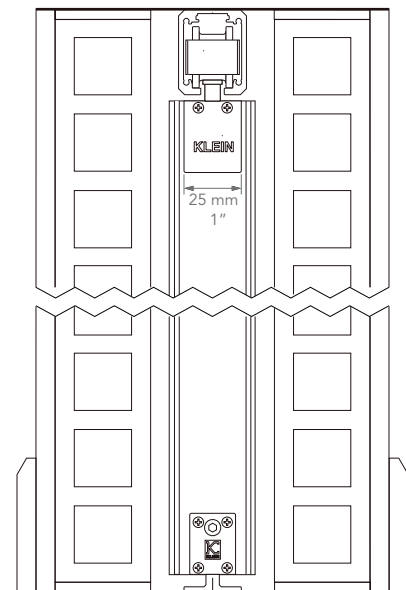

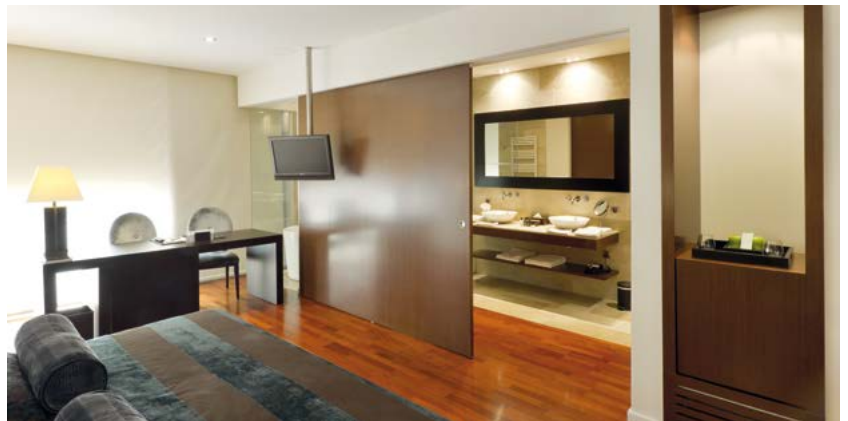
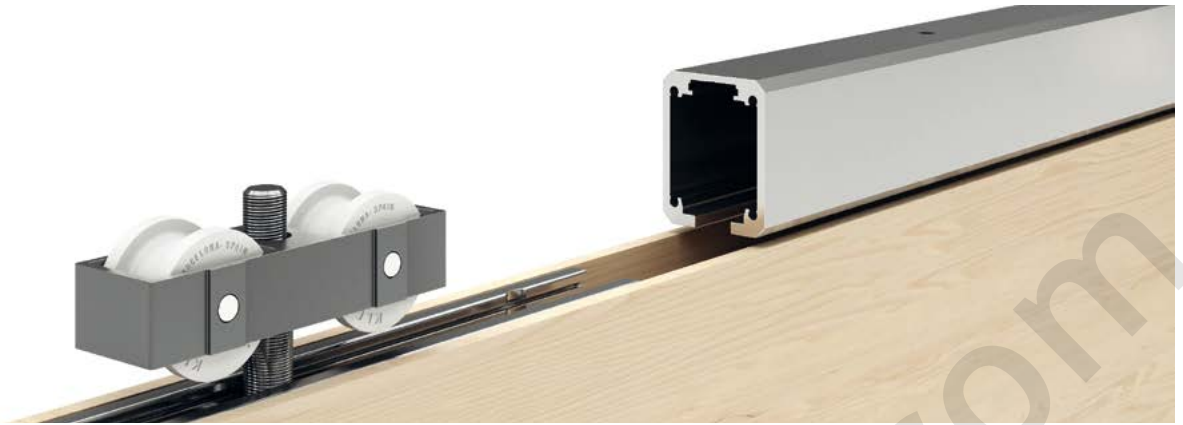



NK

NK está diseñado para guiar un panel corredero de madera o HPL. Ofrece sistema de sujeción horizontal superior o lateral, o sistema de sujeción vertical con herrajes empotrados (Retrac).

Clos NK es su versión para puertas pararelas. En todos sus versiones, requiere la instalación de un embellecedor para ocultar el mecanismo.

NK is designed to guide a wood or HPL sliding panel. It offers a side or horizontal top fastening system. It also offers a vertical fastening system with recessed fittings (Retrac).

Clos NK is the version for bi-passing doors. Regardless of the version, it requires the installation of a decorative cover to hide the mechanism.

● Alu. Natural
Alu. Natural

Peso máx./ 85 kg
Max. weight: 176 lbs

NK 60-85

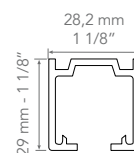

CLOS NK 60

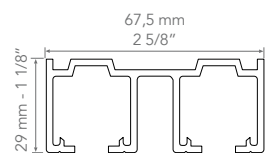

SUPERIOR

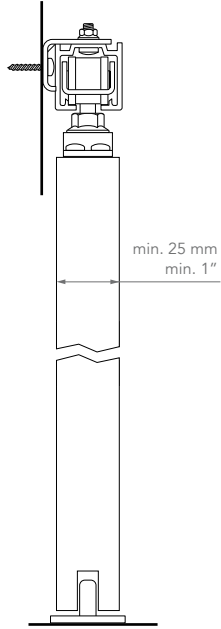

LATERAL

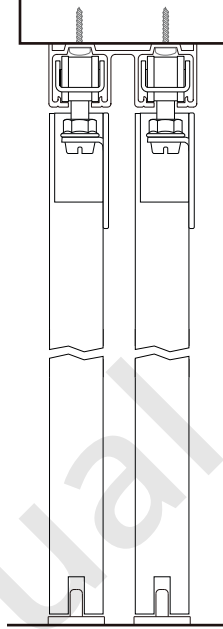

RETRAC

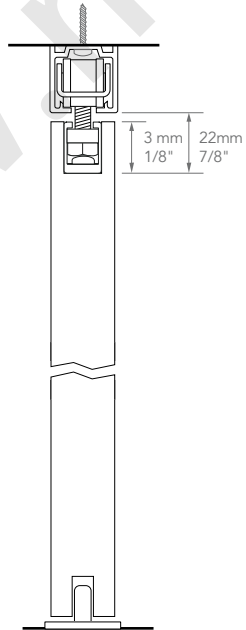

HPL

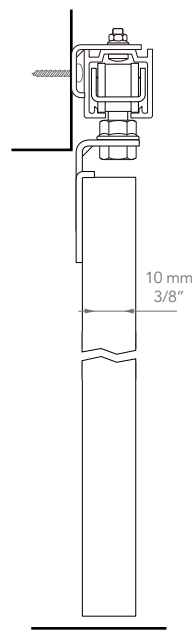



KT

KT está diseñado para conectar espacios mediante un panel corredero de grandes dimensiones, de madera o de metal. Requiere la instalación de un embellecedor para ocultar el mecanismo.

KT is designed to connect spaces with a large-scale sliding panel, made of wood or metal. It requires the installation of a decorative cover to hide the mechanism.

- Alu. Silver Mate
Alu. Silver Matte
- Acero Neocrom
Neocrom steel
- Acero Sendzimir
Sendzimir steel

Peso máx./ 200 kg
Max. weight: 441 lbs

KT 80

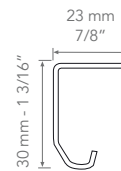

KT 200

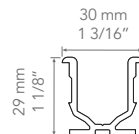
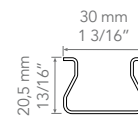
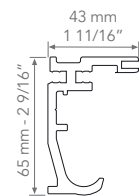



KT 80

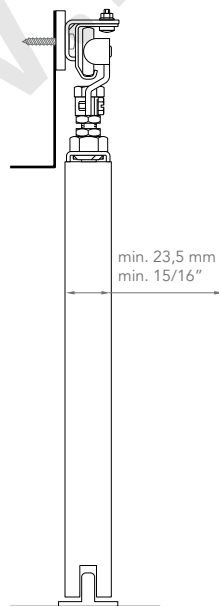

KT 200

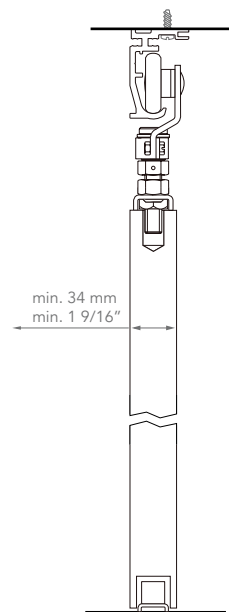



Lite Par

Lite Par abre espacios mediante dos paneles plegables, libres de perfiles en el suelo. Ahorra espacio, garantiza comodidad y un óptimo acceso. Su versión empotrada asegura una máxima integración del perfil en el falso techo.

También disponible en versión enfrentada 2+2.

Lite Par opens up spaces with two folding panels, without any floor profiles. It saves spaces and guarantees comfort and easy access. Its recessed version ensures maximum integration of the profile with the drop ceiling.

Also available as a 2+2 bi-parting version.

- Alu. Silver Mate
- Alu. Silver Matte

Peso máx./ 100 kg
Max. weight: 220 lbs

Freno/
Brake: KSC

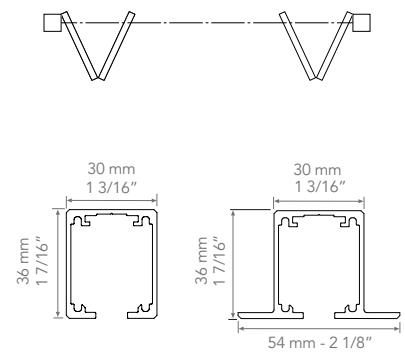

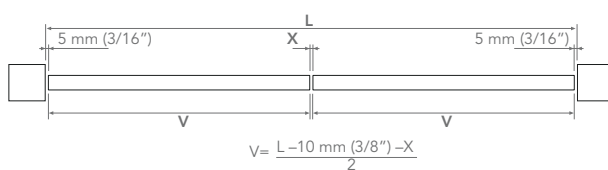
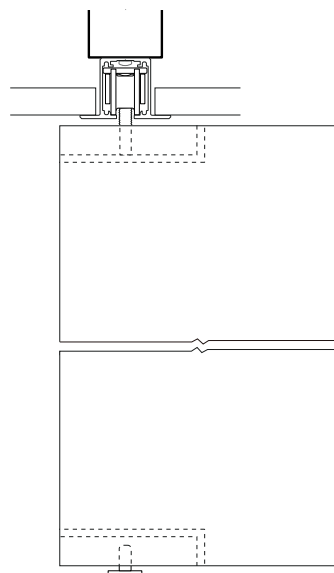
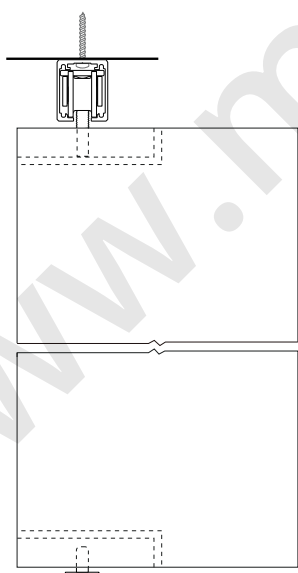



Lite Fold

Lite Fold abre espacios mediante un sistema de 2, 3, 4 o 5 paneles plegables. Ahorra espacio y requiere un aparcamiento reducido. Perfil Top empotrable para instalaciones invisibles.

Compatible con bisagras invisibles estándares.

Lite Fold opens up spaces with a system of 2, 3, 4 or 5 folding panels. It saves spaces and requires very little space for storing open doors. Recessed Top profile for invisible installations.

Compatible with standard invisible hinges.

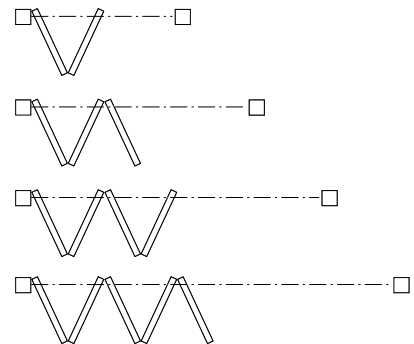

- Alu. Silver Mate
- Alu. Silver Matte

Peso máx./ 100 kg
Max. weight: 220 lbs

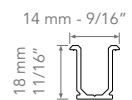
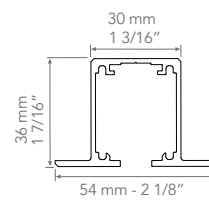
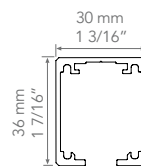

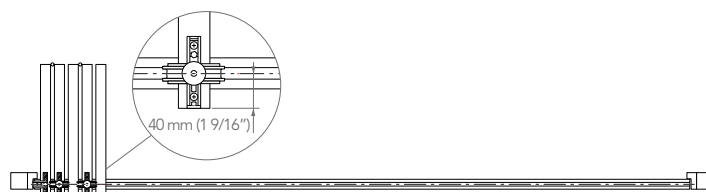
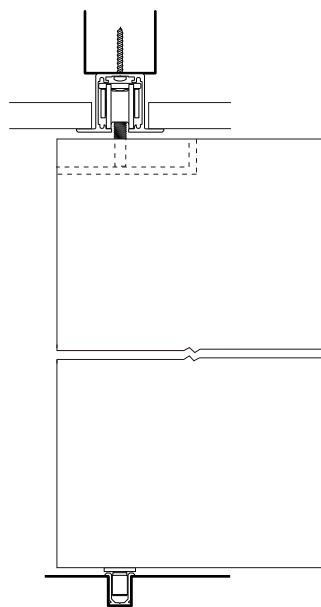
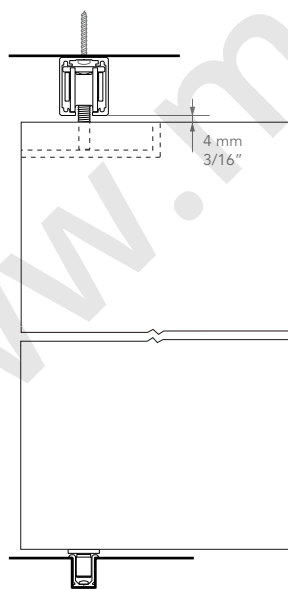

www.mengual.com

Architectural Interior Systems



Slid | Interiorismo Madera - Wood Interior Design



NK Fold

NK Fold es un sistema de apertura de hasta 5 paneles plegables de madera.

Tres opciones de plegado: guiado central, lateral enrasado y lateral solapado.

NK Fold is a system for opening up to 5 folding wood panels.

Three folding options: central guide, flush side guide and overlapping side guide.

- Alu. Silver Mate
Alu. Silver Matte
- Alu. Natural
Alu. Natural

Peso máx./ 40 kg
Max. weight: 88 lbs

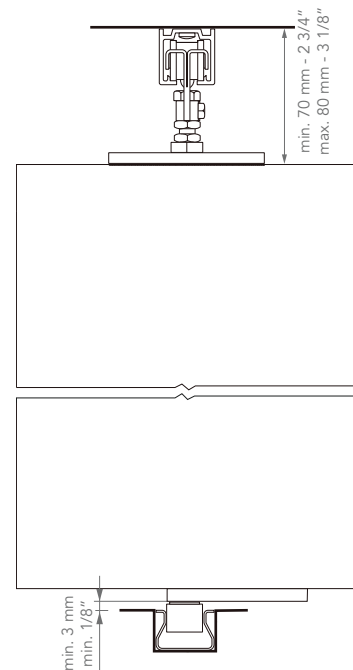
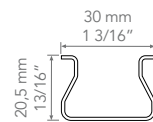
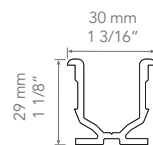
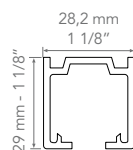



NK Par

NK Par es un sistema para puertas plegables de dos paneles enrasados a pared. Disponible en versión de puertas enfrentadas 2+2.

NK Par is a system for two-panel folding doors that are flush with the wall. It is also available as a 2+2 bi-parting doors version.

- Alu. Silver Mate
Alu. Silver Matte
- Alu. Natural
Alu. Natural

Peso máx./ 40 kg
Max. weight: 88 lbs

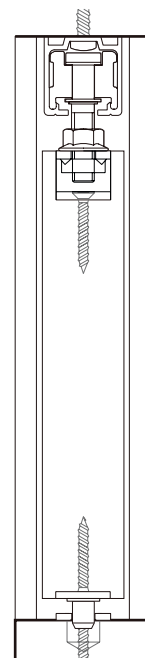
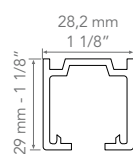



KP

KP es un sistema de apertura de hasta 5 paneles plegables de madera o de metal.

Tres opciones de plegado: guiado central, guiado lateral enrasado superpuesto, guiado lateral con hojas solapadas.

KP is a system for opening up to 5 folding wood or metal panels.

Three folding options: central guide, superimposed flush side guide and overlapping panel side guide.

● Alu. Silver Mariner
Alu. Silver Mariner

Peso máx./ 100 kg
Max. weight: 220 lbs

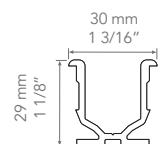
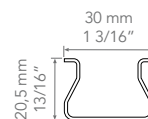
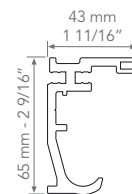



KP 100 C

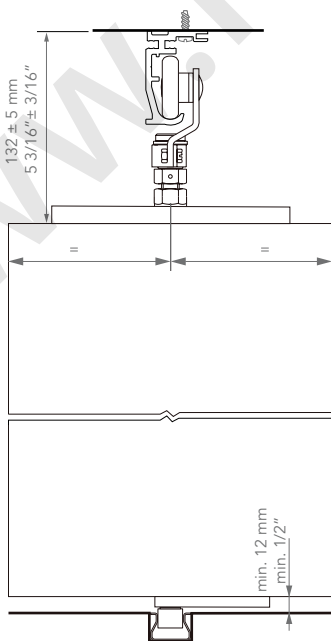

KP 100 S

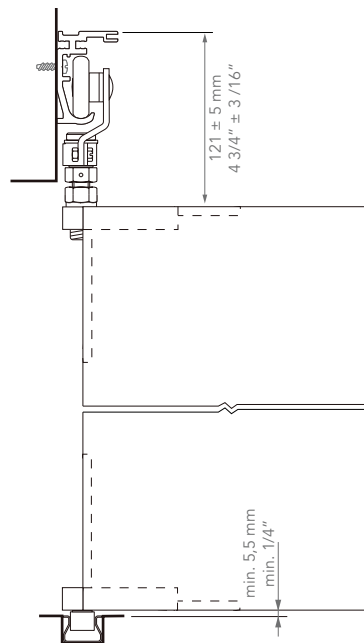



Stockpanel

Stockpanel está diseñado para abrir espacios mediante paneles de madera correderos, que se apilan perpendicular o paralelamente. Es ideal para dividir salas de restaurantes o salas de conferencias. Configuración con una o dos zonas de aparcamiento.

Aprovechamiento óptimo de la luz de paso.

Stockpanel is designed to open up spaces with sliding wood panels that are stacked in either a perpendicular or parallel configuration. It is ideal for dividing restaurant dining rooms or conference rooms. Configuration with one or two areas for storing open doors.

Optimal use of passageway.

● Alu. Silver Mate
Alu. Silver Matte

Peso máx./ 150 kg
Max. weight: 330 lbs

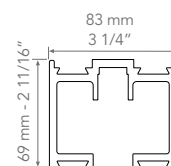

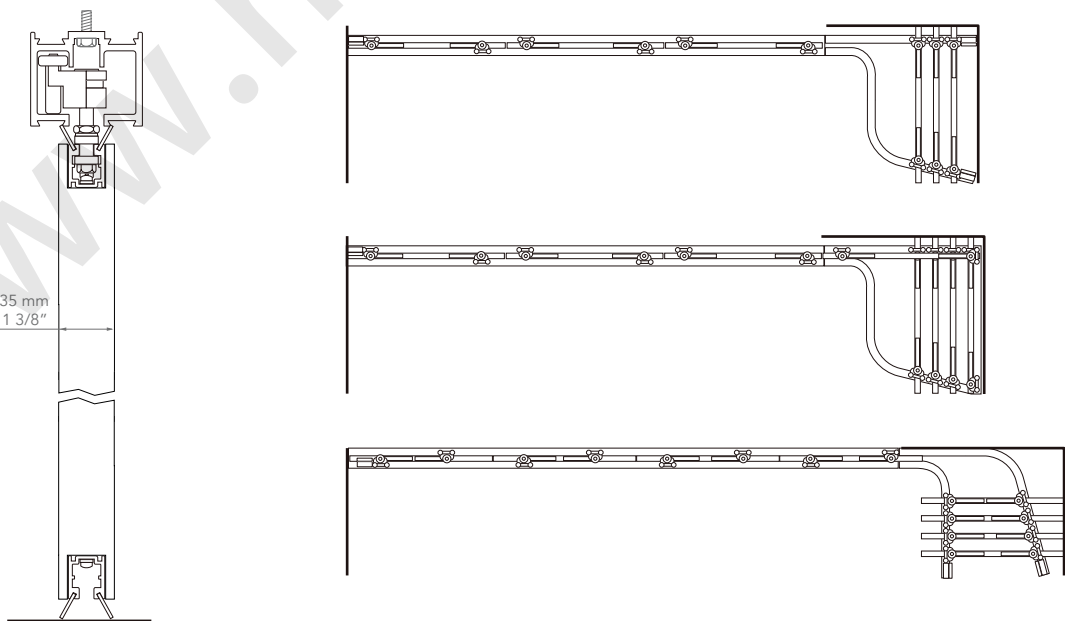











DISEÑO
INDUSTRIAL

Industrial Design



K | Diseño industrial - Industrial Design

APLICACIÓN/ APPLICATION	PRODUCTO/ PRODUCT	PÁG./ PAGE	PESO*/ WEIGHT*		FRENO BRAKE			INSTALACIÓN MOUNTING		
			≤100	>100	KBS	KSC	SELF	PARED WALL	TECHO CEILING	EMPOTRABLE RECESSED
PUERTAS CORREDERAS ÚNICA/ SINGLE SLIDING DOORS		K	134	•	•			•	•	
PUERTAS PLEGABLES/ FOLDING DOORS		PL	136	•	•			•	•	
PUERTAS ARTICULADAS/ ARTICULATED DOORS		AR	138	•	•			•	•	

* Su peso se calcula en base a la siguiente fórmula: Altura [m] x Ancho [m] x Espesor [mm] x Densidad = Peso [kg]

* The weight is calculated based on the following formula: Height [m] x Width [m] x Thickness [mm] x Density = Weight [kg]

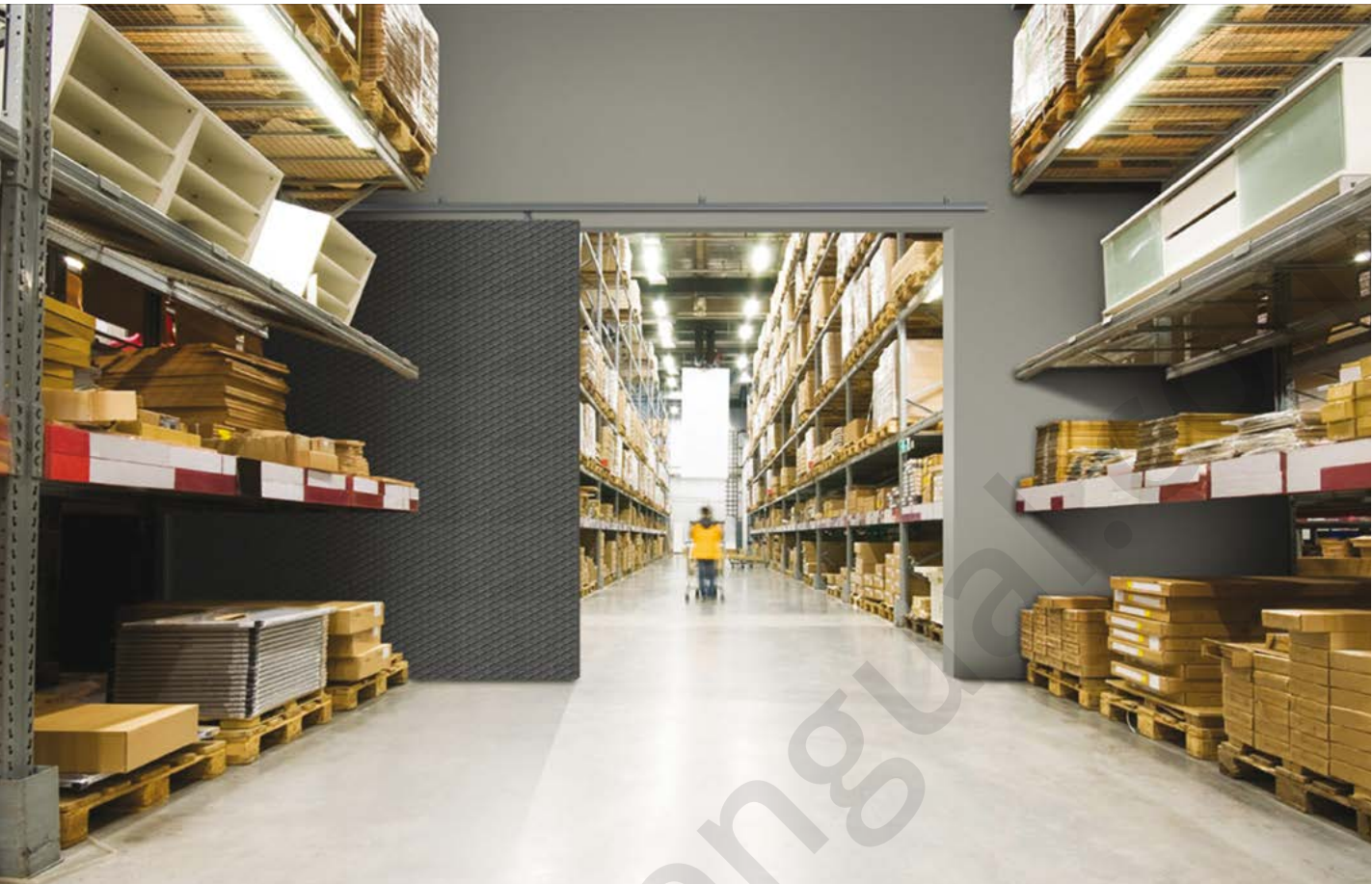

K

K es el sistema ideal para espacios industriales. Está diseñado para dividir ambientes mediante un único panel de grandes dimensiones, de madera o de metal.

K is the ideal system for industrial spaces. It is designed to divide spaces with a single large-scale panel, made of wood or metal.

- Acero Neocrom
Neocrom Steel
- Acero Sendzimir
Sendzimir steel

Peso máx./ 500 kg
Max. weight: 1102 lbs

K 40/75

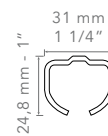

K 150/300

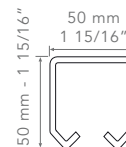

K 500

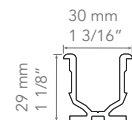
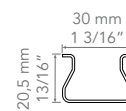
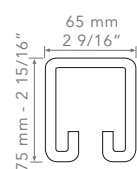



K 40/75

K 150/300

K 500

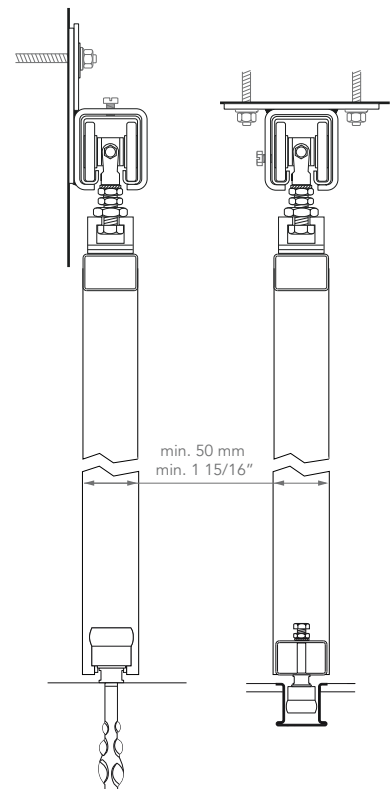
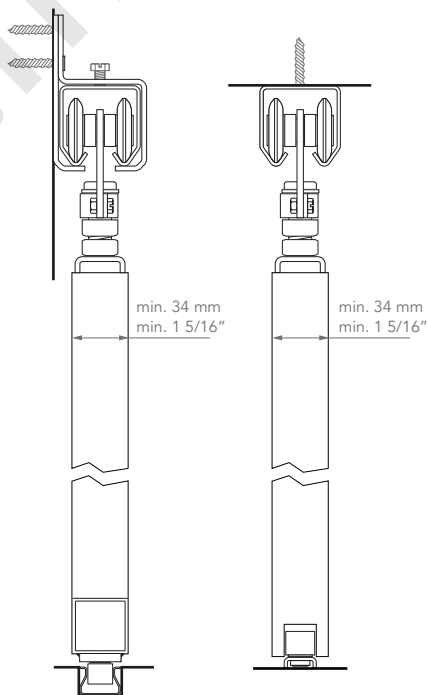
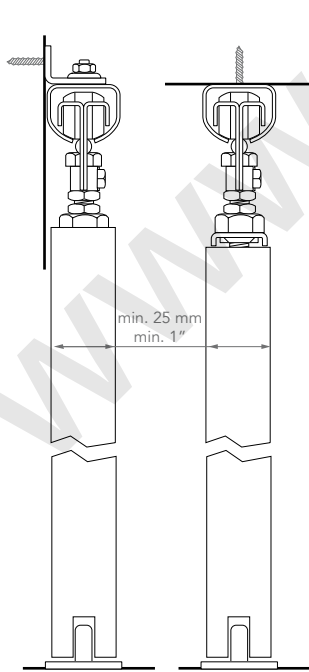



PL

PL es un sistema de apertura de hasta 5 paneles plegables de madera o de metal.

Tres opciones de plegado: guiado central, lateral enrasado y lateral solapado.

PL is a system for opening up to 5 folding wood or metal panels.

Three folding options: central guide, flush side guide and overlapping side guide.

- Acero Neocrom
Neocrom Steel
- Acero Sendzimir
Sendzimir steel

Peso máx./ 150 kg
Max. weight: 330 lbs

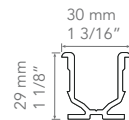
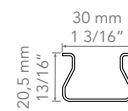
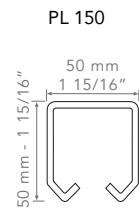
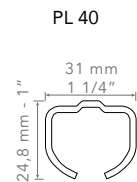

PL 40 C

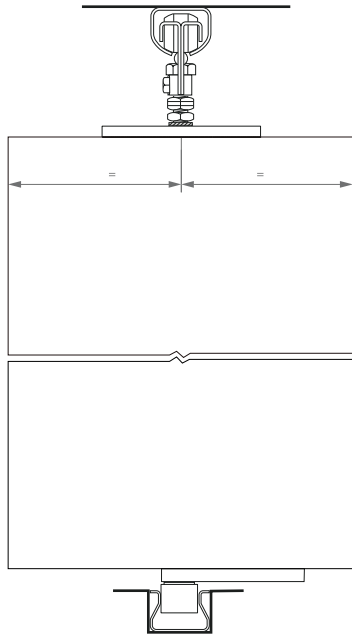

PL 40 S

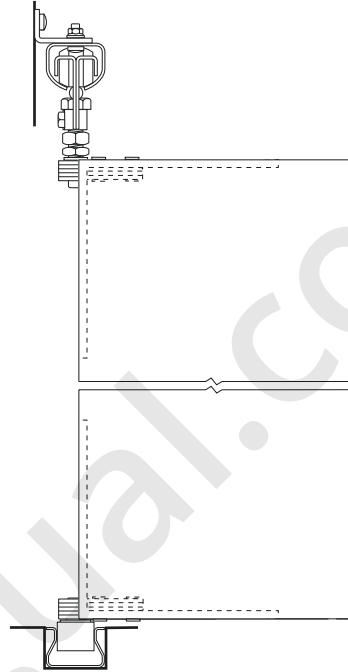

PL 150 C

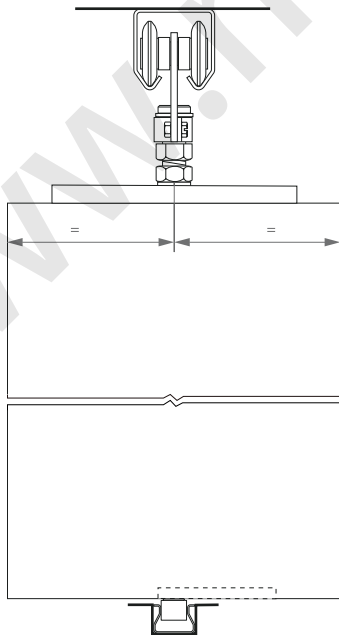

PL 150 E

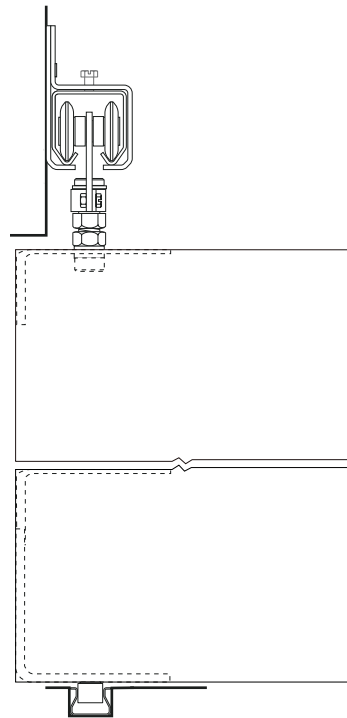



AR

AR está diseñado para abrir espacios mediante un sistema de paneles articulados de madera o de metal. Admite un máximo de 5 hojas por sistema.

AR is designed to open up spaces with a system of hinged wood or metal panels. It supports up to 5 panels per system.

Acero Neocrom
Neocrom Steel

Peso máx./ 125 kg
Max. weight: 276 lbs

AR 35

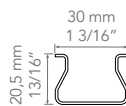
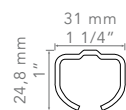

AR 125

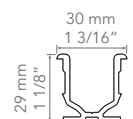
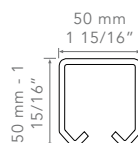

AR 35

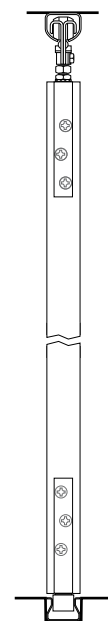

AR 125

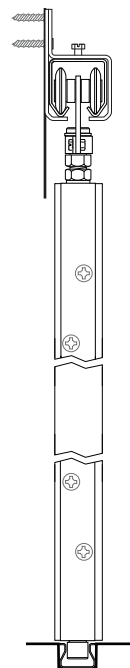

www.mengual.com

Architectural Interior Systems





www.mengual.com







Roll I Muebles y armarios - Furniture and wardrobes

MUEBLES Y **ARMARIOS**

Furniture and wardrobes



Roll | | Muebles y armarios - Furniture and wardrobes

APLICACIÓN/ APPLICATION	PRODUCTO/ PRODUCT	PÁG./ PAGE	PESO*/ WEIGHT*		FRENO BRAKE			INSTALACIÓN MOUNTING		
			≤100	>100	KBS	KSC	SELF	PARED WALL	TECHO CEILING	EMPOTRABLE RECESSED
PUERTAS PARALELAS/ BI PASSING DOORS		K	146	●					●	
		ROLL	148	●					●	
		ROLL TOP	150	●				●		
PUERTAS PLEGABLES/ FOLDING DOORS		NK PAR	152	●					●	

* Su peso se calcula en base a la siguiente fórmula: Altura [m] x Ancho [m] x Espesor [mm] x Densidad = Peso [kg]

* The weight is calculated based on the following formula: Height [m] x Width [m] x Thickness [mm] x Density = Weight [kg]



K

K está diseñado para la apertura de muebles y armarios mediante uno o varios paneles correderos paralelos de madera, con el fin de conseguir varios accesos dentro de la misma aplicación.

K is designed for opening furniture and wardrobes with one or several bi-passing sliding wood panels, thus allowing for several access points in a single application.

- Alu. Natural
Alu. Natural
- Acero Neocrom
Neocrom Steel
- Acero Sendzimir
Sendzimir steel

Peso máx./ 30 kg
Max. weight: 66 lbs

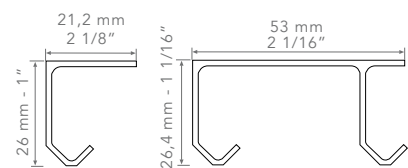

K 20/30

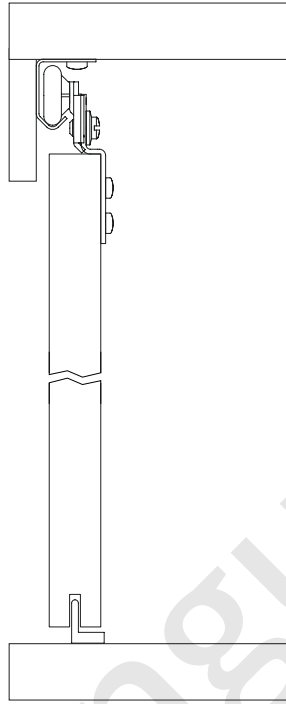

K 20/30
PERFIL DOBLE / DOUBLE TRACK

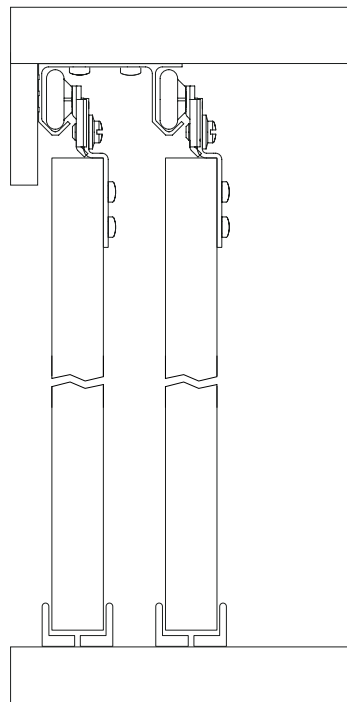
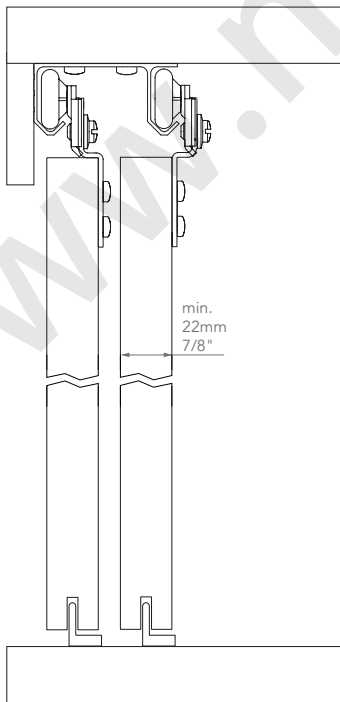



Roll

Roll está diseñado para la apertura de muebles y armarios mediante dos paneles paralelos de madera. Garantiza un mínimo espacio entre puerta y marco.

Roll is designed for opening furniture and wardrobes with two bi-passing wood panels. It guarantees a minimal gap between the door and frame.

- Alu. Natural
Alu. Natural
- Alu. Silver
Alu. Silver
- Alu. Negro
Alu. Black
- Alu. Brass
Alu. Brass

- PVC Marron
Brown PVC
- PVC Blanco
White PVC
- PVC Negro
Black PVC

Peso máx./ 52 kg
Max. weight: 115 lbs

ROLL 25

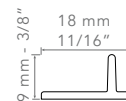

ROLL 42

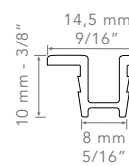

ROLL 52

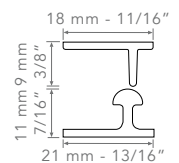



ROLL 42

ROLL 45

ROLL 52

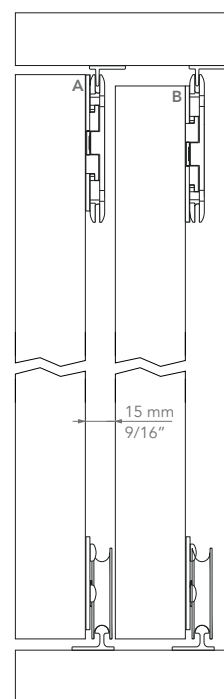
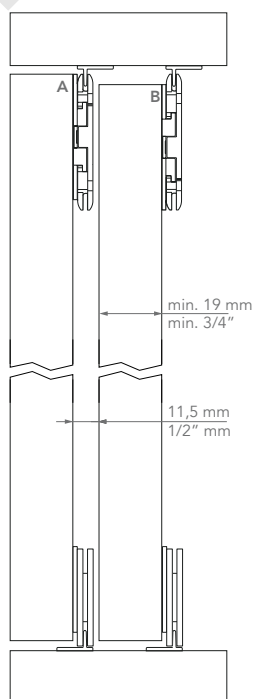
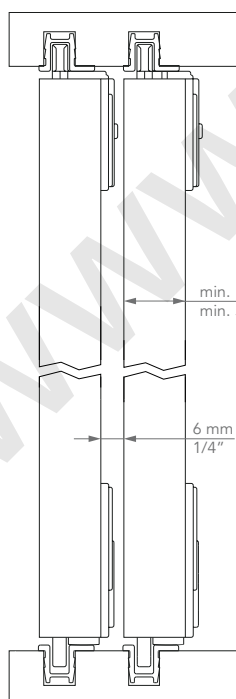



Roll Top

Roll Top está diseñado para la apertura de armarios mediante dos o tres paneles de madera que se mueven paralelamente. El perfil superpuesto al canto del armario permite que las puertas se deslicen las unas al lado de las otras sin necesidad de ningún tipo de mecanización previa del marco.

Roll Top is designed for opening wardrobes with two or three wood panels that move parallel to one another. The profile, superimposed over the edge of the wardrobe, allows the doors to slide along next to each other without ever having to drill the frame.

- Alu. Silver Mate
- Alu. Silver Matte

Peso máx./ 30 kg
Max. weight: 66 lbs

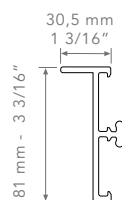

ROLL TOP 30 INT

ROLL TOP 30 EXT

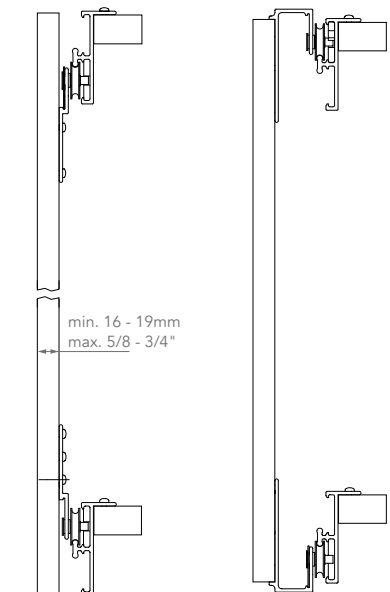



NK Par

NK Par es un sistema para armarios, de dos paneles plegables. Existe en versión para puertas enrasadas o puertas sobrepuestas.

NK Par is a system for wardrobes, with two folding panels. There is a version for flush doors and another for superimposed doors.

- Alu. Natural
Alu. Natural
- PVC Marron
Brown PVC
- PVC Blanco
White PVC
- PVC Negro
Black PVC

Peso máx./ 25 kg
Max. weight: 55 lbs

NK PAR 15/25

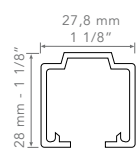

NK PAR 15

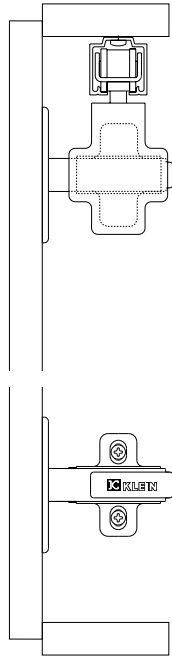

NK PAR 25

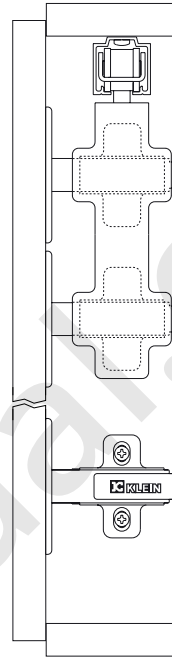

www.menggunakan.com