

CATÁLOGO PRODUCTOS 2016-2017

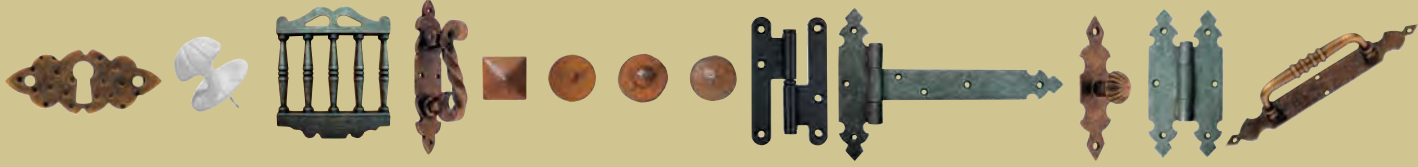

Emilio Tortajada, S.L.

Cerrajería Mecánica - Herraje Castellano

Fabricación Española, desde 1886



Emilio Tortajada, S.L.

Cerrajería Mecánica - Herraje Castellano y Forja

Desde 1886

100% HECHO EN ESPAÑA



CONDICIONES GENERALES DE VENTA

MODO DE EFECTUAR UN PEDIDO O CONSULTA:

Vía correo electrónico a: comercial@emiliotortajadasl.com / DireccionComercial@emiliotortajadasl.com

A través del comercial de la zona; Listado de **equipo comercial** en la **página nº 83**.

Telefónico al número: 96.140.02.30

Vía Fax al número: 96.141.73.43

MODO DE EFECTUAR UN PEDIDO O CONSULTA DE PRODUCTOS ESPECIALES:

Cualquier necesidad de nuestros clientes, ya sea referente a:

- modificación de medidas de un producto actual en nuestro catálogo,
- necesidad de un diferente color de acabado no reseñado en la lista de acabados disponibles dentro y fuera de stock,
- diseño y fabricación de un nuevo producto a medida,

serán atendidos de forma personalizada en nuestro teléfono de la empresa o vía mail en las direcciones: comercial@emiliotortajadasl.com / DireccionComercial@emiliotortajadasl.com, adjuntando un dibujo o croquis de la pieza a presupuestar.

DISPONIBILIDAD DE PRODUCTOS Y PLAZOS DE ENTREGA:

Todas las familias de productos de éste catálogo se distribuyen en dos diferentes categorías definidas por tipo de acabado; acabados en stock, acabados bajo pedido.

ACABADOS EN STOCK:

En el caso de las familias marcadas con acabados "en Stock" el plazo de salida del material será inmediato, entendiéndose éste entre 1 y 7 días desde la confirmación del pedido.

ACABADOS BAJO PEDIDO:

En el caso de las familias marcadas con acabados "Bajo Pedido" el plazo de salida del material será no mayor de 15 días desde la confirmación del pedido. Si hubiera un retraso programado de baños, se notificará al cliente, los días de demora en el servicio.

Para los pedidos que contengan referencias de los dos grupos, en el caso que lo solicite se notificará al cliente el plazo previsto de entrega de la salida prevista del pedido completo, en otro caso, el tiempo total de la entrega se registrará por el acabado que más días tarde en ser terminado.



EMPRESA



ACABADOS EN STOCK

ACABADOS BAJO PEDIDO



1- NEGRO CASTELLANO



A- ANTICUARIO

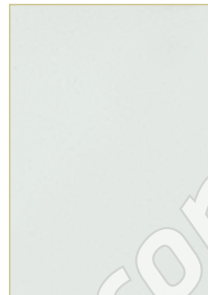

7-BLANCO

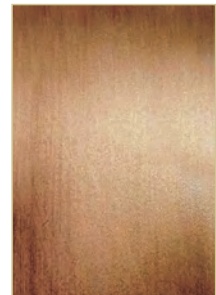

L- BRONCE INGLÉS



P- PLATA VIEJA



9- RUSTIK



H- LATÓN MATE



N- NIQUEL MATE



2- LATÓN BRILLO



0- PULIDO

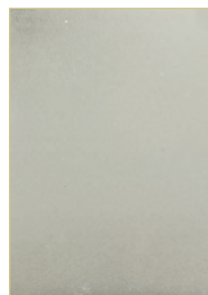

6- NIQUEL BRILLO



C- COBRE BRILLO



4- ZINCADO

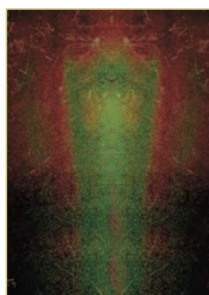

3- BICROMATADO



8- ÓXIDO NATURAL



M- FRAGUA



www.mengual.com

INDICE DE FAMILIAS

Asas	006
Bisagras	018
Cerrojos	080
Cierres	084
Clavos	048
Condenas y Muletillas	078
Cremonas	098
Escuadras	102
Escudos y Bocallaves	054
Eses Retenidas	092
Fallebas y Tercios de Falleba	094
Golfos	036
Llamadores	050
Manivelas Automáticas	058
Manivelas Manuales	072
Manivelas Grisán	070
Medias Fallebas	098
Mirillas	052
Números, Letras, Carteles	106
Pasadores	088
Perchas	110
Pernios	046
Pomos	074
Soporte Pasamanos	100
Tiradores para Mueble	014
Tornillos	108



ASAS

HERRAJE CASTELLANO



ASA FIJA PUERTA

- * 112, 116, 138
- * Farolillo 390
- * 501
- 502
- 503
- * Italy 504
- 129

ASAS FIJA PORTÓN

- 128
- 128B

007
008
011
009
010
011
010

010
010

ASA TIRADOR FIJA CAJÓN

- 114, 115

ASA TIRADOR MOVIBLES CAJÓN

- 113
- 117
- * 127

ASA TIRADOR BAÚL

- * 110, 1110

012

013
013
013

013

Para más modelos, visita nuestro catálogo de Fragua y Grannoble; www.emiliotortajadasl.com

ACABADOS EN STOCK: 1- NEGRO CASTELLANO / A- ANTICUARIO / P- PLATA VIEJA / 9- RUSTIK / 0- PULIDO

ACABADOS BAJO PEDIDO: 7- BLANCO / 2- LATÓN BRILLO / H- LATÓN MATE / 6- NIQUEL BRILLO / N- NIQUEL MATE / L- BRONCE INGLÉS / C- COBRE BRILLO / 3- BICROMATADO / 4- ZINCADO / * 8- ÓXIDO NATURAL / * M- FRAGUA



112MB para bocallave
También sin bocallave / 112M Desplazada



112L, 116L

112M, 116M

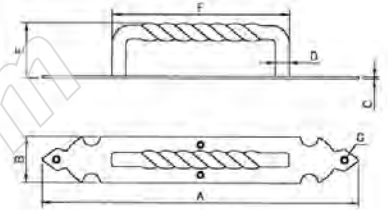

Ref.	A	B	C	D	E	F	G
112-M	275	40	2	12	52	150	Ø4,5
112-L	275	40	2	12	52	150	Ø4,5
116-M	210	32	2	10	45	125	Ø4,5
116-L	210	32	2	10	45	125	Ø4,5

Medidas en mm.



112P, 116P



112R, 116R
Con tirafondos

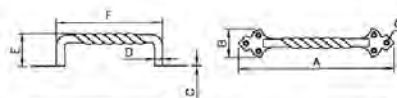

Ref.	A	B	C	D	E	F	G
112-P	218	40	2,5	12	55	150	Ø5
116-P	180	35	2,5	10	48	125	Ø5

Medidas en mm.



138
Largo (F): 210 mm
∅: 14 mm
Con tirafondos





390/95



390/96



390/104
390/104G



390/105
390/105G



390/109
390/109-G



390/94

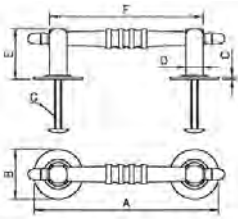

Ref.	A	B	C	D	E	F	G
502	188	∅50	2	∅18	50	156	M6x70

Medidas en mm.

Montaje con tirafondos / Antirrobo



502

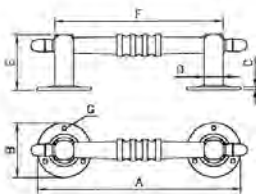

Ref.	A	B	C	D	E	F	G
502/95	188	∅50	2	∅18	50	156	∅4

Medidas en mm.



502/95

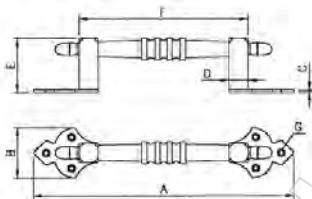

Ref.	A	B	C	D	E	F	G
502/96	236	46	2,5	∅18	50	156	∅5

Medidas en mm.



502/96

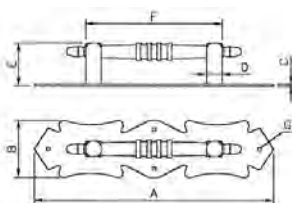

Ref.	A	B	C	D	E	F	G
502/94	272	65	2	18	50	156	∅4,5

Medidas en mm.



502/94



503



503/95



503/94

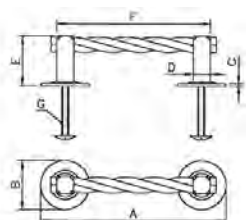

Ref.	A	B	C	D	E	F	G
503	188	∅50	2	∅18	50	156	M6x70

Medidas en mm

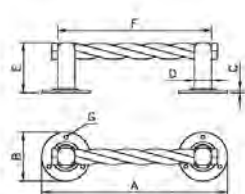

Ref.	A	B	C	D	E	F	G
503/95	188	∅50	2	∅18	50	156	∅4

Medidas en mm

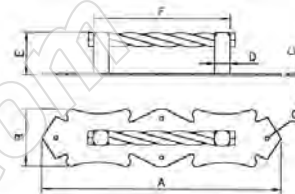

Ref.	A	B	C	D	E	F	G
503/94	272	65	2	18	50	156	∅4,5

Medidas en mm

Montaje con tirafondos / Antirrobo

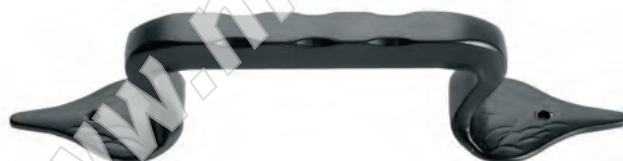

129



128

Montaje con tirafondos / Antirrobo / Cuadrado 20 mm macizo



501/104
501/104G



501/105
501/105G



501/109G

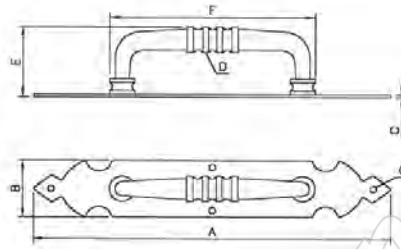

Ref.	A	B	C	D	E	F	G
501/104	275	40	2	∅20	54	160	∅4,5
501/105	275	40	2	∅20	54	160	∅4,5
501/104-G	285	45	2	∅20	54	160	∅4,5
501/105-G	265	45	2	∅20	54	160	∅4,5

Medidas en mm.

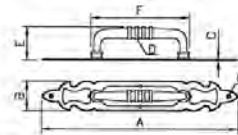

Ref.	A	B	C	D	E	F	G
501/109-G	325	50	2	∅20	54	160	∅5

Medidas en mm.

Italy 504



504/131 Escudo martilleado

504/132 Escudo liso

Se puede montar con cualquier escudo de Asas

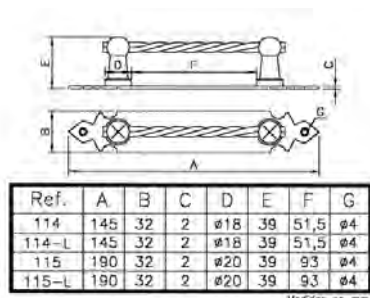

114, 115



114L, 115L



114L Anticuario



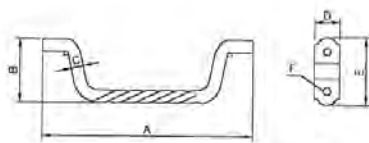

Ref.	A	B	C	D	E	F
113	124	39	ø9	12	32	ø4
113-P	100	30	ø8	12	32	ø4

Medidas en mm.



113,113P



113 Anticuario



117, 117P



117L, 117LP



127



110

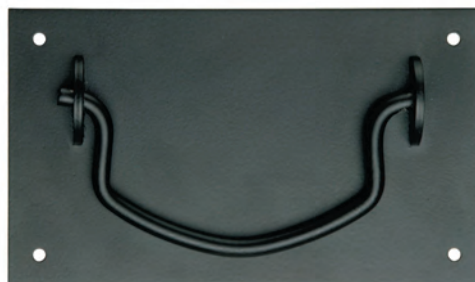

1110

TIRADORES

HERRAJE CASTELLANO



TIRADORES ANILLA Y PÉNDULO

28V, 28H	015
31V, 31H	015
75, 75P, 95V	016
80, 80P, 95H	016
85, 85P	016
500P, 500A	016

TIRADORES POMO

* 28, 30	017
* 31, 32	017
* 33, 67	017

TIRADORES POMO CON ROSCA

* 498, 499, 500	017
-----------------	-----

Para más modelos, visita nuestro catálogo de Fragua y Grannoble; www.emiliotortajadasl.com

ACABADOS EN STOCK: 1- NEGRO CASTELLANO / A- ANTICUARIO / P- PLATA VIEJA / 9- RUSTIK / 0- PULIDO

ACABADOS BAJO PEDIDO: 7- BLANCO / 2- LATÓN BRILLO / H- LATÓN MATE / 6- NIQUEL BRILLO / N- NIQUEL MATE / L- BRONCE INGLÉS / C- COBRE BRILLO / 3- BICROMATADO / 4- ZINCADO / * 8- ÓXIDO NATURAL / * M- FRAGUA

Ref.	A	B	C	D
28-H	30	90	Ø 4	1,5

medidas en mm.

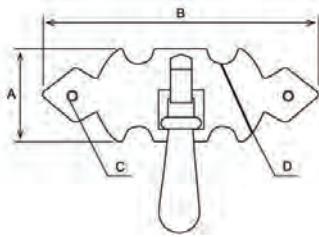

28V



28H

Ref.	A	B	C	D
28-HA	30	90	Ø 4	1,5

medidas en mm.

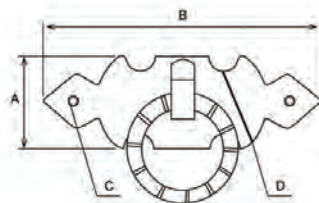

28VA



28HA



31V



31H



31VA



31HA



75
75P
95V



75A
75PA
95VA

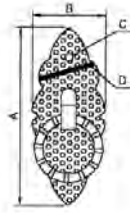

Ref.	A	B	C	D
75-A	90	38	ø4	1,5
75-PA	80	30	ø4	1,5
95-VA	65	27	ø4	1,5

Medidas en mm.

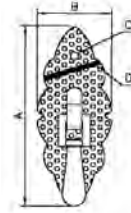

Ref.	A	B	C	D
75	90	38	ø4	1,5
75-P	80	30	ø4	1,5
95-V	65	27	ø4	1,5

Medidas en mm.



80
80P
95H



80A
80PA
95HA

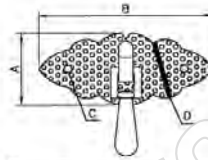

Ref.	A	B	C	D
80	38	90	ø4	1,5
80-P	30	80	ø4	1,5
95-H	27	65	ø4	1,5

Medidas en mm.

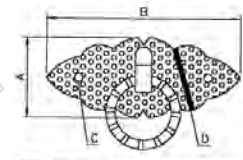

Ref.	A	B	C	D
80-A	38	90	ø4	1,5
80-PA	30	80	ø4	1,5
95-HA	27	65	ø4	1,5

Medidas en mm.



500A

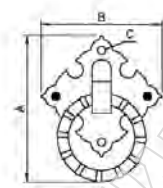

Ref.	A	B	C
500-A	64	42	ø4

Medidas en mm.



500P

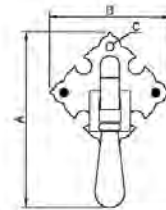

Ref.	A	B	C
500-P	54	42	ø4

Medidas en mm.



85, 85P

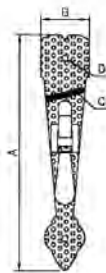

Ref.	A	B	C	D
85	155	30	1,5	ø4
85-P	130	28	1,5	ø4

Medidas en mm.



85A, 85PA

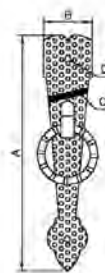

Ref.	A	B	C	D
85-A	155	30	1,5	ø4
85-PA	130	28	1,5	ø4

Medidas en mm.

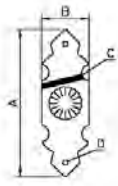

Ref.	A	B	C	D
28	90	30	1,5	ø3

Medidas en mm.



28

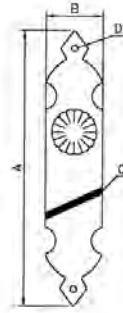

Ref.	A	B	C	D
30	145	30	1,5	ø3

Medidas en mm.



30
con Bocallave 30B



33
33B con Bocallave



67



31



Ref.	A	B	C	D
31	90	30	1,5	ø3

Medidas en mm.



32

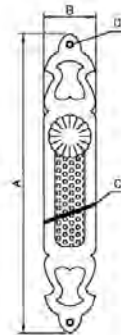

Ref.	A	B	C	D
32	145	30	1,5	ø3

Medidas en mm.



499



498



500

Ref.	A	B	C	D	E
500	19	24	4	30	30
	24	26	4	30	30
	33	32	4	30	30

Medidas en mm.

BISAGRAS

HERRAJE CASTELLANO



BISAGRAS

1, 2
10
12, 12C
44, 44SH
47
50
55,55P

BISAGRAS CIERRE ARCÓN

1A, 2A
10A, 11A
55A, 55PA
Cerradero baúl 110A, 1110A

BISAGRAS MARIPOSA

9
14
15,15P
43
46
60, 60P

BISAGRAS DOBLE COLA

11
48, 48C
50D
65, 65P

019
019
020
020
019
021
019

022
022
022
023

025
025
025
024
024
024

026
026
026
026

BISAGRAS FUERTES

405
404
406

BISAGRAS PORTÓN

700, 700P, 700T
705, 705P, 705T
710, 710P, 710T

BISAGRAS PUERTA

* 3000

BISAGRAS PUERTA DOBLE HOJA

* 526/2, 530/2

BISAGRAS SEGURIDAD

* 1530, 2530, 1540, 2540, 1526, 2526
* 3526, 3530

BISAGRAS ESCUADRA

43E
24CBE

027
027
027

028
029
030

031

031

032
033

024
027

Para más modelos, visita nuestro catálogo de Fragua y Grannoble; www.emiliotortajadasl.com

ACABADOS EN STOCK: 1- NEGRO CASTELLANO / A- ANTICUARIO / P- PLATA VIEJA / 9- RUSTIK / 0- PULIDO

ACABADOS BAJO PEDIDO: 7- BLANCO / 2- LATÓN BRILLO / H- LATÓN MATE / 6- NIQUEL BRILLO / N- NIQUEL MATE / L- BRONCE INGLÉS / C- COBRE BRILLO / 8- ÓXIDO NATURAL / M- FRAGUA / * 3- BICROMATADO / * 4- ZINCADO

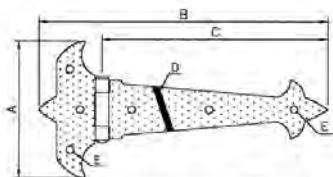

Ref.	A	B	C	D	E
1	59	124	93	1,5	∅4
2	73	155	120	1,5	∅4

Medidas en mm.



1, 2



1Plata



1 Anticuario



1, 2 con Solapo

55, 55P

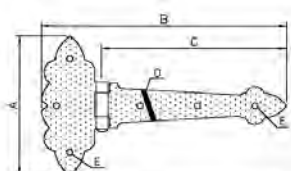

Ref.	A	B	C	D	E
55/P	80	150	117	1,5	∅4
55	92	180	140	1,5	∅4

Medidas en mm.



55, 55P

47



47

10



10

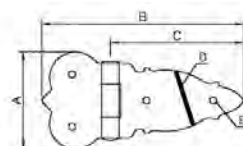

Ref.	A	B	C	D	E
10	23	58	38	1	∅2,5

Medidas en mm.



12



12C

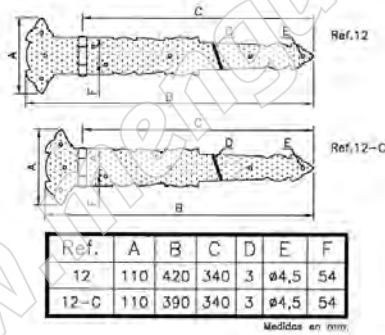

* Pala hembra 28 mm



44



44SH con solapo en la hembra



50



50 con solapo

50E
Para montaje en cemento

50 Anticuario



50 Plata

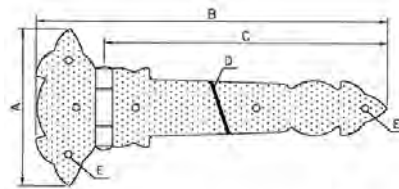

Ref.	A	B	C	D	E
50	110	245	200	2,5	ø5

Medidas en mm.

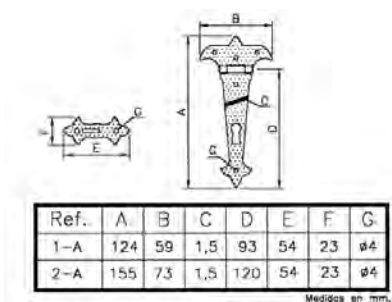
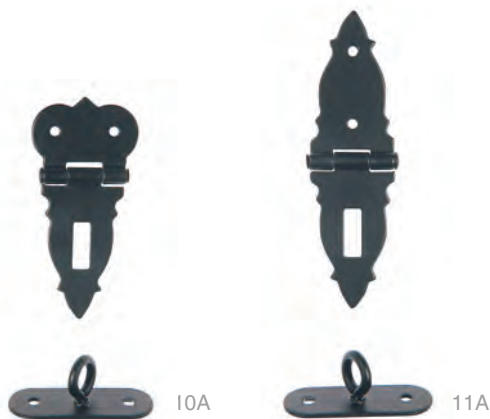
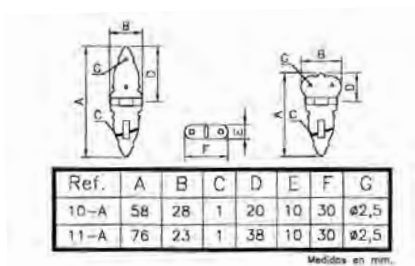

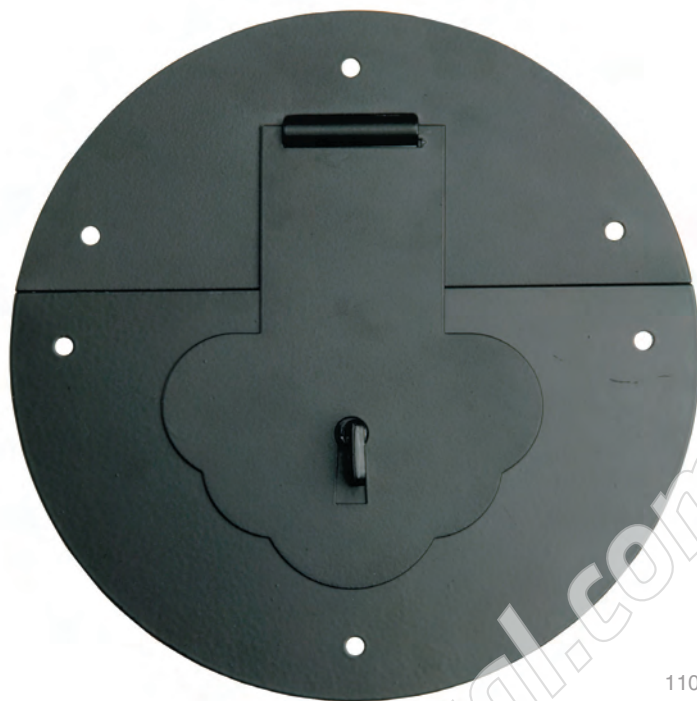

110A

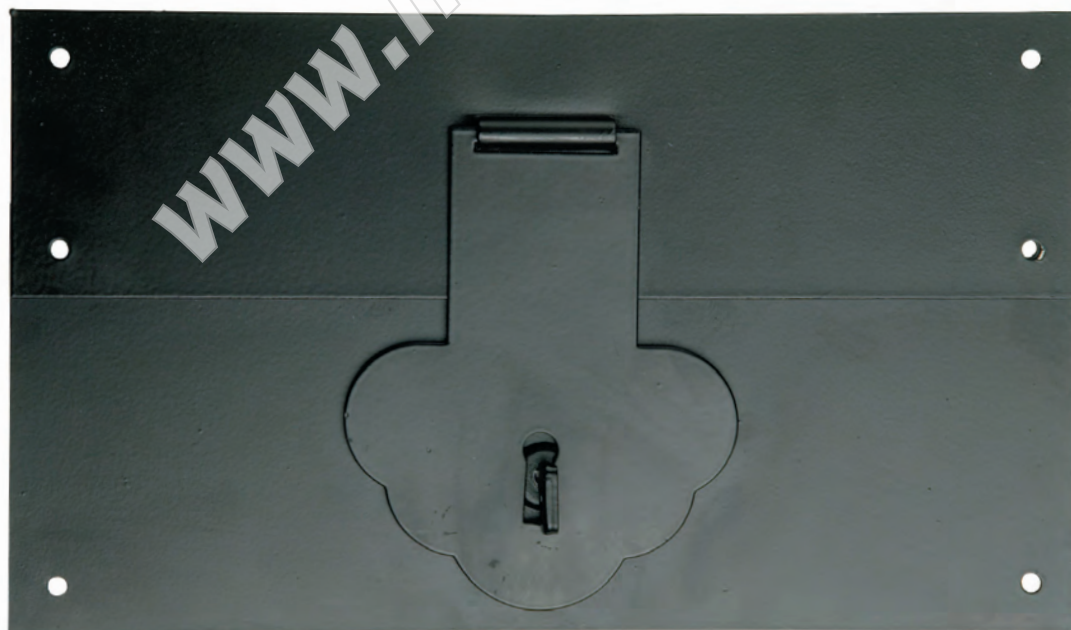

1110A

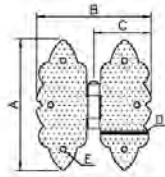

Ref.	A	B	C	D	E
60	92	80	40	1,5	Ø4
60-P	80	64	32	1,5	Ø4

Medidas en mm.



60, 60P



60 con solapo

* Pala 28 mm



43E
Montaje Bisagra-Escuadra con Ref. 70-70P



43

Ref.	A	B	C	D	E
46	100	66	33	2	Ø4

medidas en mm.

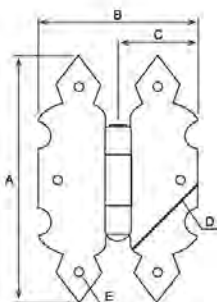

46



46 Níquel Mate

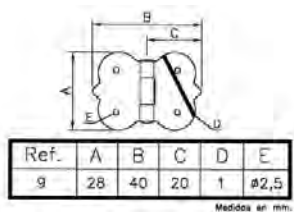

15, 15P

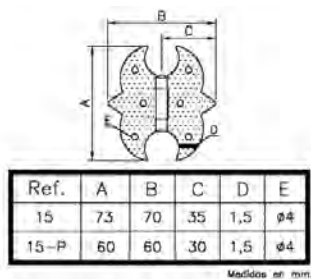

14

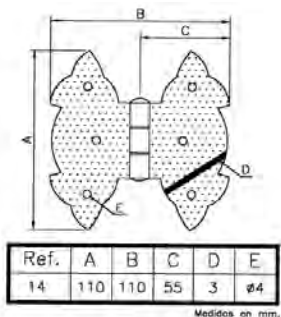



50D

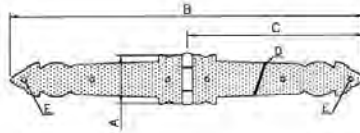

Ref.	A	B	C	D	E
50-D	55	400	200	2,5	∅5

Medidas en mm.

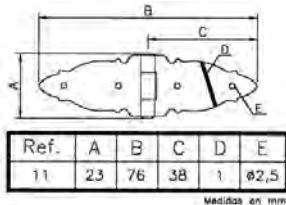

Ref.	A	B	C	D	E
11	23	76	38	1	∅2,5

Medidas en mm.



11

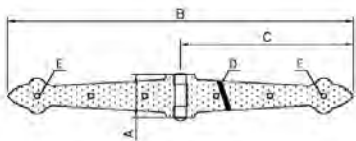

Ref.	A	B	C	D	E
65	30	280	140	1,5	∅4
65-P	30	234	117	1,5	∅4

Medidas en mm.



65, 65P



48



48C

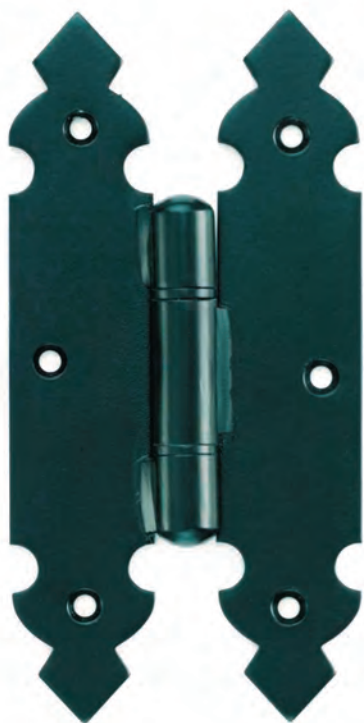

405
Pala: 200x40x4 mm
Ancho total: 98 mm
Fija o desmontable



404
Pala: 126x40x4 mm
Ancho total: 98 mm
Fija o desmontable



406
Pala: 126x40x4 mm
Ancho total: 98 mm
Fija o desmontable



700P
Pala: 153x50x5 mm



700



700T con remate

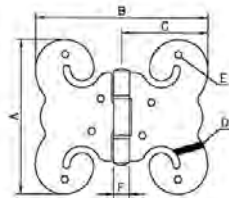

Ref.	A	B	C	D	E	F
700	153	170	B5	5	Ø6,5	Ø18

Medidas en mm.



705P
Pala Hembra: 153x50x5 mm



705T con remate



705

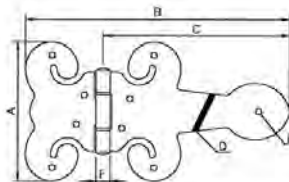

Ref.	A	B	C	D	E	F
705	153	305	220	5	ø6,5	ø18

Medidas en mm.

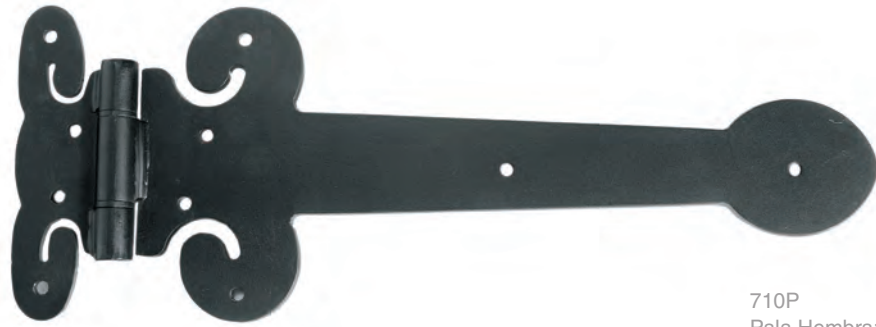

710P
Pala Hembra: 153x50x5 mm



710T con remate



710

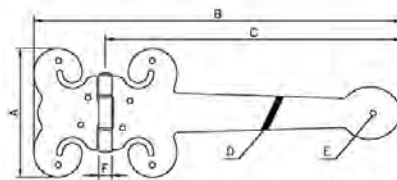

Ref.	A	B	C	D	E	F
710	153	445	360	5	∅6,5	∅18

Medidas en mm.

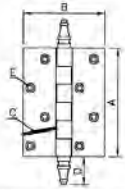

Ref.	A	B	C	D	E
3000	90	60	2	18	Ø5
	100	70	2,5	23	Ø5
	115	90	3	23	Ø5

(90x 60 mm)
 Tipo pernio, guardamano



3000



3000 Latón Brillo

Bisagra Doble Hoja

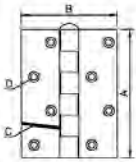

Ref.	A	B	C	D
526/2	100	90	2+2	Ø6
	120	90	2+2	Ø6
	130	100	2+2	Ø6
	140	110	2+2	Ø6
	150	120	2+2	Ø6

Doble hoja

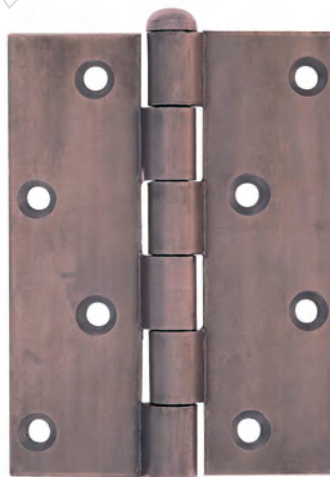

526/2

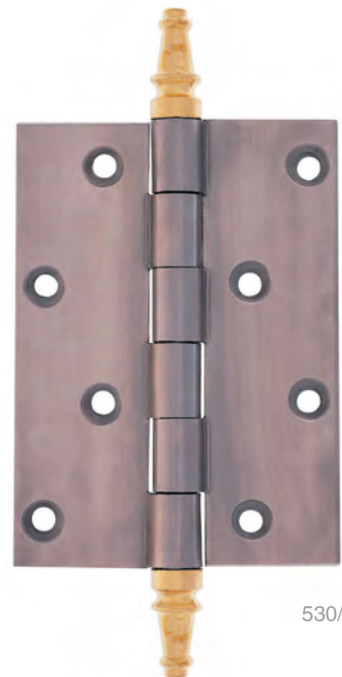

530/2

* Preguntar por más medidas de bisagras de doble hoja y bisagras voladas



1530, 2530 Plata



1540, 2540

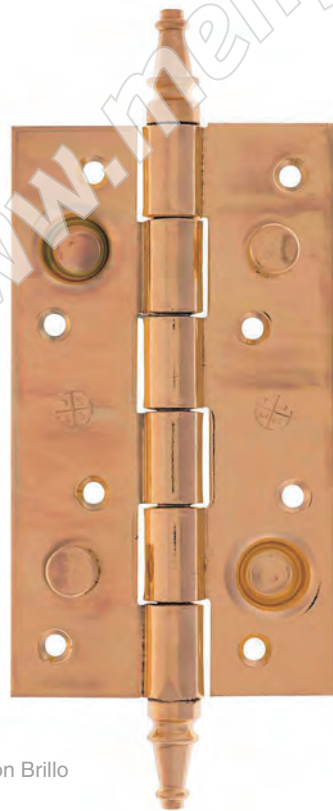

1530, 2530 Latón Brillo

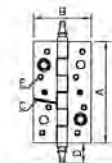

Ref.	A	B	C	D	E
1530	150	85	3	.30	ø5,5
2530	130	85	2+2	.30	ø5
3530	130	85	3	.30	ø5,5

Medidas en mm.

Desmontable,
sin remate Ref. 1526, 2526
2530; Doble hoja

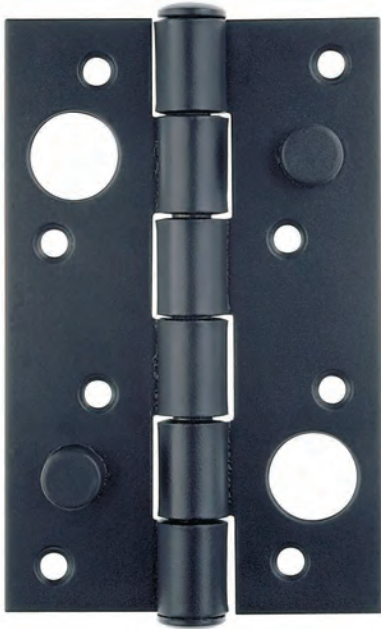

3526

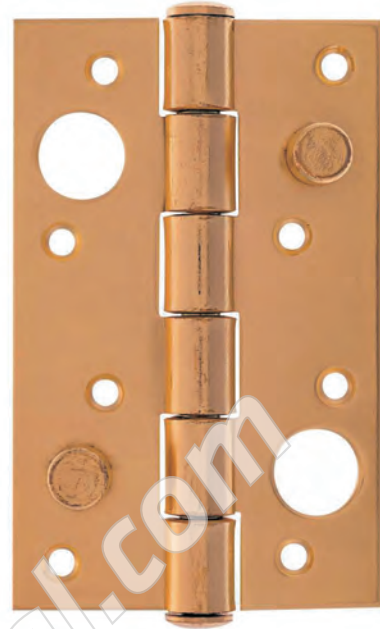

3526 Latón Brillo



3530

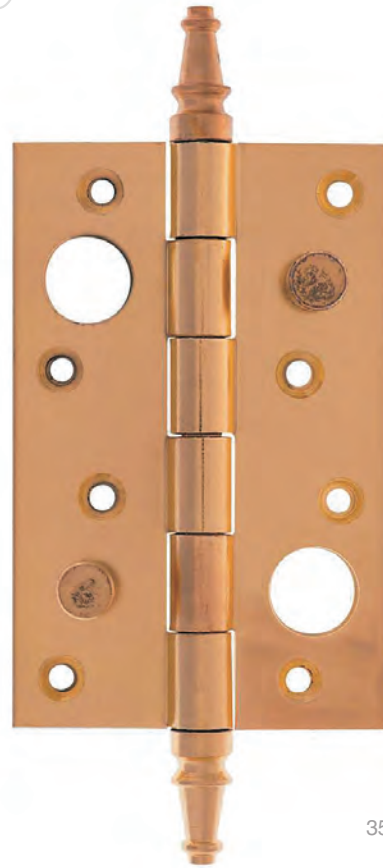

3530 Latón Brillo



Emilio Tortajada, S.L.

www.emiliotortajadasl.com

*Expositores
Expositores
Expositores*



www.emiliotortajadasl.com





Emilio Tortajada, S.L.

www.emiliotortajadasl.com

*Expositores
Expositores
Expositores*



www.emiliotortajadasl.com



GOLFOS

HERRAJE CASTELLANO



GOLFO GARRA

24	037
24C	037
27	037
826 Reforzado	037

GOLFO BISAGRA

24B	038
24CB	039
27B	038
826 Reforzado	038

GOLFO BISAGRA DOBLE EJE

24B Doble eje	039
---------------	-----

GOLFO DOBLE PALA

24D	040
24CD	040
27D	040

GOLFO BASE RECTANGULAR

24M	041
24CM	041
27M	041

GOLFO BASE LANZA

24P	042
24CP	042
27P	042

GOLFO BASE ESTRECHA

24S	043
24CS	043
27S	043

GOLFO BASE TIRAFONDO

24T	044
24CT	044
27T	044

Para más modelos, visita nuestro catálogo de Fragua y Grannoble; www.emiliotortajadasl.com

ACABADOS EN STOCK: 1- NEGRO CASTELLANO / A- ANTICUARIO / P- PLATA VIEJA / 9- RUSTIK / 0- PULIDO

ACABADOS BAJO PEDIDO: 7- BLANCO / 2- LATÓN BRILLO / H- LATÓN MATE / 6- NIQUEL BRILLO / N- NIQUEL MATE / L- BRONCE INGLÉS / C- COBRE BRILLO / 3- BICROMATADO / 4- ZINCADO / 8- ÓXIDO NATURAL / M- FRAGUA

* Para fijar en construcciones de cemento
 Golfo reforzado de 50 mm x 8 mm de espesor Ref.826 con Garra



www.mengual.com

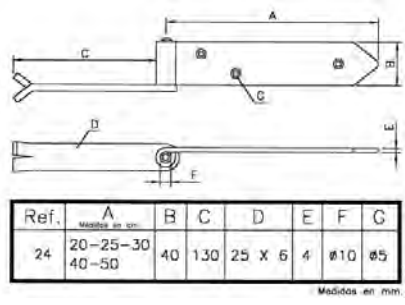
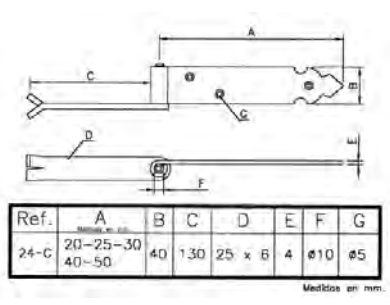

* Fija o desmontable; Guardamano
 Golfo reforzado de 50 mm x 8 mm de espesor Ref.826P



27B



24B

Ref.	A	B	C	D	E	F	G
24-B	20-25-30-40-50	126	40	40	4	Ø 18	Ø 5

medidas en mm.

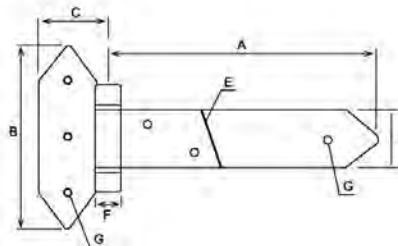

* Fija o desmontable; Guardamano

Ref.	A	B	C	D	E	F	G
24-CB	20-25-30-40-50	200	40	40	4	Ø 18	Ø 5

medidas en mm.

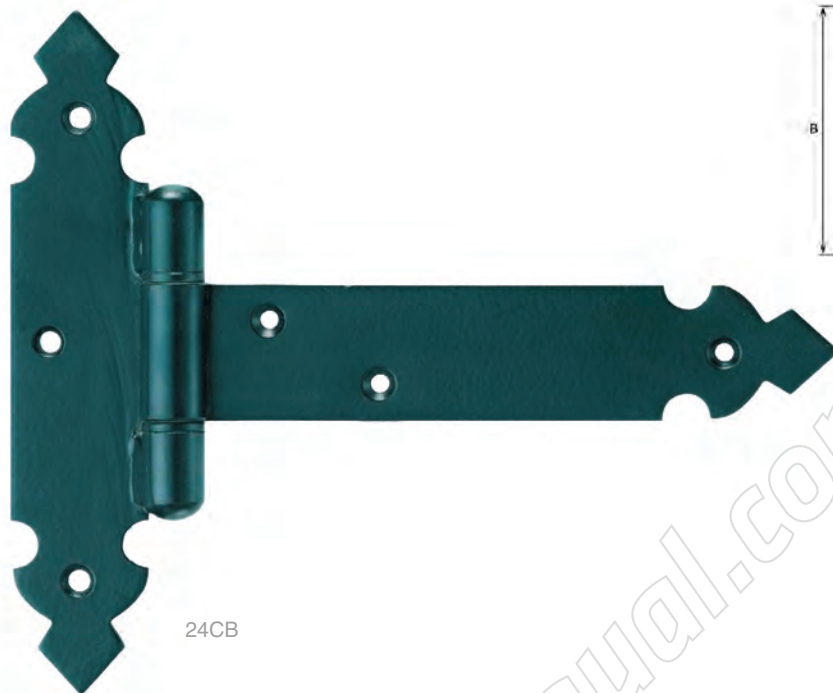
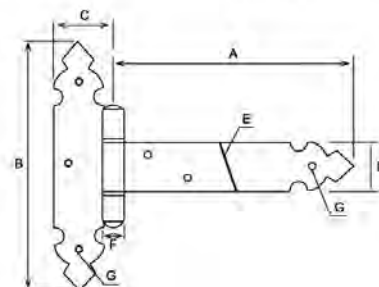

24CB

24B Doble eje

GOLFO BISAGRA DOBLE EJE

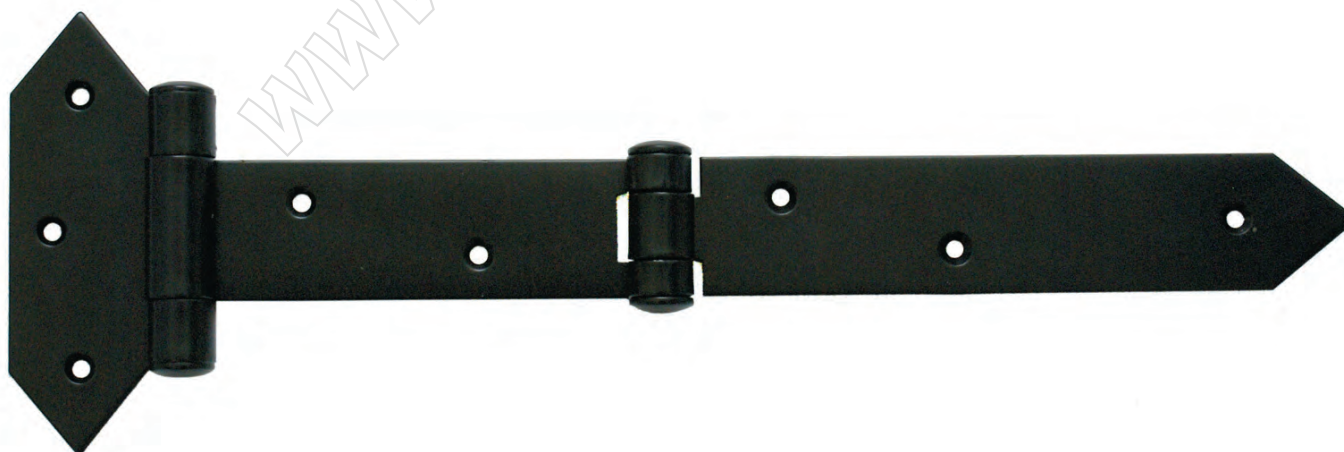

24B Doble eje

* Fija o desmontable; Guardamano



27D



24 D



24CD

Ref.	A	B	C	D	E
24-CD	40	20x20,25x25,30x30,40x40,50x50	4	18	Ø 5

medidas en mm.

Palas intercambiables

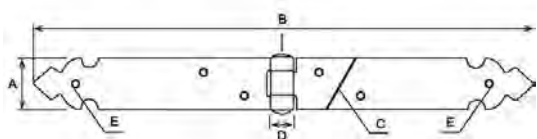

Ref.	A	B	C	D	E
24-D	40	20x20,25x25,30x30,40x40,50x50	4	18	Ø 5

medidas en mm.

Palas intercambiables

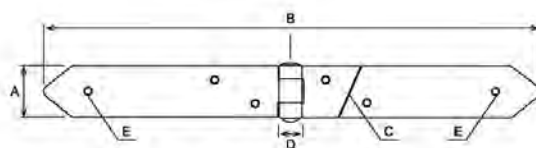

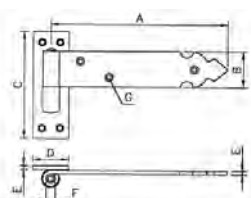

Ref.	A	B	C	D	E	F	G
24-CM	20-25-30	40	120	40	4	ø10	ø5
	40-50						

Medidas en mm.

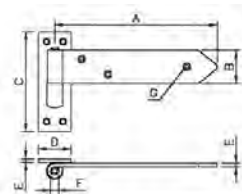

Ref.	A	B	C	D	E	F	G
24M	20-25-30	40	120	40	4	ø10	ø5
	40-50						

Medidas en mm.

* Desmontable; Guardamano

27P



24P



24CP

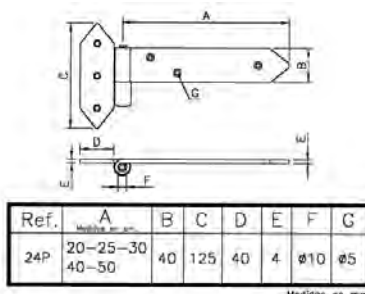
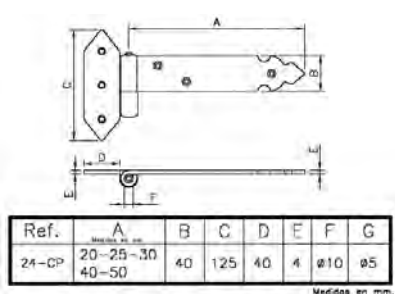

* Base 25 mm

27S



24S



24CS

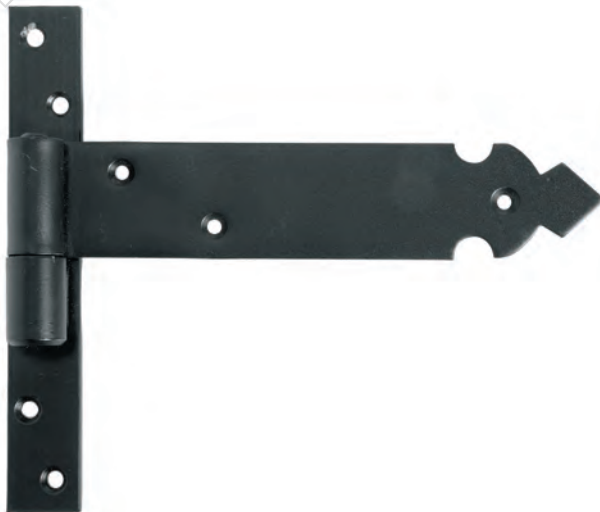



27T



24T



24CT

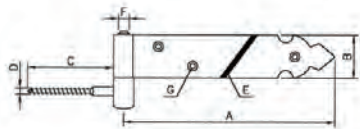

Ref.	A	B	C	D	E	F	G
24-CT	20-25-30	40	80	ø 8	4	ø10	ø5
	40-50						

Medidas en mm.

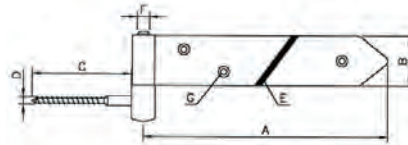

Ref.	A	B	C	D	E	F	G
24-T	20-25-30	40	80	ø8	4	ø10	ø5
	40-50						

Medidas en mm.



PERNIOS

HERRAJE CASTELLANO



PERNIOS CANTO REDONDO

402B, 402T

047

PERNIOS CANTO CUADRADO

403B, 403T

047

PERNIOS ESCUADRA

403BE, 403TE

047

PERNIOS SIN REMATE

402, 403

046

Para más modelos, visita nuestro catálogo de Fragua y Grannoble; www.emiliotortajadasl.com

ACABADOS EN STOCK: 1- NEGRO CASTELLANO / A- ANTICUARIO / P- PLATA VIEJA / 9- RUSTIK / 0- PULIDO

ACABADOS BAJO PEDIDO: 7- BLANCO / 2- LATÓN BRILLO / H- LATÓN MATE / 6- NIQUEL BRILLO / N- NIQUEL MATE / L- BRONCE INGLÉS / C- COBRE BRILLO / 3- BICROMATADO / 4- ZINCADO / 8- ÓXIDO NATURAL / M- FRAGUA

402B, 402T

PERNIOS CANTO REDONDO

* Opción sin remate plano, Ref. 402



Ref.	A	B	C	D	E
402/B	80	46	12	2	∅4
402/B y 402/T	95	56	15	2	∅4
	110	56	15	2	∅4
	140	56	16	2,5	∅4

Medidos en mm.

403B, 403T

PERNIOS CANTO CUADRADO

* Opción sin remate plano, Ref. 403



Ref.	A	B	C	D	E
403/B	80	46	12	2	∅4
403/B y 403/T	95	56	15	2	∅4
	110	56	15	2	∅4
	140	56	16	2,5	∅4

Medidos en mm.

403BE, 403TE

PERNIOS ESCUADRA

* Opción sin remate plano, Ref. 403E

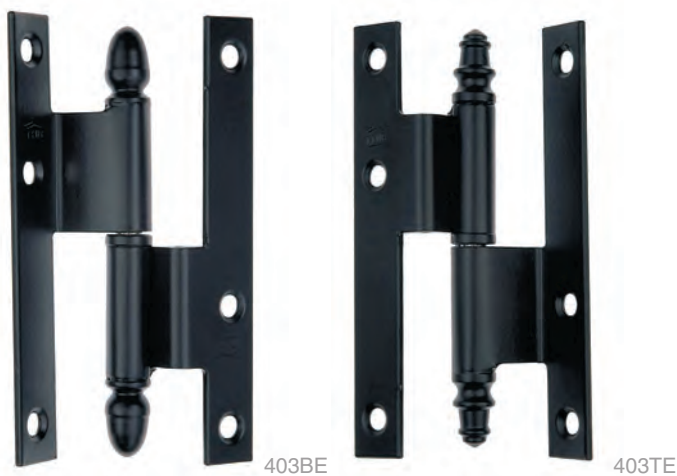

Ref.	A	B	C	D	E	F	G
403-BE y 403-TE	95	15	2	∅10	8	11	∅4

Medidos en mm.

CLAVOS

HERRAJE CASTELLANO

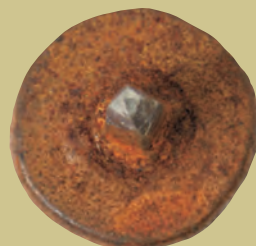

CLAVOS DE CHAPA REDONDO

* 18
* 19
* 1024

047
047
047

CLAVOS DE CHAPA CUADRADO

* 20

047

CLAVOS FUNDIDOS

Felipe II 17
21
22
26

047
047
047
047

CLAVOS RÚSTICOS

* 1021
* 1022
* 1023

047
047
047

Para más modelos, visita nuestro catálogo de Fragua y Grannoble; www.emiliotortajadasl.com

ACABADOS EN STOCK: 1- NEGRO CASTELLANO / A- ANTICUARIO / P- PLATA VIEJA / 9- RUSTIK / 0- PULIDO

ACABADOS BAJO PEDIDO: 7- BLANCO / 2- LATÓN BRILLO / H- LATÓN MATE / 6- NIQUEL BRILLO / N- NIQUEL MATE / L- BRONCE INGLÉS / C- COBRE BRILLO / 3- BICROMATADO / 4- ZINCADO / * 8- ÓXIDO NATURAL / * M- FRAGUA

18, 19, 1024

CLAVOS DE CHAPA REDONDO

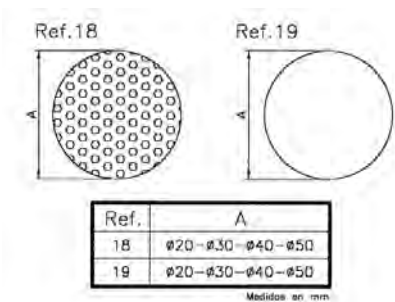

18



19



1024 de 35 mm

20

CLAVOS DE CHAPA CUADRADO

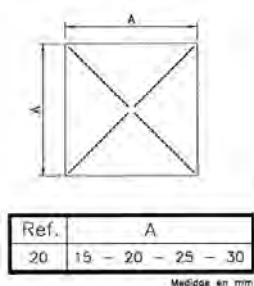

20

Felipe II 17, 21, 22, 26

CLAVOS FUNDIDOS



Felipe II 17

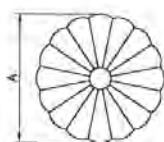

Ref. A
17 Ø36
Medidas en mm.

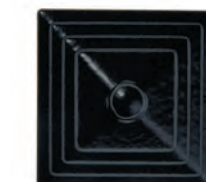

26

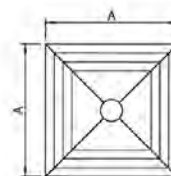

Ref. A
26 30
Medidas en mm.



22
25, 30, 40, 50 mm



21

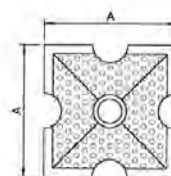

Ref. A
21 25 - 30 - 40 - 50
Medidas en mm.

1021, 1022, 1023

CLAVOS RÚSTICOS



1021
15, 20, 28 mm



1022
12, 15, 18 mm



1023
15, 22, 30 mm



LLAMADORES

HERRAJE CASTELLANO



LLAMADORES

Cónico 620
Felipe II 622
Salomónico 624
Redondo 625

051
051
051
051

Los llamadores pueden ser:

- Montaje tipo tirafondo interior
- Sistema antirrobo (sin tornillos vista)

Para más modelos, visita nuestro catálogo de Fragua y Grannoble; www.emiliotortajadasl.com

ACABADOS EN STOCK: 1- NEGRO CASTELLANO / A- ANTICUARIO / P- PLATA VIEJA / 9- RUSTIK / 0- PULIDO

ACABADOS BAJO PEDIDO: 7- BLANCO / 2- LATÓN BRILLO / H- LATÓN MATE / 6- NIQUEL BRILLO / N- NIQUEL MATE / L- BRONCE INGLÉS / C- COBRE BRILLO / 3- BICROMATADO / 4- ZINCADO



625

Felipe II 622, Cónico 620

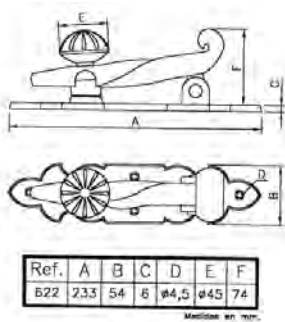

622



620

Salomónico 624

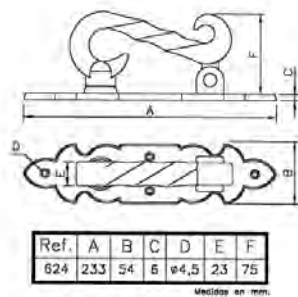

624

MIRILLAS

HERRAJE CASTELLANO



MIRILLAS
830

| 053 |

Para más modelos, visita nuestro catálogo de Fragua y Grannoble; www.emiliotortajadasl.com

ACABADOS EN STOCK: 1- NEGRO CASTELLANO / A- ANTICUARIO / P- PLATA VIEJA / 9- RUSTIK / 0- PULIDO

ACABADOS BAJO PEDIDO: 7- BLANCO / 2- LATÓN BRILLO / H- LATÓN MATE / 6- NIQUEL BRILLO / N- NIQUEL MATE / L- BRONCE INGLÉS / C- COBRE BRILLO / 3- BICROMATADO / 4- ZINCADO



830

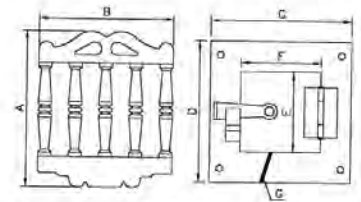

Ref.	A	B	C	D	E	F	G
830	118	103	118	118	60	60	2

Medidas en mm.



ESCUDOS Y BOCALLAVES

HERRAJE CASTELLANO



ESCUDOS Y BOCALLAVES

28	055
90	055
91, 92	057
Rosetas 93, 94, 97, 98	055
104, 104G	056
105, 105G	056
109, 109G	056
131, 132	056
Verona 600	056
99	056

Las bocallaves se pueden fabricar según especificación y medida del cliente

Para más modelos, visita nuestro catálogo de Fragua y Grannoble; www.emiliotortajadasl.com

ACABADOS EN STOCK: 1- NEGRO CASTELLANO / A- ANTICUARIO / P- PLATA VIEJA / 9- RUSTIK / 0- PULIDO

ACABADOS BAJO PEDIDO: 7- BLANCO / 2- LATÓN BRILLO / H- LATÓN MATE / 6- NIQUEL BRILLO / N- NIQUEL MATE / L- BRONCE INGLÉS / C- COBRE BRILLO / 3- BICROMATADO / 4- ZINCADO / 8- ÓXIDO NATURAL / M- FRAGUA



90, 91, 92

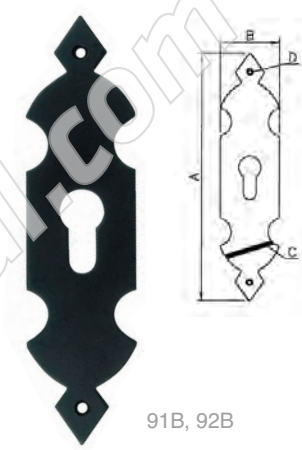
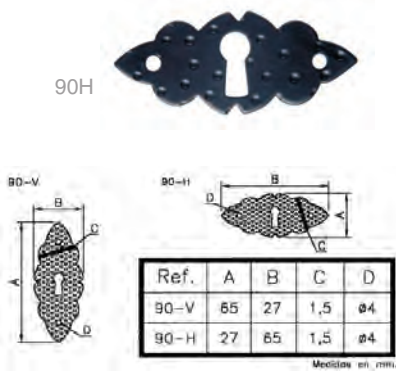

Ref.	A	B	C	D
91B	175	45	2	ø4
92B	175	45	2	ø4

Medidas en mm.

Rosetas 93, 94, 97, 98



97B

98B

Níquel mate

Latón brillo

Óxido



104, 104G 105, 105G

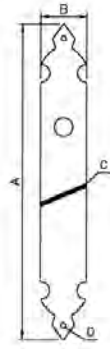

Ref.	A	B	C	D
104	275	40	2	ø4
104-G	285	45	2	ø4
105	275	40	2	ø4
105-G	285	45	2	ø4

Medidas en mm.

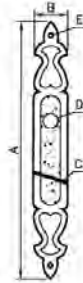

Ref.	A	B	C	D	E
109	305	40	2	ø16	ø4
109-G	325	50	2	ø16	ø4

Medidas en mm.



109, 109G

99



99

600 Verona



600 Verona

131, 132



131 Martilleado
132 Liso

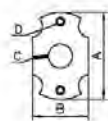

Ref.	A	B	C	D
97	70	45	2	∅4
98	70	45	2	∅4

Medidas en mm.



97, 98



93



29

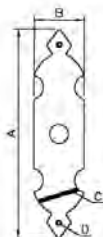

Ref.	A	B	C	D
91	175	45	2	∅4
92	175	45	2	∅4

Medidas en mm.



91, 92



94

Emilio Tortajada, S.L.

Cerrajería Mecánica - Herraje Castellano

Desde 1886

100% HECHO EN ESPAÑA



MODELO MHB1. Patentado
Prensa electrohidráulica
para troquelar bocallaves

Dimensiones: 900x500x1000 mm.
Peso: 302 Kg.

Consultar condiciones de venta

MANIVELAS

HERRAJE CASTELLANO

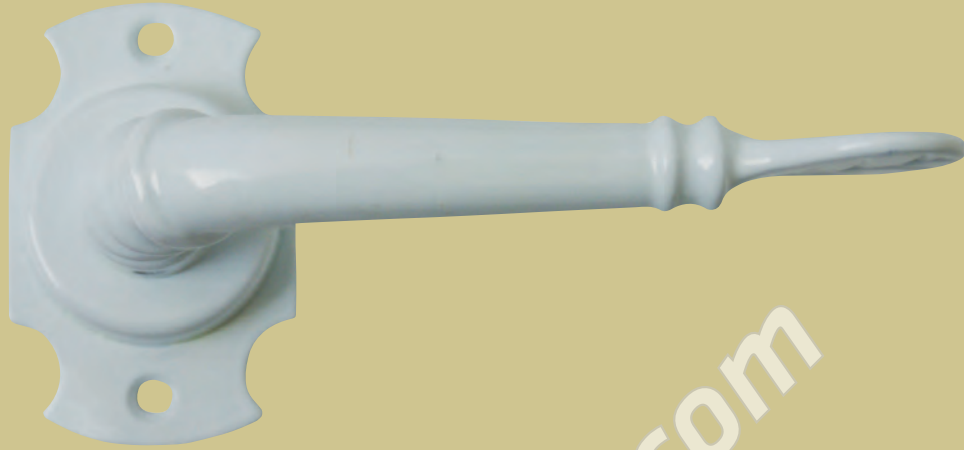

MANIVELAS AUTOMÁTICAS CON MUELLE

Espiral 200	059
Cisne 201	060
* Italy 220	061
Pomo 222	065
* Oval 230	064
Salomónica 240	063
Trébol 250	066
Felipe II 260	067
Verona 270	068
* Farolillo 290	062

MANIVELAS GRISÁN Y OSCIOBATIENTES

Espiral 100	070
Cisne 101	070
* Italy 120	071
Salomónica 140	071
Trébol 150	071
* Mecanismo oscilobatiente 190	070

MANIVELAS MANUALES SIN MUELLE

Espiral 100	072
Cisne 101	072
* Italy 120	073
Pomo 123	072
* Oval 130	072
Salomónica 140	072
Trébol 150	073
Felipe II 160	073
Verona 170	073
* Farolillo 190	073

Para más modelos, visita nuestro catálogo de Fragua y Grannoble; www.emiliotortajadasl.com

ACABADOS EN STOCK: 1- NEGRO CASTELLANO / A- ANTICUARIO / P- PLATA VIEJA / 9- RUSTIK / 0- PULIDO

ACABADOS BAJO PEDIDO: 7- BLANCO / 2- LATÓN BRILLO / H- LATÓN MATE / 6- NIQUEL BRILLO / N- NIQUEL MATE / L- BRONCE INGLÉS / C- COBRE BRILLO / 3- BICROMATADO / 4- ZINCADO / * 8- ÓXIDO NATURAL / * M- FRAGUA



200/91



200/92

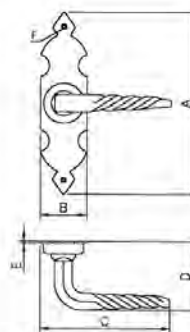

Ref.	A	B	C	D	E	F
200/91	175	45	120	70	2	∅4
200/92	175	45	120	70	2	∅4
C/B	190	45	120	70	2	∅4

Medidas en mm.



200/97



200/98

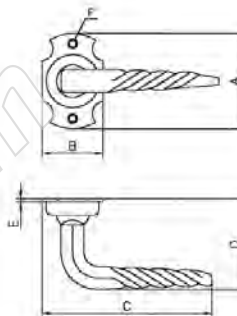

Ref.	A	B	C	D	E	F
200/97	70	45	120	70	2	∅5
200/98	70	45	120	70	2	∅5

Medidas en mm.



200/104
200/104G



200/105
200/105G

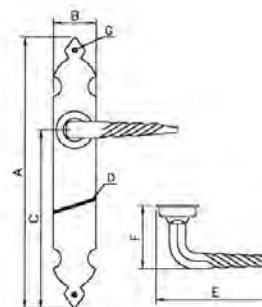

Ref.	A	B	C	D	E	F	G
200/104	275	40	185	2	120	70	∅4
200/105	275	40	185	2	120	70	∅4
200/104G	285	45	190	2	122	70	∅4
200/105G	285	45	190	2	122	70	∅4

Medidas en mm.



200/109
200/109G

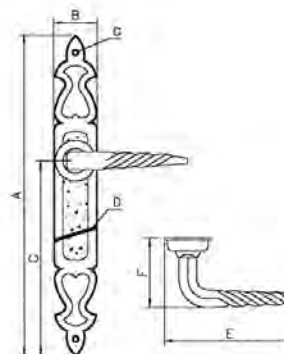

Ref.	A	B	C	D	E	F	G
200/109	305	40	187	2	120	70	∅4
200/109G	325	50	190	2	125	70	∅4

Medidas en mm.





201/91
201/92

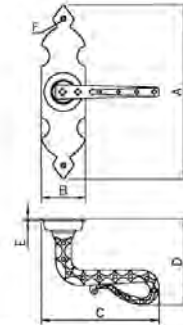

Ref.	A	B	C	D	E	F
201/91	175	45	120	90	2	ø4
201/92	175	45	120	90	2	ø4
C/B	190	45	120	90	2	ø4

Medidas en mm.



201/97



201/98

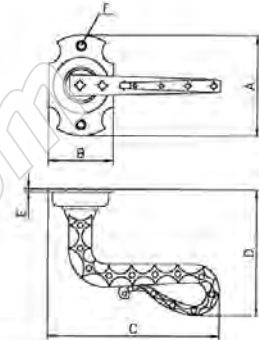

Ref.	A	B	C	D	E	F
201/97	70	45	120	90	2	ø5
201/98	70	45	120	90	2	ø5

Medidas en mm.



201/104
201/104G



201/105
201/105G

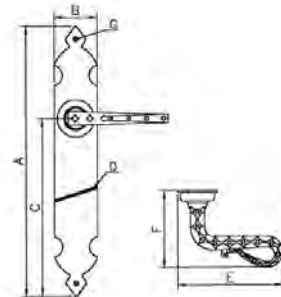

Ref.	A	B	C	D	E	F	G
201/104	275	40	185	2	120	88	ø4
201/105	275	40	185	2	120	88	ø4
201/104G	285	45	190	2	122	88	ø4
201/105G	285	45	190	2	122	88	ø4

Medidas en mm.

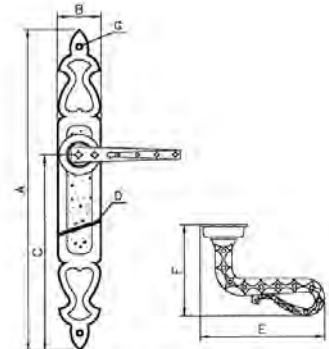

Ref.	A	B	C	D	E	F	G
201/109	305	40	187	2	120	88	ø4
201/109G	325	50	190	2	125	88	ø4

Medidas en mm.



220/92



220/98



220/105
220/105G



220/99



220/131 Anticuario



220/132





240/91



240/92



240/97



240/98



240/104
240/104G



240/105
240/105G

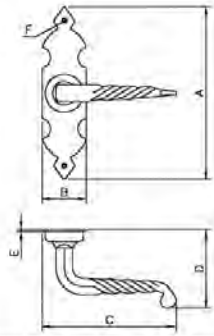

Ref.	A	B	C	D	E	F
240/91	175	45	140	82	2	∅4
240/92	175	45	140	82	2	∅4
C/B	190	45	140	82	2	∅4

Medidas en mm.

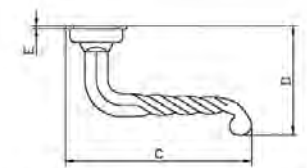
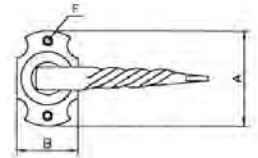

Ref.	A	B	C	D	E	F
240/97	70	45	140	82	2	∅5
240/98	70	45	140	82	2	∅5

Medidas en mm.

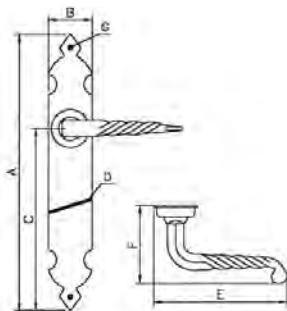

Ref.	A	B	C	D	E	F	G
240/104	275	40	185	2	140	82	∅4
240/105	275	40	185	2	140	82	∅4
240/104G	285	45	190	2	142	82	∅4
240/105G	285	45	190	2	142	82	∅4

Medidas en mm.

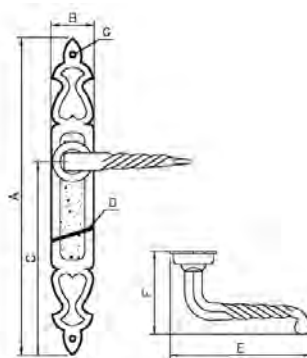

Ref.	A	B	C	D	E	F	G
240/109	305	40	187	2	140	82	∅4
240/109G	325	50	190	2	145	82	∅4

Medidas en mm.



240/109
240/109G



230/91



230/92

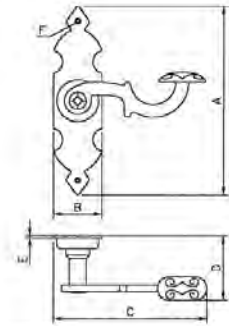

Ref.	A	B	C	D	E	F
230/91	175	45	140	65	2	ø4
230/92	175	45	140	65	2	ø4
C/B	190	45	140	65	2	ø4

Medidas en mm.



230/97



230/98

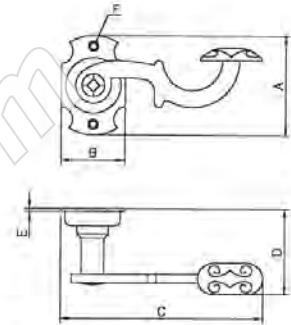

Ref.	A	B	C	D	E	F
230/97	70	45	140	65	2	ø5
230/98	70	45	140	65	2	ø5

Medidas en mm.



230/104
230/104G



230/105
230/105G

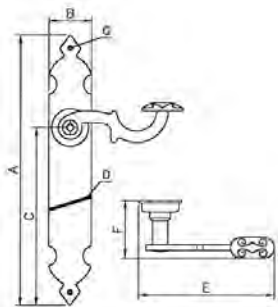

Ref.	A	B	C	D	E	F	G
230/104	275	40	185	2	140	65	ø4
230/105	275	40	185	2	140	65	ø4
230/104G	285	45	190	2	142	65	ø4
230/105G	285	45	190	2	142	65	ø4

Medidas en mm.

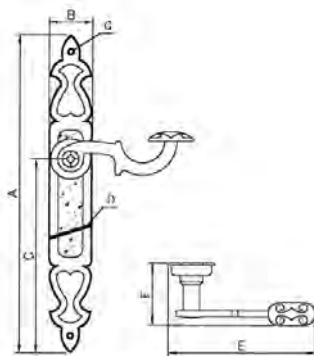

Ref.	A	B	C	D	E	F	G
230/109	305	40	187	2	140	65	ø4
230/109G	325	50	190	2	145	65	ø4

Medidas en mm.



230/109
230/109G

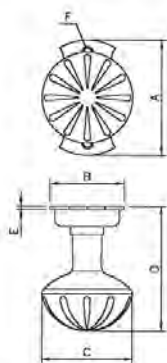

Ref.	A	B	C	D	E	F
222/97	70	45	55	75	2	∅5
222/98	70	45	55	75	2	∅5

Medidas en mm.

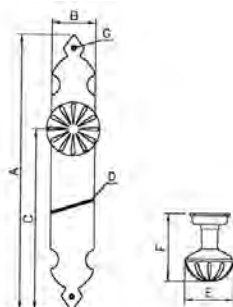

Ref.	A	B	C	D	E	F	G
222/104	275	40	185	2	55	75	∅4
222/105	275	40	185	2	55	75	∅4
222/104G	285	45	190	2	55	75	∅4
222/105G	285	45	190	2	55	75	∅4

Medidas en mm.

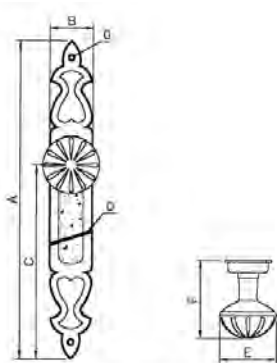

Ref.	A	B	C	D	E	F	G
222/109	305	40	187	2	55	75	∅4
222/109G	325	50	190	2	55	75	∅4

Medidas en mm.

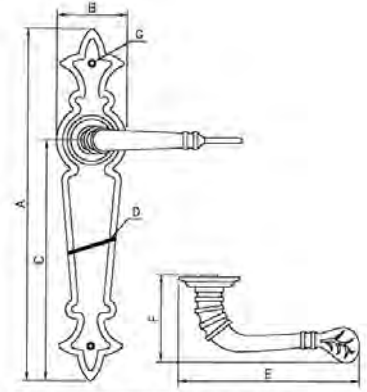

Ref.	A	B	C	D	E	F	G
250	287	57	197	1,5	148	70	ø4

Medidas en mm.

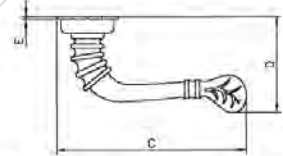
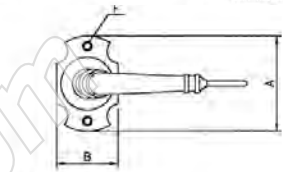

Ref.	A	B	C	D	E	F
250/97	70	45	140	72	2	ø5
250/98	70	45	140	72	2	ø5

Medidas en mm.

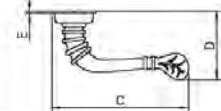
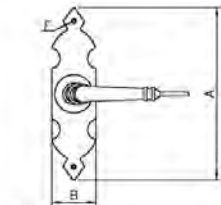

Ref.	A	B	C	D	E	F
250/91	175	45	140	72	2	ø4
250/92	175	45	140	72	2	ø4
C/B	190	45	140	72	2	ø4

Medidas en mm.

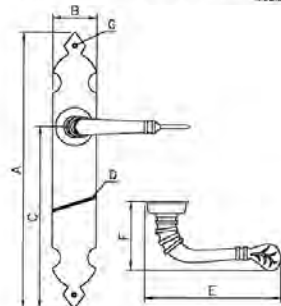

Ref.	A	B	C	D	E	F	G
250/104	275	40	185	2	140	72	ø4
250/105	275	40	185	2	140	72	ø4
250/104C	285	45	190	2	142	72	ø4
250/105G	285	45	190	2	142	72	ø4

Medidas en mm.

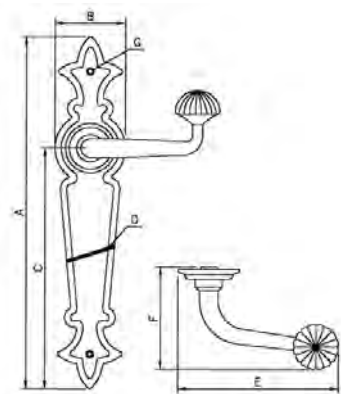

Ref.	A	B	C	D	E	F	G
260	287	57	197	1,5	130	B3	Ø4

Medidas en mm.

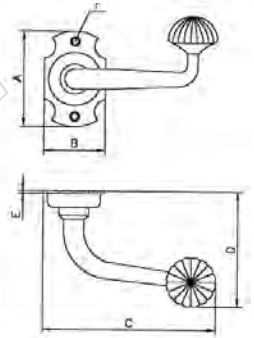

Ref.	A	B	C	D	E	F
260/97	70	45	125	85	2	Ø5
260/98	70	45	125	85	2	Ø5

Medidas en mm.

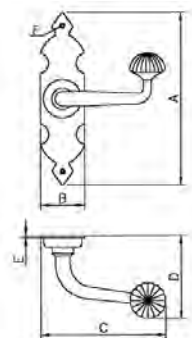

Ref.	A	B	C	D	E	F
260/91	175	45	125	85	2	Ø4
260/92	175	45	125	85	2	Ø4
C/B	190	45	125	85	2	Ø4

Medidas en mm.

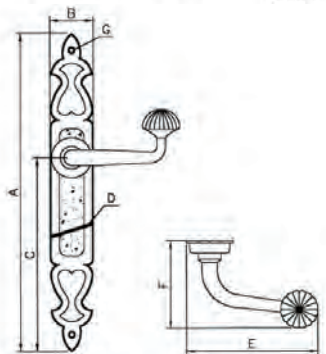

Ref.	A	B	C	D	E	F	G
260/109	305	40	187	2	125	85	Ø4
260/109G	325	50	190	2	130	85	Ø4

Medidas en mm.



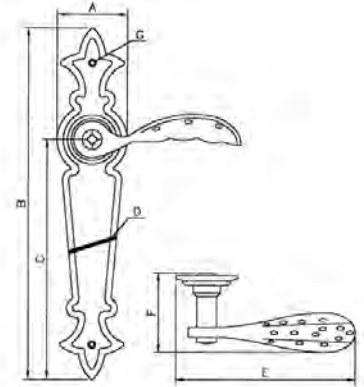

Ref.	A	B	C	D	E	F	G
600	57	287	197	1,5	150	64	ø4

Medidas en mm.

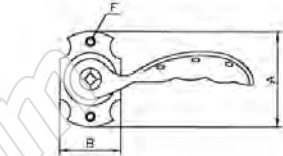

Ref.	A	B	C	D	E	F
270/97	70	45	145	66	2	ø5
270/98	70	45	145	66	2	ø5

Medidas en mm.

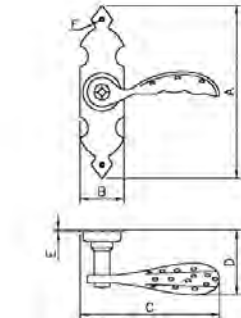

Ref.	A	B	C	D	E	F
270/91	175	45	145	66	2	ø4
270/92	175	45	145	66	2	ø4
c/B	190	45	145	66	2	ø4

Medidas en mm.



270/109G



270/104G



270/105G

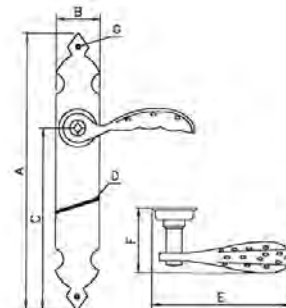

Ref.	A	B	C	D	E	F	G
270/104	275	40	185	2	145	66	ø4
270/105	275	40	185	2	145	66	ø4
270/104G	285	45	190	2	147	66	ø4
270/105G	285	45	190	2	147	66	ø4

Medidas en mm.

GAMA DE ACABADOS



Plata Vieja



Blanco



Anticuaria



Óxido Natural



Latón Brillo

100/29
100/108P

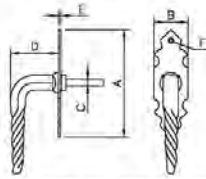

Ref.	A	B	C	D	E	F
100/29	100	32	∅ 6-7-8	55	2	∅4
100/108-P	150	32	∅ 6-7-8	55	2	∅4

Medidas en mm.



100/29-45
Grisán Europeo.
Distancia 45 mm entre ejes

Cisne 101

Mecanismo Oscilobatiente 190



101/29
101/108P

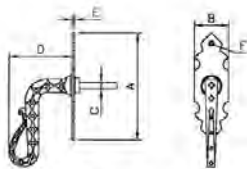

Ref.	A	B	C	D	E	F
101/29	100	32	∅ 6-7-8	78	2	∅4
101/108-P	150	32	∅ 6-7-8	78	2	∅4

Medidas en mm.





140/29-45
Grisán Europeo
Distancia 45 mm entre ejes

140/29
140/108P

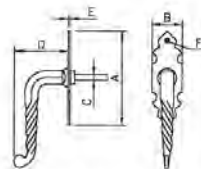

Ref.	A	B	C	D	E	F
140/29	100	32	∅ 6-7-8	67	2	∅4
140/108-P	150	32	∅ 6-7-8	67	2	∅4

Medidas en mm.

Trébol 150



150/29
150/108P

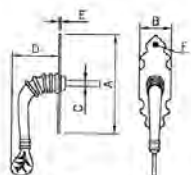

Ref.	A	B	C	D	E	F
150/29	100	32	∅ 6-7-8	47	2	∅4
150/108-P	150	32	∅ 6-7-8	47	2	∅4

Medidas en mm.

Italy 120



120/99P



120/27 Escudo Liso
120/27M Escudo Martilleado



130

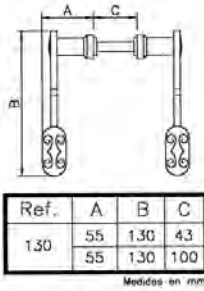

123

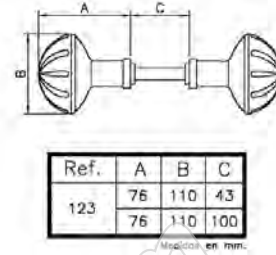

100

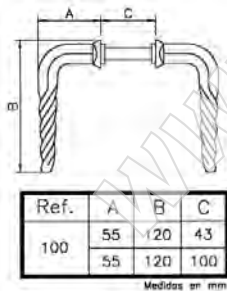

101

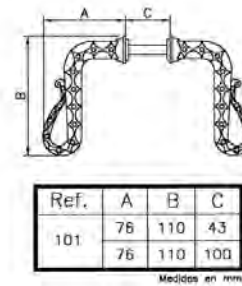

140

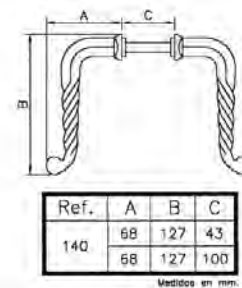

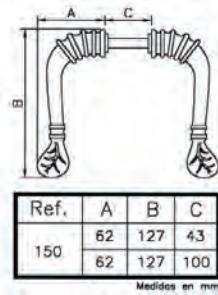

Felipe II 160



160

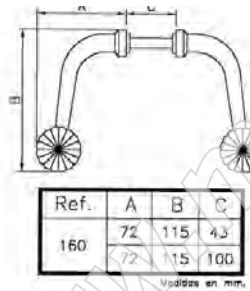

Farolillo 190



190

Verona 170



170

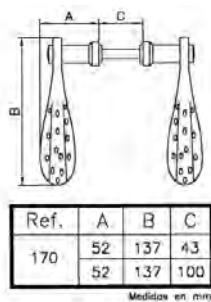

Italy 120



120

POMOS

HERRAJE CASTELLANO



POMOS FIJOS PUERTA

119
125 Felipe II
* 126
* 135 Italy
122

075
075
075
075
075

POMOS FIJOS O MOVIBLES PUERTA

122/ 97, 98 Escudo roseta
122/ 91, 92
122/ 104/ 104G/ 105/ 105G
122/109/ 109G

076
076
077
077

Para más modelos, visita nuestro catálogo de Fragua y Grannoble; www.emiliotortajadasl.com

ACABADOS EN STOCK: 1- NEGRO CASTELLANO / A- ANTICUARIO / P- PLATA VIEJA / 9- RUSTIK / 0- PULIDO

ACABADOS BAJO PEDIDO: 7- BLANCO / 2- LATÓN BRILLO / H- LATÓN MATE / 6- NIQUEL BRILLO / N- NIQUEL MATE / L- BRONCE INGLÉS / C- COBRE BRILLO / 3- BICROMATADO / 4- ZINCADO / * 8- ÓXIDO NATURAL / * M- FRAGUA



126

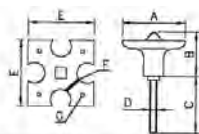

Ref.	A	B	C	D	E	F	G
119	70	48	60	M-8	70	1.5	ø4

Medidas en mm.



119

125 Felipe II



125 Plata



125 Anticuario



125 Latón Brillo



Ref.	A	B	C	D	E
125	74	72	60	M-6	70-100

Medidas en mm.



122

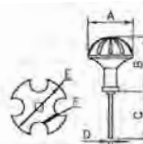

Ref.	A	B	C	D	E	F
122	55	65	55	M-8	ø 70	1.5

Medidas en mm.



135



122/97



122/98

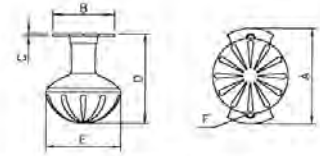

Ref.	A	B	C	D	E	F
122/97	70	45	2	66	55	∅4
122/98	70	45	2	66	55	∅4

Medidas en mm.

Escudo roseta



122/91



122/92

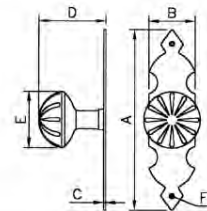

Ref.	A	B	C	D	E	F
122/91	175	45	2	66	55	∅4
122/92	175	45	2	66	55	∅4

Medidas en mm.

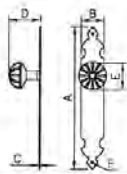

Ref.	A	B	C	D	E	F
122/104	275	40	2	66	55	∅5
122/105	275	40	2	66	55	∅5
122/104-G	285	45	2	66	55	∅5
122/105-G	285	45	2	66	55	∅5

Medidas en mm.



122/104
122/104G



122/105
122/105G



122/109
122/109G

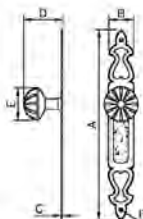

Ref.	A	B	C	D	E	F
122/109	305	40	2	66	55	∅4
122/109-G	325	50	2	66	55	∅4

Medidas en mm.

CONDENAS Y MULETILLAS

HERRAJE CASTELLANO

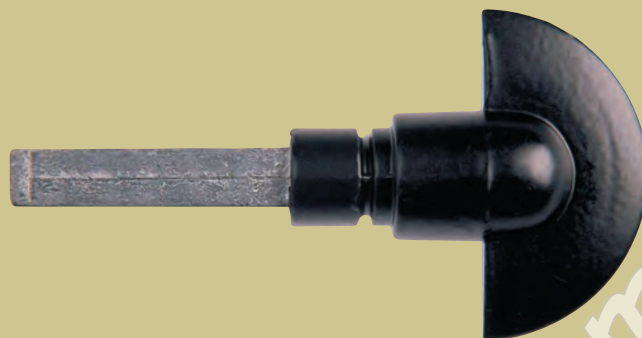

CONDENAS

40/ 29
41/ 29

079
079

MULETILLAS

Felipe II 40
Plana 41

079
079

MULETILLAS CON DESBLOQUEO

Canarias 42

079

Para más modelos, visita nuestro catálogo de Fragua y Grannoble; www.emiliotortajadasl.com

ACABADOS EN STOCK: 1- NEGRO CASTELLANO / A- ANTICUARIO / P- PLATA VIEJA / 9- RUSTIK / 0- PULIDO

ACABADOS BAJO PEDIDO: 7- BLANCO / 2- LATÓN BRILLO / H- LATÓN MATE / 6- NIQUEL BRILLO / N- NIQUEL MATE / L- BRONCE INGLÉS / C- COBRE BRILLO / 3- BICROMATADO / 4- ZINCADO



40/29



41/29

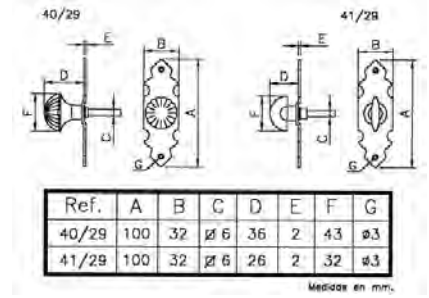

Felipe II 40

Plana 41

MULETILLAS



40



41

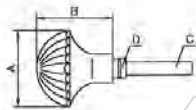

Ref.	A	B	C	D
40	33	35	∅ 6	∅ 10

Medidas en mm.

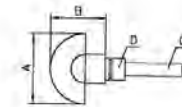

Ref.	A	B	C	D
41	32	26	∅ 6	∅ 10

Medidas en mm.

Canarias 42

MULETILLAS CON DESBLOQUEO



42

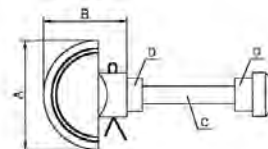

Ref.	A	B	C	D
42	50	38	∅ 6	∅ 15,5

Medidas en mm.

CERROJOS

HERRAJE CASTELLANO

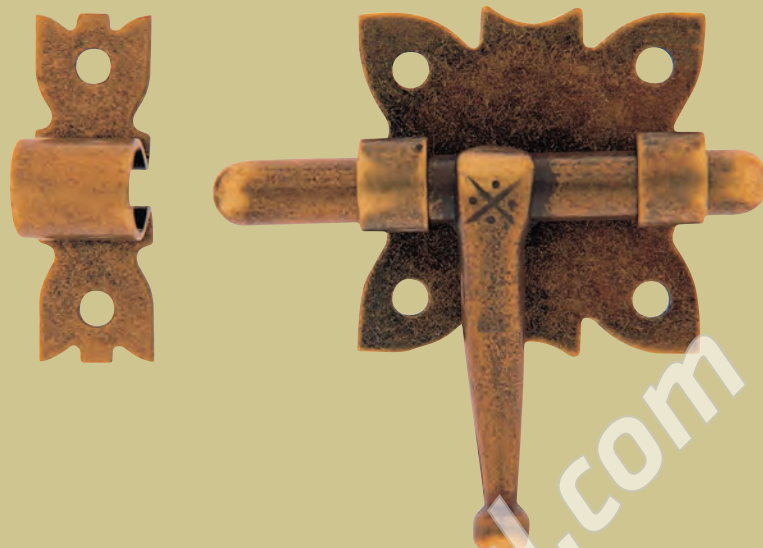

CERROJOS

Estilo 45, 45P
Estilo 84R
* Felipe II 85R

081
081
081

CERROJILLO FUERTE

* 384

082

CERROJO GIRATORIO

* 454
* 454C

082
082

CERROJO GIRATORIO PARA SOLDAR CON AGUJERO CANDADO

* 455
* 455C

082
082

Para más modelos, visita nuestro catálogo de Fragua y Grannoble; www.emiliotortajadasl.com

ACABADOS EN STOCK: 1- NEGRO CASTELLANO / A- ANTICUARIO / P- PLATA VIEJA / 9- RUSTIK / 0- PULIDO

ACABADOS BAJO PEDIDO: 7- BLANCO / 2- LATÓN BRILLO / H- LATÓN MATE / 6- NIQUEL BRILLO / N- NIQUEL MATE / L- BRONCE INGLÉS / C- COBRE BRILLO / *3- BICROMATADO / * 4- ZINCADO / * 8- ÓXIDO NATURAL / * M- FRAGUA

Estilo 45, 45P

CERROJOS

* Opción gafa alta. GA



45, 45P

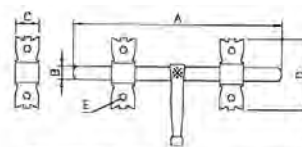

Ref.	A	B	C	D	E
45	160	∅12	15	54	∅4
45-P	125	∅11	15	54	∅4

Medidas en mm.

Estilo 84R

* Opción gafa alta. GA



84R

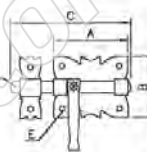

Ref.	A	B	C	D	E
40	42	65	∅8	∅4	
50	42	80	∅8	∅4	
60	46	95	∅9	∅4	
70	47	106	∅10	∅4	
80	56	124	∅11	∅4	
100	57	160	∅12	∅4	

Medidas en mm.

Felipe II 85R



85R

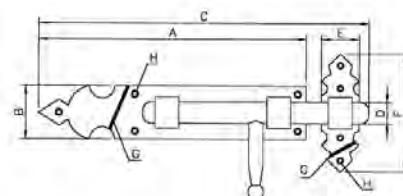

Ref.	A	B	C	D	E	F	G	H
85-R	225	45	280	∅18	32	100	2	∅4

Medidas en mm.



Fabricando en España desde 1886

* Opción Gafa Alta GA

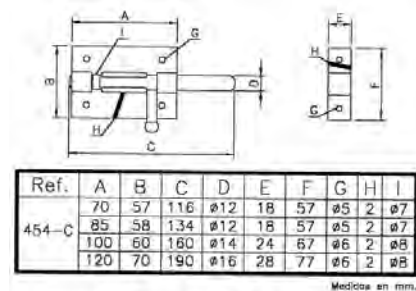
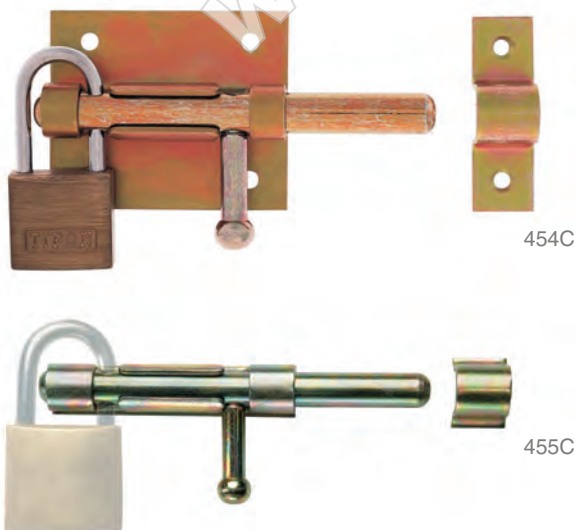
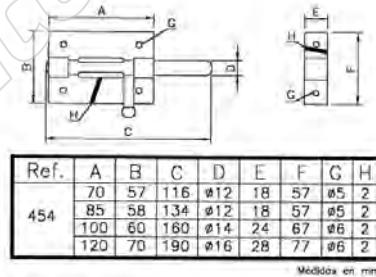
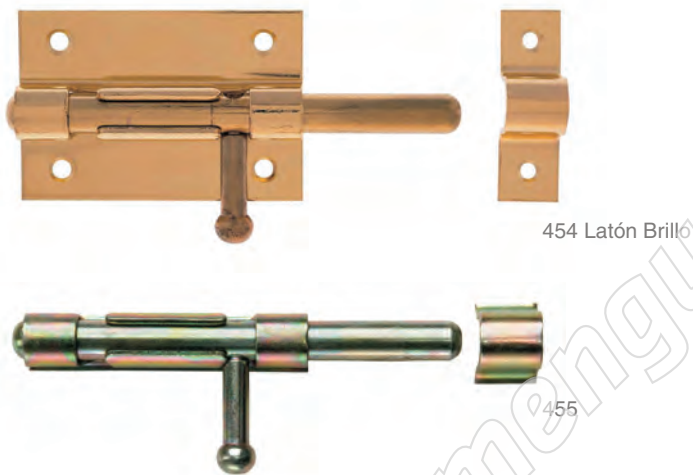
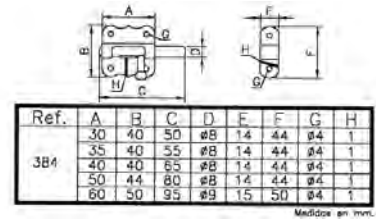

El equipo humano de **EMILIO TORTAJADA S.L.** está compuesto por una amplia red de compañeros y colaboradores cuyo compromiso con la empresa, los clientes y el desarrollo están presentes en su día a día, para ofrecerles nuestros mejores servicios.

Contamos con 17 Agentes Comerciales repartidos por todo el territorio Nacional que ayudan a convertir a la empresa en el referente que es hoy en día.

AGENTES COMERCIALES

Comunidad Valenciana y Palma de Mallorca

Antonio López, Mv:607082900, Mario López, Mv: 663105019
a.lopez5@cgac.es, mlfcomercial@gmail.com

Catalunya y Andorra: Unirep&Alonso, S.L

Fermin, Mv: 656804043, Alonso, Mv: 639763388
alonso@unirep.es, fermi@unirep.es, ventas@unirep.es

Galicia: Pedro Marcelo Tomé Hernando

Pedro, Mv: 607707065, Telf.: +34 986890930
retomefe@gmail.com

Sevilla y Huelva: Cerema, S.C

Manolo Cuevas, Mv: 629512169, Telf.:+34 954439988
cerema@cerema.es

Aragón: López Lacalle, S.C

Alberto, Mv: 607413249, Juan Carlos, Mv: 607413249
representaciones@lopezlacalle.es

Cádiz: Eugenio Jaén Guerra

Eugenio, Mv: 649493625, Telf.:+34 956335863
representaciones_jaen@hotmail.com

La Rioja, Navarra y Soria: Francisco Judez Maestu

Francisco, Mv: 639848519, Telf.:+34 941261178
f.judez@cgac.es

Asturias: Bernardo Representaciones y Exclusivas, S.L

Bernardo, Mv: 609876747, Telf.:+34 985792988

Sta. Cruz de Tenerife: Palmero Representaciones, S.L

Benjamín, Mv: 609502121, Telf.:+34 922534146
benjamin@palmero.es

País Vasco: Fernando Calleja

Fernando, Mv: 672715512
fernandocalleja@gmail.com

Córdoba, Málaga, Jaén y Granada: Representaciones Javier Luque

Javier, Mv: 605210899, Telf.:+34 957787936
javierluque2@yahoo.es

Extremadura: Félix Mera Gallardo

Félix, Mv: 657859166, Telf.: +34 924248825
felixmeragallardo@gmail.com

Madrid, Salamanca, Toledo, Ávila, Segovia:

Representaciones Tecnoferro, S.L

Fernando, Mv: 670912296, Jose, Mv: 651813306
flopezalcala255@telefonica.net, joseacuina1@hotmail.com

Ciudad Real: Víctor Gormaz Hungría

Víctor, Mv: 627659405, Telf.:+34 926200049
representacionesgormaz@gmail.com

Murcia: Representaciones Gregorio Gonzalez, S.L

Gregorio, Mv: 649434479, Telf.:+34 968343740
rgregoriogonzalez@gmail.com

Canarias: Reinfer, SCP

Mario Ojeda, Mv: 629634495, Telf.:+34 928372314
marioojeda@reinfer.com

Cuenca, Albacete: Jose Antonio Simarro

Simarro, Mv: 610214720
representaciones@jasimarro.es

Además de nuestros Puntos de Venta de distribución Internacional;

ARGENTINA ▪ CARACAS ▪ CHILE ▪ COLOMBIA ▪ COSTA RICA ▪ ECUADOR ▪ EL SALVADOR
▪ GUATEMALA ▪ HONDURAS ▪ MEXICO ▪ PANAMA ▪ PERU ▪ REPÚBLICA DOMINICANA ▪
SANTO DOMINGO ▪ URUAGUAY ▪ VENEZUELA ▪ ABU DHABI ▪ ARABIA SAUDI ▪ CHIPRE ▪ MALTA
▪ ISRAEL ▪ RUMANIA ▪ SERBIA ▪ BELGICA ▪ HOLANDA ▪ FINLANDIA ▪ ALEMANIA ▪ INGLATERRA

CIERRES

HERRAJE CASTELLANO

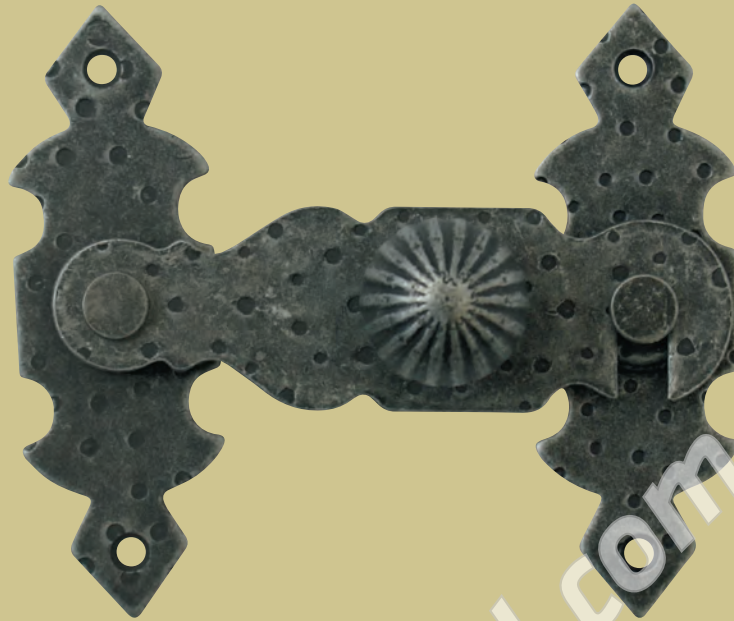

ALDABILLA

* 23

San Sebastián 1051

Botón 1052

085

085

085

CIERRES

Salomónico 640

Felipe II 660

085

085

PICAPORTES

Picaporte cierre presión salomónico

Picaporte de embutir reversible

* Picaporte estilo

* Picaporte ojo llave

* Picaporte trinquete solapo

086

087

086

087

087

Tabla de equivalencia; 1" pulgada = 25,4 milímetros

Para más modelos, visita nuestro catálogo de Fragua y Grannoble; www.emiliotortajadasl.com

ACABADOS EN STOCK: 1- NEGRO CASTELLANO / A- ANTICUARIO / P- PLATA VIEJA / 9- RUSTIK / 0- PULIDO

ACABADOS BAJO PEDIDO: 7- BLANCO / 2- LATÓN BRILLO / H- LATÓN MATE / 6- NIQUEL BRILLO / N- NIQUEL MATE / L- BRONCE INGLÉS / C- COBRE BRILLO / 3- BICROMATADO / 4- ZINCADO / * 8- ÓXIDO NATURAL / * M- FRAGUA

* Opción derecha o izquierda

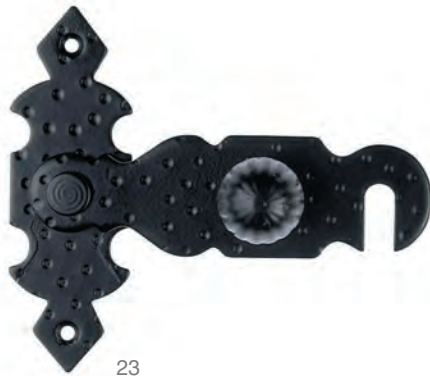

23

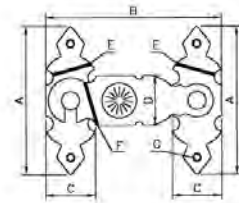

Ref.	A	B	C	D	E	F	G
23	90	106	30	30	1,5	3	∅3

Medidas en mm.

San Sebastián 1051

Botón 1052



1051; 1", 3/4", 1" 1/4"



1052; 1", 3/4", 1" 1/4", plana

Salomónico 640

Felipe II 660

CIERRES

* Opción derecha o izquierda

* Opción derecha o izquierda



640

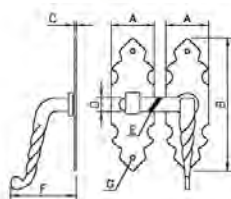

Ref.	A	B	C	D	E	F	G
640	30	90	2	10	3	43	∅3,5

Medidas en mm.



660

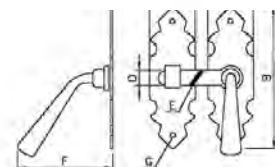

Ref.	A	B	C	D	E	F	G
660	30	90	2	10	3	60	∅3,5

Medidas en mm.

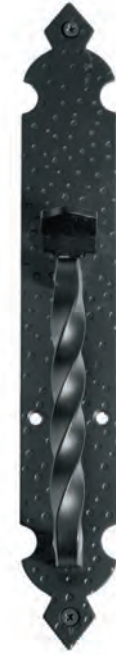

272 liso; 4"/5"/6"
273 mart.; 4"/5"/6"

Picaporte Estilo



271C

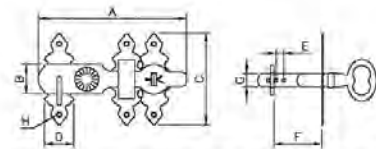

Ref.	A	B	C	D	E	F	G	H
271-C/4"	116	22	90	30	5	41	ø10	ø3
271-C/5"	143	24	90	30	5	67	ø10	ø3
271-C/6"	162	26	90	30	5	67	ø10	ø3

Medidas en mm.

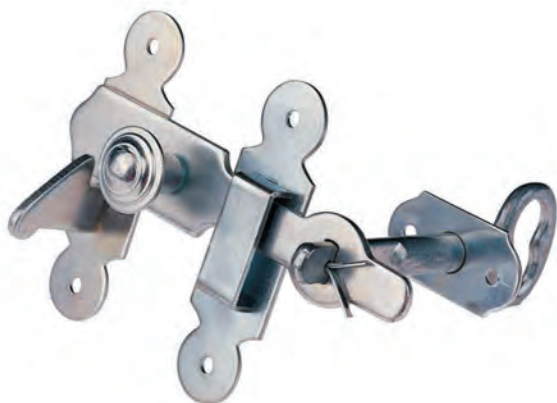

271

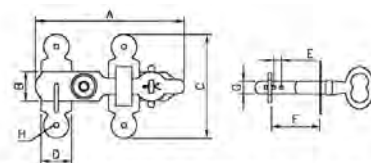

Ref.	A	B	C	D	E	F	G	H
271/4"	116	22	80	25	5	41	∅10	∅4
271/5"	143	24	80	25	5	67	∅10	∅4
271/6"	162	26	80	25	5	67	∅10	∅4

Medidas en mm.



578

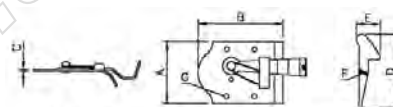

Ref.	A	B	C	D	E	F	G
578/2"	50	53	∅1,5	61	20	3	∅4
578/2"½	50	70	∅1,5	61	20	3	∅4

Medidas en mm.

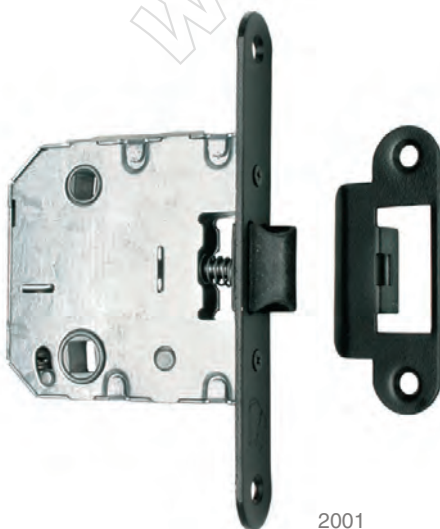

2001
Distancia entre agujeros 47 mm
Con condensa



2001
Canto cuadrado
Sin condensa

PASADORES

HERRAJE CASTELLANO



BERNAT

* Puerta calle 814

089

PASADOR DE TARJETA

* 331

089

PASADOR DE PLETINA

* 145, 166

090

PASADOR DE RABILLO

2302

* 5, 6, 7, 8, 2302

* 299, 300, 302, 303

090

090

090

PASADOR DE RABILLO GIRATORIO CON TORNILLO

* Pasador Giratorio base ancha

* Pasador Giratorio base estrecha

* Pasador Giratorio para soldar

091

091

091

Para más modelos, visita nuestro catálogo de Fragua y Grannoble; www.emiliotortajadasl.com

ACABADOS EN STOCK: 1- NEGRO CASTELLANO / A- ANTICUARIO / P- PLATA VIEJA / 9- RUSTIK / 0- PULIDO

ACABADOS BAJO PEDIDO: 7- BLANCO / 2- LATÓN BRILLO / H- LATÓN MATE / 6- NIQUEL BRILLO / N- NIQUEL MATE / L- BRONCE INGLÉS / C- COBRE BRILLO / 3- BICROMATADO / 4- ZINCADO / * 8- ÓXIDO NATURAL / * M- FRAGUA



381

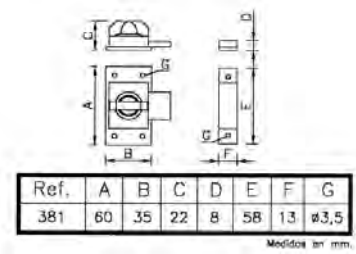

814

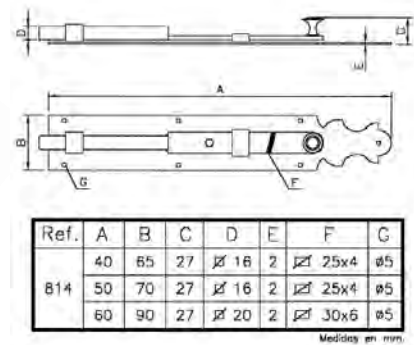



2302 Latón Brillo



5, 6, 7, 8



5 Anticuario

* Opción gafa alta. GA

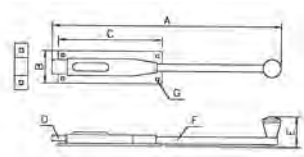

Ref.	A	B	C	D	E	F	G
2302	15-20-25 30-40-50	36	115	16x6	33	Ø8	Ø4

Medidas en mm.

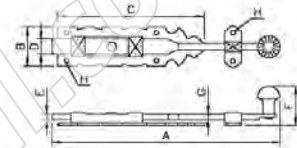

Ref.	A	B	C	D	E	F	G	H
5	15-20-25	35	135	14	5	31	Ø6	Ø4
6	30-40-50	40	150	16	6	34	Ø7	Ø4
7		45	165	18	8	37	Ø9	Ø4
8	60-70-80	60	190	20	10	38	Ø12	Ø4

Medidas en mm.

* Opción gafa alta. GA

* Opción gafa alta. GA



299, 300, 302, 303

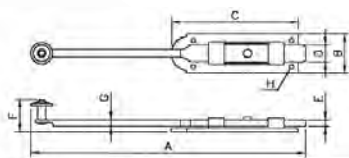

Ref.	A	B	C	D	E	F	G	H
299	15-20	35	106	14	5	29	Ø6	Ø3,5
300	25-30	36	116	16	6	30	Ø7	Ø3,5
302	40-50	44	150	18	8	32	Ø9	Ø4
303	60-70	60	190	20	10	36	Ø12	Ø5

Medidas en mm.



145, 166

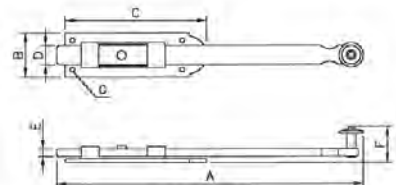

Ref.	A	B	C	D	E	F	G
145	15-20-25	35	106	14	5	28	Ø3,5
166	30-40-50	36	116	16	6	29	Ø3,5

Medidas en mm.



318, 318A, 318B

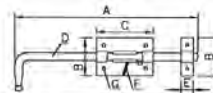

Ref.	A Medidas en mm.	B	C	D	E	F	G
318	20-25-30-40	57	85	∅12	18	2	∅5
	50-60-80-100						
318-B	20-25-30-40	60	100	∅14	24	2	∅6
	50-60-80						
	100-120-150						
318-A	25-30-40-50	70	120	∅16	28	2	∅6
	60-80-100						
	120-150-200						

Medidas en mm.



312, 314, 316

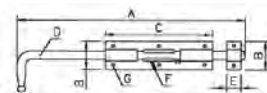

Ref.	A Medidas en mm.	B	C	D	E	F	G
312	25-30-40-50	40	150	∅12	20	1,5	∅5
	60-80-100						
314	25-30-40	42	150	∅14	22	2	∅5
	50-60-80						
	100-120-150						
316	25-30-40-50	45	150	∅16	24	2	∅5
	60-80-100						
	120-150-200						

Medidas en mm.



319, 320, 321

ESES RETENIDAS

HERRAJE CASTELLANO



ESES RETENIDAS

25, 25E, 25T

093

RETENIDAS

1001, 1002, 1003, 1004

(ACABADO SOLO EN 1- NEGRO CASTELLANO)

093

Cuenta una leyenda, que en la antigüedad las mujeres de los marineros mientras esperaban a que sus maridos volvieran de faenar, lo hacían con las ventanas cerradas. De ahí que en las retenidas cuando estaban bajadas se viera la cara de una mujer. Sin embargo, cuando llegaban los maridos a casa y abrían las ventanas, era cuando las retenidas estaban subidas manteniendo las ventanas abiertas y se veía la cara del hombre, que ya estaba en casa.

Para más modelos, visita nuestro catálogo de Fragua y Grannoble; www.emiliotortajadasl.com

ACABADOS EN STOCK: 1- NEGRO CASTELLANO / A- ANTICUARIO / P- PLATA VIEJA / 9- RUSTIK / 0- PULIDO

ACABADOS BAJO PEDIDO: 7- BLANCO / 2- LATÓN BRILLO / H- LATÓN MATE / 6- NIQUEL BRILLO / N- NIQUEL MATE / L- BRONCE INGLÉS / C- COBRE BRILLO / 3- BICROMATADO / 4- ZINCADO / 8- ÓXIDO NATURAL / M- FRAGUA



25

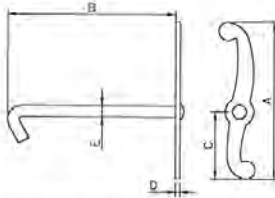

Ref.	A	B	C	D	E
25	135	145	58	4	10

Medidas en mm



25E

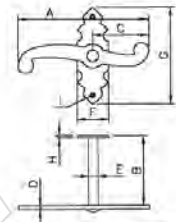

Ref.	A	B	C	D	E	F	G	H	I
25-E	135	72	58	4	10	32	100	2	84

Medidas en mm



25T

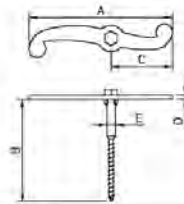

Ref.	A	B	C	D	E
25-T	135	100	58	4	8
	135	140	58	4	8

Medidas en mm

1001, 1002, 1003, 1004

RETENIDAS



1001



1002



1003



1004

FALLEBAS Y TERCIOS

HERRAJE CASTELLANO

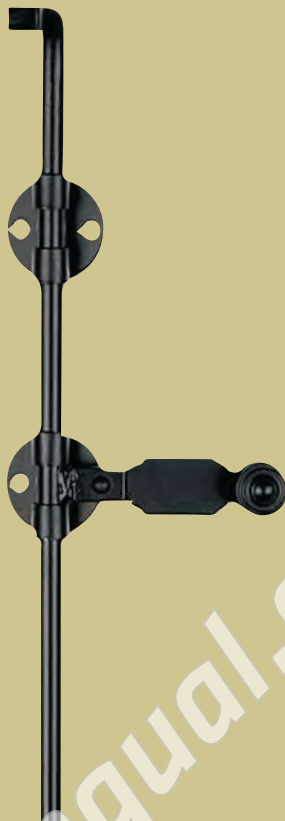

FALLEBAS

Corriente 34
Corriente 35
Castellana 36
Corriente 38

095
095
096
096

TERCIOS DE FALLEBA Y GANCHOS

840
Castellana 37
Corriente 39

097
097
097

Para más modelos, visita nuestro catálogo de Fragua y Grannoble; www.emiliotortajadasl.com

ACABADOS EN STOCK: 1- NEGRO CASTELLANO / 0- PULIDO

ACABADOS BAJO PEDIDO: A- ANTICUARIO / P- PLATA VIEJA / 9- RUSTIK / 7- BLANCO / 2- LATÓN BRILLO / H- LATÓN MATE / 6- NIQUEL BRILLO / N- NIQUEL MATE / L- BRONCE INGLÉS / C- COBRE BRILLO / 3- BICROMATADO / 4- ZINCADO / 8- ÓXIDO NATURAL / M- FRAGUA

Importante: Al solicitar la falleba se ruega dar a conocer los siguientes datos.

	Fig.1 (Abre dentro)	Fig.2 (Abre fuera)
Ø de	10 a 12 mm	
Largo total (A)	Altura hoja +1 marca	Altura hoja -5 mm
Alt. maneta (B)	Desde el extremo inferior	
Indicar	Apertura a Der. o Izq. En caso de llevar solapa, su medida	

Ref.	Ø	A	B	C	D	E	F	G
34	10	x	x	85	43	32	95	20
	12	x	x	100	45	32	115	25

Medidas en mm.

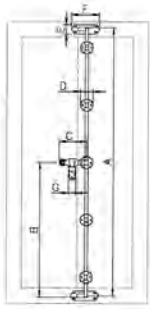

34
Cierre hacia dentro

34
Cierre hacia fuera

Corriente 35

Importante: Al solicitar la falleba se ruega dar a conocer los siguientes datos.

	Fig.1 (Abre dentro)	Fig.2 (Abre fuera)
Ø de	10 a 12 mm	
Largo total (A)	Altura hoja +1 marca	Altura hoja -5 mm
Alt. maneta (B)	Desde el extremo inferior	
Indicar	Apertura a Der. o Izq. En caso de llevar solapa, su medida	

Ref.	Ø	A	B	C	D	E	F	G
35	10	x	x	92	43	32	95	25
	12	x	x	92	45	32	115	25

Medidas en mm.

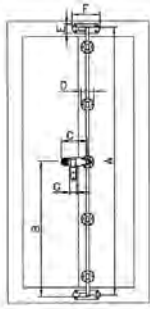

35
Cierre hacia dentro

35
Cierre hacia fuera



38
Cierre hacia dentro

38
Cierre hacia fuera

Importante: Al solicitar la falleba se ruega dar a conocer los siguientes datos.

	Fig.1 (Abre dentro)		Fig.2 (Abre fuera)	
	Ø de	10 o 12 mm		
Largo total (A)	Altura hoja +1 marca	Altura hoja -5 mm		
Alt. maneta (B)	Desde el extremo inferior			
Indicar	Apertura a Der. o Izq. En caso de llevar solapo, su medida			

Ref.	Ø	A	B	C	D	E	F	G
38	10	x	65	43	32	95	20	
	12	x	75	45	32	115	25	

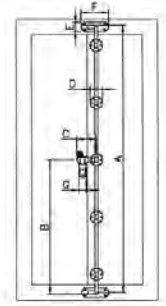

36
Cierre hacia dentro

36
Cierre hacia fuera

Importante: Al solicitar la falleba se ruega dar a conocer los siguientes datos.

	Fig.1 (Abre dentro)		Fig.2 (Abre fuera)	
	Ø de	10 o 12 mm		
Largo total (A)	Altura hoja +1 marca	Altura hoja -5 mm		
Alt. maneta (B)	Desde el extremo inferior			
Indicar	Apertura a Der. o Izq. En caso de llevar solapo, su medida			

Ref.	Ø	A	B	C	D	E
36	10	x	92	30	145	
	12	x	92	30	145	

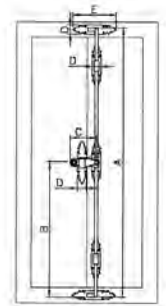



840

Castellana 37



37

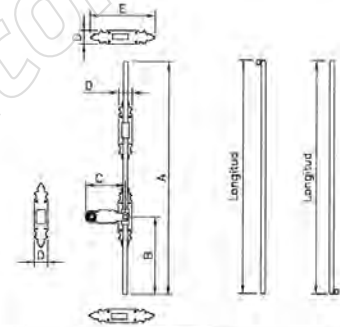

Ref.	∅	A	B	C	D	E
.37	10	500	170	92	30	146
	12	500	170	92	30	146
840	10 12	Longitud		250-500-750-1000		

Medidas en mm.

Corriente 39



39

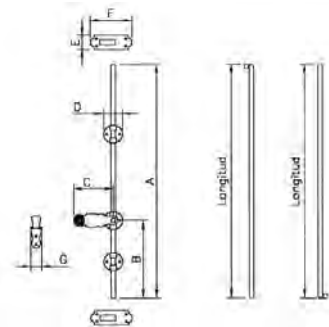

Ref.	∅	A	B	C	D	E	F	G
39	10	500	170	92	43	32	95	25
	12	500	170	92	45	32	115	25
840	10 12	Longitud		250-500-750-1000				

Medidas en mm.



MEDIAS FALLEBAS Y CREMONAS

HERRAJE CASTELLANO

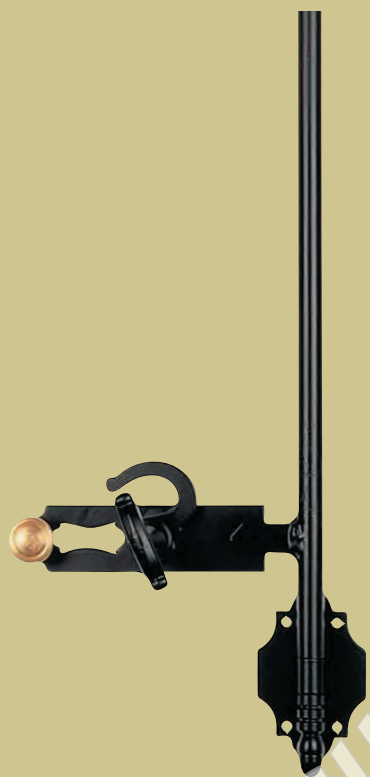

MEDIAS FALLEBAS

* 305

098

MEDIAS FALLEBAS POMO LATÓN

* 310

098

CREMONAS

1010, 1015

Varilla cremona

098

098

Para más modelos, visita nuestro catálogo de Fragua y Grannoble; www.emiliotortajadasl.com

ACABADOS EN STOCK: 1- NEGRO CASTELLANO / 0- PULIDO

ACABADOS BAJO PEDIDO: A- ANTICUARIO / P- PLATA VIEJA / 9- RUSTIK / 7- BLANCO / 2- LATÓN BRILLO / H- LATÓN MATE / 6- NIQUEL BRILLO / N- NIQUEL MATE / L- BRONCE INGLÉS / C- COBRE BRILLO / 3- BICROMATADO / 4- ZINCADO / * 8- ÓXIDO NATURAL / * M- FRAGUA

* Redondo 14, 16, ó 18 mm



Importante: Al solicitar la falleba se ruega dar a conocer los siguientes datos.

Indicar	Apertura Der. a Izq.	Ref.	Ø	A	B	C	D	E
En caso de llevar solapa, su medida		305	14	100	85	40	142	
		310	16	120	85	40	142	
		310	18	190	85	50	170	

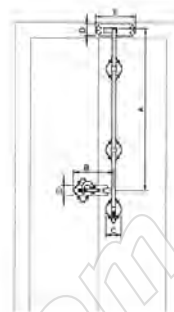

1010, 1015

305, 310

CREMONAS

* Varilla redonda 8 mm; Longitud (mm): 1000 / 1200 / 1500 / 2000 / 2500

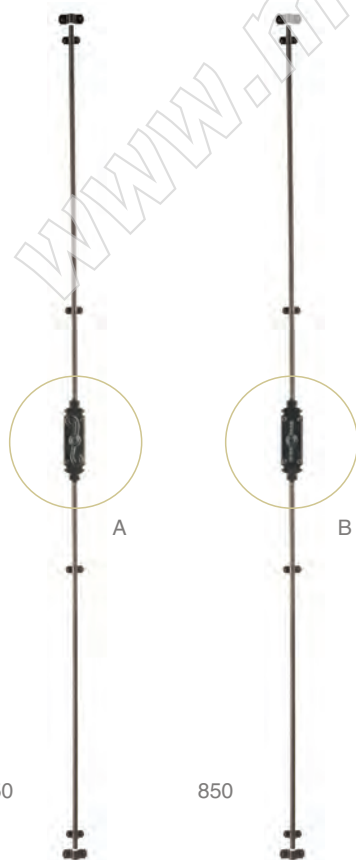

A, 1010



B, 1015



SOPORTE PASAMANOS

HERRAJE CASTELLANO



SOPORTE PASAMANOS

831
832
833

102
102
102

SOPORTE PASAMANOS REGULABLE

834

102

Para más modelos, visita nuestro catálogo de Fragua y Grannoble; www.emiliotortajadasl.com

ACABADOS EN STOCK: 1- NEGRO CASTELLANO / A- ANTICUARIO / P- PLATA VIEJA / 9- RUSTIK / 0- PULIDO

ACABADOS BAJO PEDIDO: 7- BLANCO / 2- LATÓN BRILLO / H- LATÓN MATE / 6- NIQUEL BRILLO / N- NIQUEL MATE / L- BRONCE INGLÉS / C- COBRE BRILLO / 3- BICROMATADO / 4- ZINCADO / 8- ÓXIDO NATURAL / M- FRAGUA

831



831

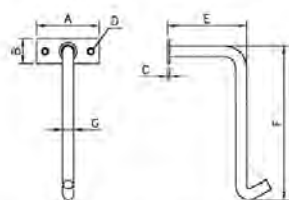

Ref.	A	B	C	D	E	F	G
831	56	22	2	∅4	70	130	∅10

Medidas en mm.

832

SOPORTE PASAMANOS



832

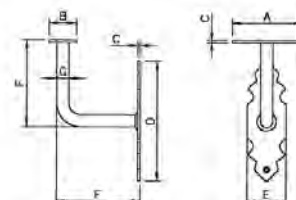

Ref.	A	B	C	D	E	F	G	H
832	56	22	2	100	32	70	∅10	∅4

Medidas en mm.

833



833

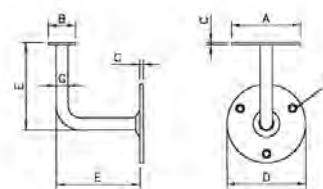

Ref.	A	B	C	D	E	F	G
833	56	22	2	∅65	70	∅5	∅10

Medidas en mm.

834

SOPORTE PASAMANOS REGULABLE

* Redondo 8 (73-105 mm)



834



Fabricando en España desde 1886

ESCUADRAS

HERRAJE CASTELLANO



ESCUADRAS ÁNGULO

72
73
466

103
103
103

ESCUADRAS PLANAS

24CE
70, 70P
465

104
104
104

Para más modelos, visita nuestro catálogo de Fragua y Grannoble; www.emiliotortajadasl.com

ACABADOS EN STOCK: 1- NEGRO CASTELLANO / A- ANTICUARIO / P- PLATA VIEJA / 9- RUSTIK / 0- PULIDO

ACABADOS BAJO PEDIDO: 7- BLANCO / 2- LATÓN BRILLO / H- LATÓN MATE / 6- NIQUEL BRILLO / N- NIQUEL MATE / L- BRONCE INGLÉS / C- COBRE BRILLO / 3- BICROMATADO / 4- ZINCADO / 8- ÓXIDO NATURAL / M- FRAGUA



72

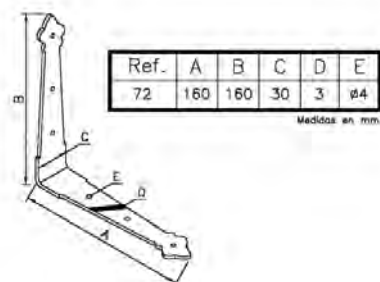

100x75 mm
150x115 mm
200x150 mm
250x200 mm



73



73



466

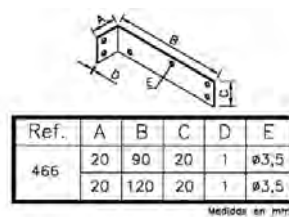

200x200 mm
250x250 mm
300x300 mm
400x400 mm
500x500 mm



24CE

70, 70P



70P Plata

70, 70P

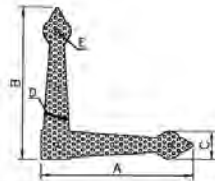

Ref.	A	B	C	D	E
70	160	160	30	2	∅4
70-P	130	130	25	2	∅4

Medidas en mm.

465

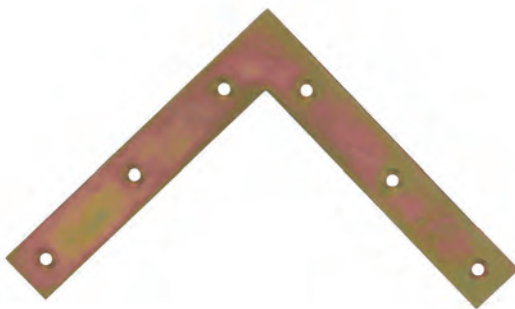

465

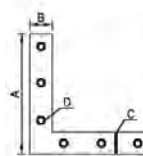

Ref.	A	B	C	D
465-3"	70	17	1	∅4,5
465-4"	91	17	1,5	∅4,5
465-5"	114	20	1,5	∅4,5
465-6"	137	22	1,5	∅4,5
465-7"	160	25	2	∅4,5
465-8"	184	25	3	∅4,5

Medidas en mm.



www.mengual.com

NUMEROS, LETRAS, CARTELES

HERRAJE CASTELLANO



NUMEROS

Tamaño 64 mm
Tamaño 72 mm

107
107

LETRAS

Tamaño 64 mm
Tamaño 72 mm

107
107

CARTELES

Señalética (WC, salida...)

107

Para más modelos, visita nuestro catálogo de Fragua y Grannoble; www.emiliotortajadasl.com

ACABADOS EN STOCK: 1- NEGRO CASTELLANO / A- ANTICUARIO / P- PLATA VIEJA / 9- RUSTIK / 0- PULIDO

ACABADOS BAJO PEDIDO: 7- BLANCO / 2- LATÓN BRILLO / H- LATÓN MATE / 6- NIQUEL BRILLO / N- NIQUEL MATE / L- BRONCE INGLÉS / C- COBRE BRILLO / 3- BICROMATADO / 4- ZINCADO / 8- ÓXIDO NATURAL / M- FRAGUA

Tamaño 64 mm
Tamaño 72 mm

15 15

Tamaño 64 mm
Tamaño 72 mm

A B C D E F
Ñ O P Q R S



TORNILLOS

HERRAJE CASTELLANO



TORNILLOS

72



Ref.	Medidas	Cabeza	Ref.	Medidas	Cabeza
49	14 x 20	Alomada	53	19 x 20	G.Sebo
51	18 x 15	Alomada	56	19 x 25	G.Sebo
54	19 x 20	Alomada	59	19 x 20	Plana
61	19 x 25	Alomada	57	19 x 25	Plana
52	18 x 15	G.Sebo	58	20 x 30	Plana

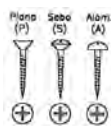

Ref.	Medidas	Ref.	Medidas
49-A	14 x 20	53-S	19 x 20
51-A	18 x 15	56-S	19 x 25
54-A	19 x 20	59-P	19 x 20
61-A	19 x 25	57-P	19 x 25
52-S	18 x 15	58-P	20 x 30

Emilio Tortajada, S.L.

Cerrajería Mecánica - Herraje Castellano

Desde 1886

100% HECHO EN ESPAÑA

FRAGUA Y FORJA ARTESANAL, piezas exclusivas en *Emilio Tortajada, S.L.*

*Fragua artesanal, hecha a mano según una larga tradición heredada de los mejores artesanos.
Piezas forjadas con diseños únicos y exclusivos, que personalizan y distinguen cada rincón de la casa.*



PERCHAS

HERRAJE CASTELLANO



PERCHAS

901	111
902, 903	111
* 941	112
* 942, 943	112
* 981	112
* P1	111
* P2	111

Para más modelos, visita nuestro catálogo de Fragua y Grannoble; www.emiliotortajadasl.com

ACABADOS EN STOCK: 1- NEGRO CASTELLANO / A- ANTICUARIO / P- PLATA VIEJA / 9- RUSTIK / 0- PULIDO

ACABADOS BAJO PEDIDO: 7- BLANCO / 2- LATÓN BRILLO / H- LATÓN MATE / 6- NIQUEL BRILLO / N- NIQUEL MATE / L- BRONCE INGLÉS / C- COBRE BRILLO / 3- BICROMATADO / 4- ZINCADO / * 8- ÓXIDO NATURAL / * M- FRAGUA



901

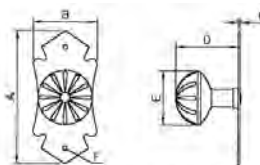

Ref.	A	B	C	D	E	F
901	134	65	2	66	55	Ø4,5

Medidas en mm.

902, 903



902

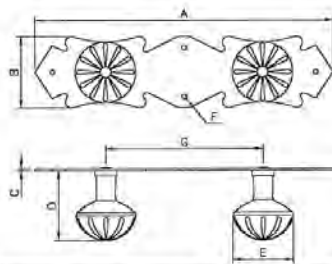

Ref.	A	B	C	D	E	F	G
902	272	65	2	66	55	Ø4,5	138
903	410	65	2	66	55	Ø4,5	138

Medidas en mm.



903

P1



P1

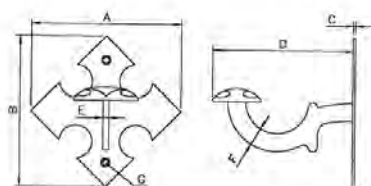

Ref.	A	B	C	D	E	F	G
P-1	100	100	1,5	95	4	12	Ø4

Medidas en mm.

P2



P2

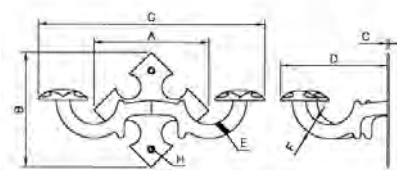

Ref.	A	B	C	D	E	F	G	H
P-2	100	100	1,5	75	4	12	170	Ø4

Medidas en mm.



941

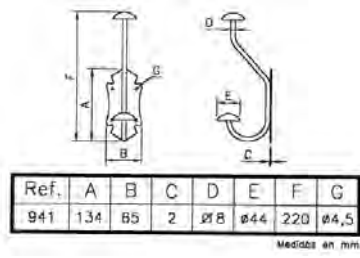

942

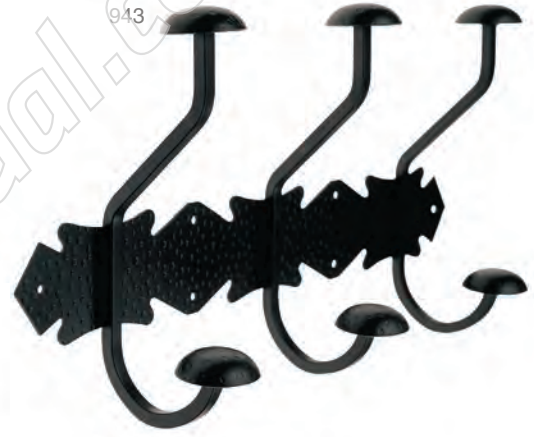

943

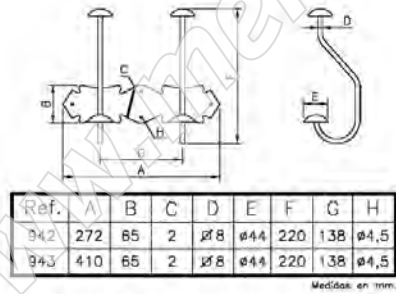

981

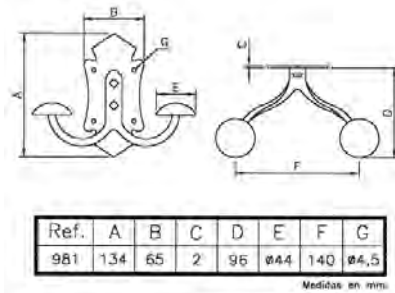

Emilio Tortajada, S.L.

Cerrajería Mecánica - Herraje Castellano

Desde 1886

100% HECHO EN ESPAÑA



MEDIO AMBIENTE. RSC

Nuestras instalaciones están equipadas con maquinaria de alta tecnología, tanto en los procesos de fabricación como en los de depuración (tratamiento de aguas y residuos sólidos), acentuando nuestro compromiso con la calidad y con el medio ambiente.

www.emiliotortajadasl.com



Emilio Tortajada, S.L.

Cerrajería Mecánica - Herraje Castellano

Fabricando en España desde 1886

www.metaligual.com



C/ TURIA, 4 - POLÍG. IND. DEL MEDITERRÁNEO
46550 ALBUIXECH (VALENCIA)
Tel. 96 140 02 30 - Fax 96 141 73 43
contacto@emiliotortajadasl.com
www.emiliotortajadasl.com