

9 CERRAJERÍA

2022



Pág. 696

Picaportes



Pág. 705

Muletillas
puerta corredera



Pág. 709

Cuadradillos
y reductores

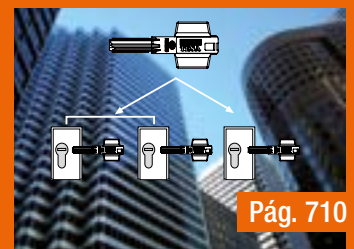

Pág. 710

Combinaciones
y amaestramientos



Pág. 712

Cilindros leva estándar

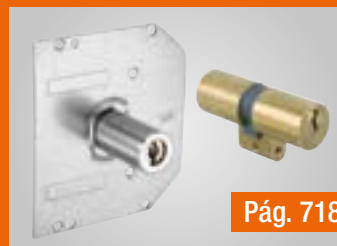

Pág. 718

Cilindros levas
especiales



Pág. 721

Bocallaves seguridad



Pág. 724

Control de accesos



Pág. 732

Cierres eléctricos



Pág. 740

Cerraduras
sobrepuestas



Pág. 750

Cerraduras embutidas



Pág. 762

Cerraduras largas
seguridad

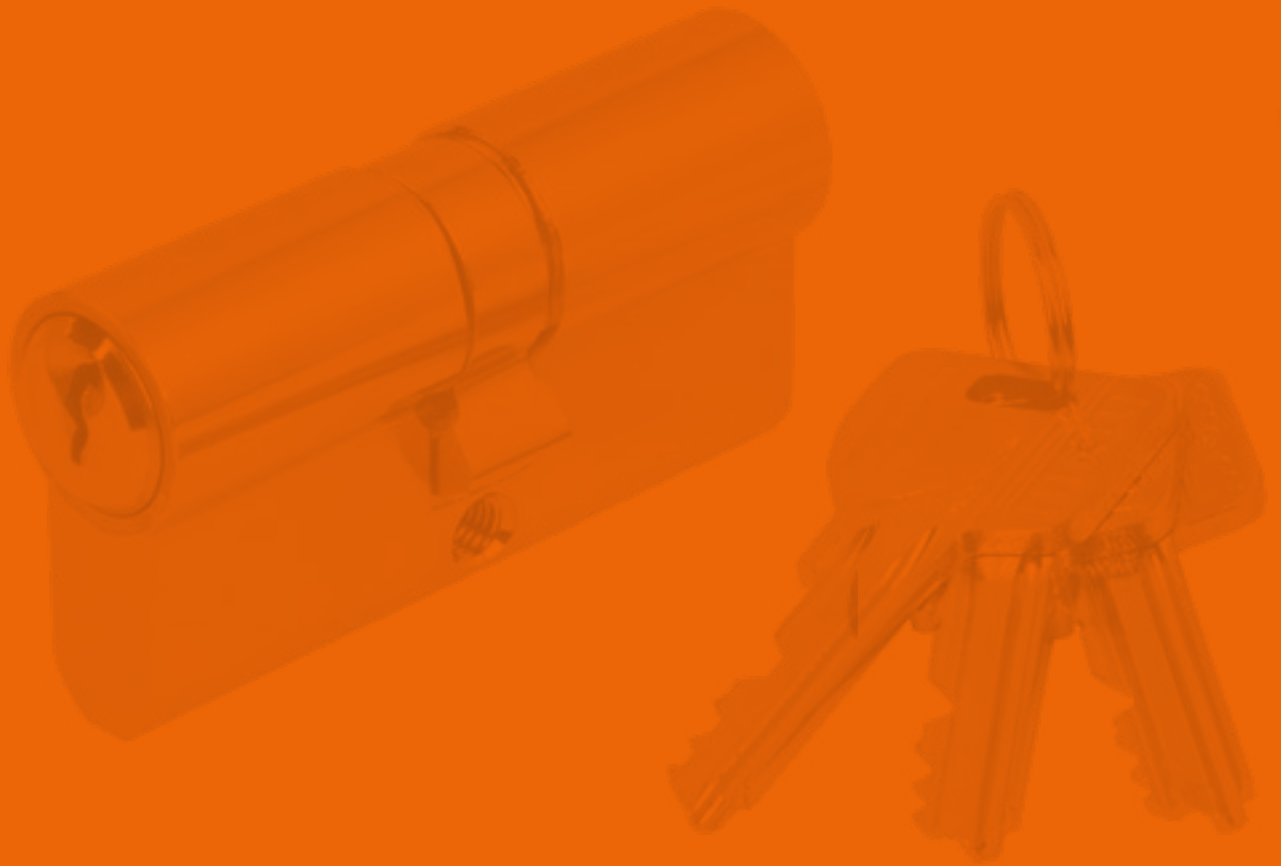

Pág. 760

Cerraduras portería



Pág. 774

Puertas acorazadas



Pág. 776

Cerraduras carpintería metálica



Pág. 782

Candados y cerrojos



Pág. 787

Cajas fuertes



Pág. 790

Cierrapuertas



Pág. 804

Antipánicos



Pág. 811

Cremonas, fallebas y españoletas



Pág. 817

Ventanas oscilobatientes



Pág. 818

Cerraduras para mueble



Pág. 821

Fallebas mueble y cerraduras cajón

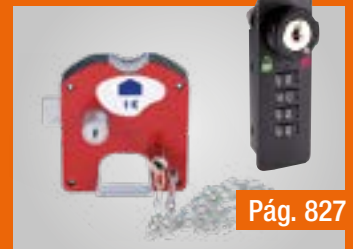

Pág. 827

Cerraduras para taquilla

Golpe y llave portería **ARCU 322** - Gorjas
Acero

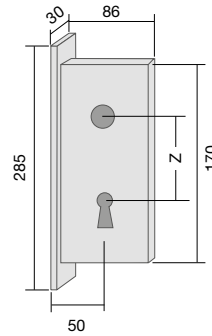

En Z se indican 2 medidas, la primera es la que va en la parte interior, y la segunda la que va al exterior. Si la puerta abre al revés, las medidas serán a la inversa.

Esta cerradura es un modelo muy indicado para porterías, porque al tener un pivote cerradero menos permite acoplarse al cierre eléctrico.

		Código	
Z	Mano	Latonado	
51/102'5	Derecha	1/6	34.0156.1
51/102'5	Izquierda	1/6	34.0157.2

Solo golpe portería **ARCU 304** - Gorjas
Acero

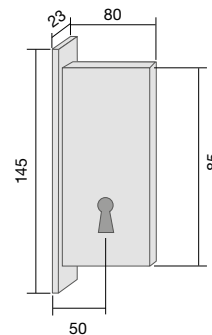

		Código	
Mano	Cromo Brillo		
Derecha	1/6	34.0150.2	
Izquierda	1/6	34.0151.3	

Solo golpe portería **ARCU 304** Golpe al revés gorjas
Acero

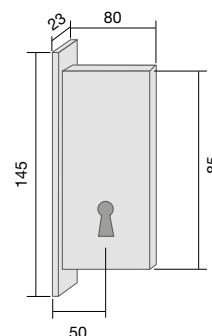

Instalación en puertas con apertura hacia el exterior.

		Código	
Mano	Cromo Brillo		
Derecha	1/6	34.1446.3	
Izquierda	1/6	34.1447.4	

Solo golpe portería **TESA 2219**
Acero

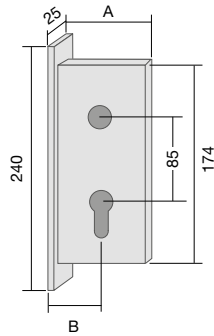

Este modelo se suministra con cilindro 5200 de 40 mm. (leva r13,2).

		Código	
A	B	📦	Acero Inox
33	20	1/20	🔒 34.0565.4
38	25	1/20	🔒 34.2669.1
43	30	1/20	🔒 34.2670.2
48	35	1/20	🔒 34.2671.3

Golpe extensible **TESA 3520**
Acero

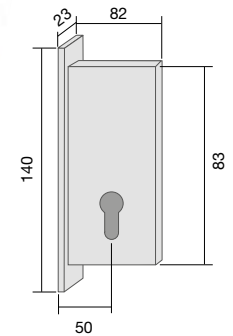

Este modelo se suministra con cilindro 5520.

		Código	
📦		Latón Mate	Cromo Mate
1/20		34.0396.3	34.0409.2

Golpe extensible **MCM 1561**
Acero

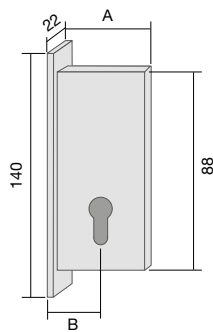

Este modelo se suministra con cilindro Pomo/Bombillo

		Código	
A	B	📦	Latón Mate
80	50	1/12	34.0620.3
90	60	1/12	34.1122.1
100	70	1/12	34.1123.2

Golpe extensible **MCM 1562**
Acero

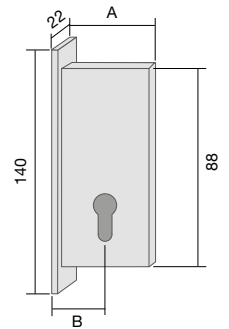

Este modelo se suministra con cilindro Pomo/Pomo

		Código	
A	B	📦	Latón Mate
100	70	1/12	🔒 34.1126.5

TESA 2200

Acero

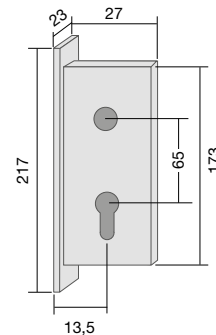

Este modelo se suministra con cilindro 5200 de 60 mm. (leva r13,2).

Código

	Zincado
1/20	34.0557.3

TESA 2210 - Deslizante

Acero

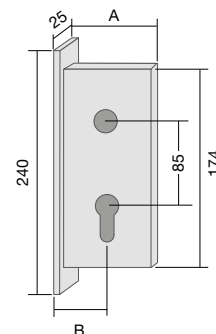

Este modelo se suministra con cilindro 5200 de 60 mm. (leva r13,2).

Código

A	B		Acero Inox
33	20	1/20	34.0560.6
38	25	1/20	34.2650.3

TESA 2210/3AI - Basculante

Acero

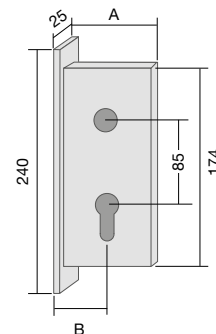

Este modelo se suministra con cilindro 5200 de 60 mm. (leva r13,2).

Código

A	B		Acero Inox
33	20	1/20	34.2303.6
38	25	1/20	34.2651.4
43	30	1/20	34.2652.5
48	35	1/20	34.2653.6

TESA 2230L - 3 Puntos frente "U"
Acero



TESA 2230P - 3 Puntos frente plano
Acero

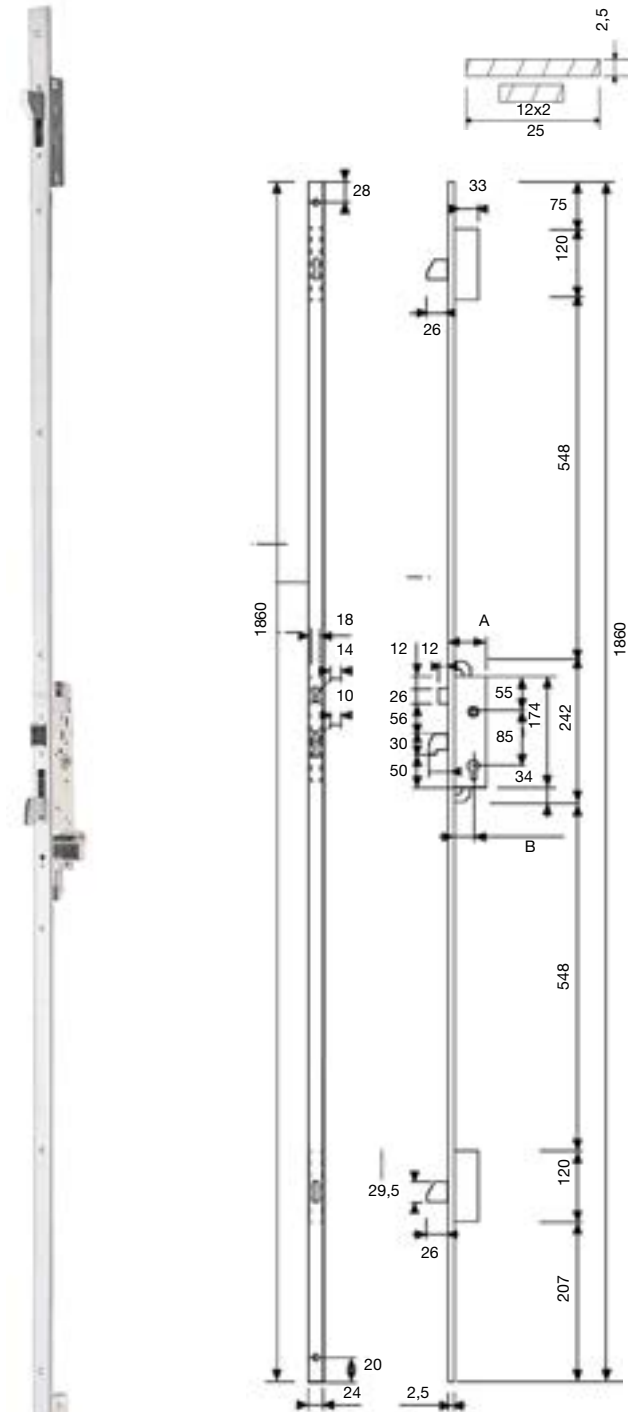
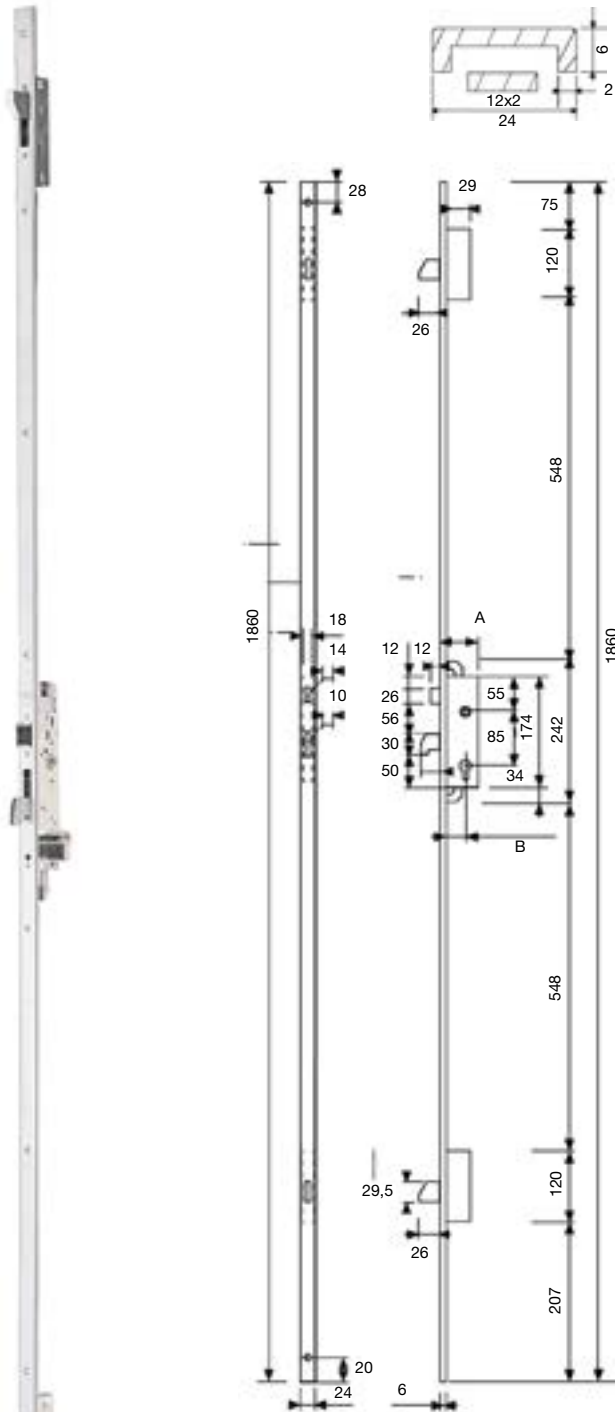

Ver también...
9.02 Bocallaves de seguridad
Página 721

Ver también...
9.02 Bocallaves de seguridad
Página 721

Este modelo se suministra con cilindro 5200 de 60 mm. (leva r13,2).

Código			
A	B		Acero Inox
34	21	1/4	34.2675.0
39	26	1/4	34.2676.1
44	31	1/4	34.2677.2

Este modelo se suministra con cilindro 5200 de 60 mm. (leva r13,2).

Código			
A	B		Acero Inox
34	25	1/4	34.2678.3
39	30	1/4	34.2679.4
44	35	1/4	34.2680.5

TESA 2230 - 3 Puntos varillas

Acero

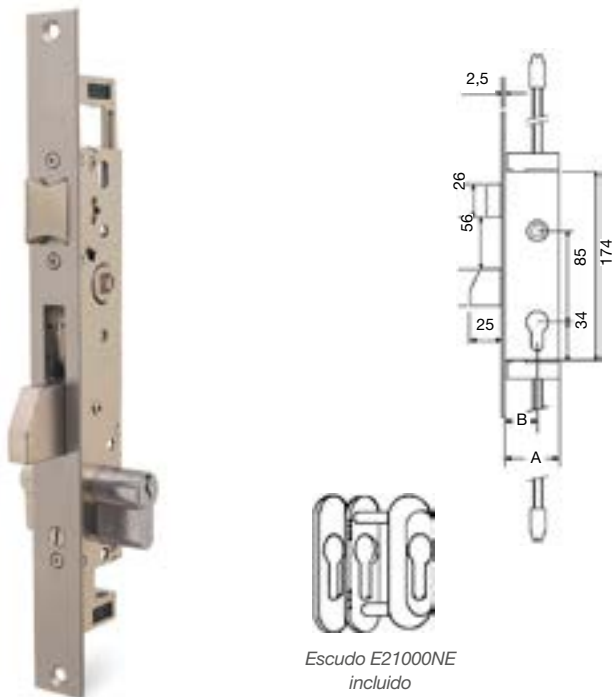

Este modelo se suministra con cilindro 5200 de 60 mm. (leva r13,2).

Código			
A	B		Acero Inox
33	20	1/20	34.0569.1
38	25	1/20	34.2672.4
43	30	1/20	34.2673.5
48	35	1/20	34.2674.6

TESA 2240

Acero

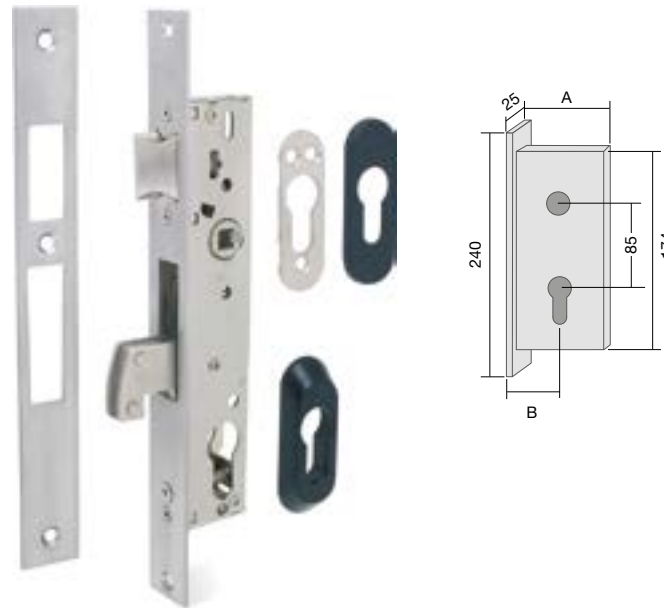

Este modelo se suministra con cilindro 5200 de 60 mm. (leva r13,2).

Código			
A	B		Acero Inox
33	20	1/20	34.0570.2
38	25	1/20	34.2654.0
43	30	1/20	34.2655.1
48	35	1/20	34.2656.2

TESA 2216

Acero

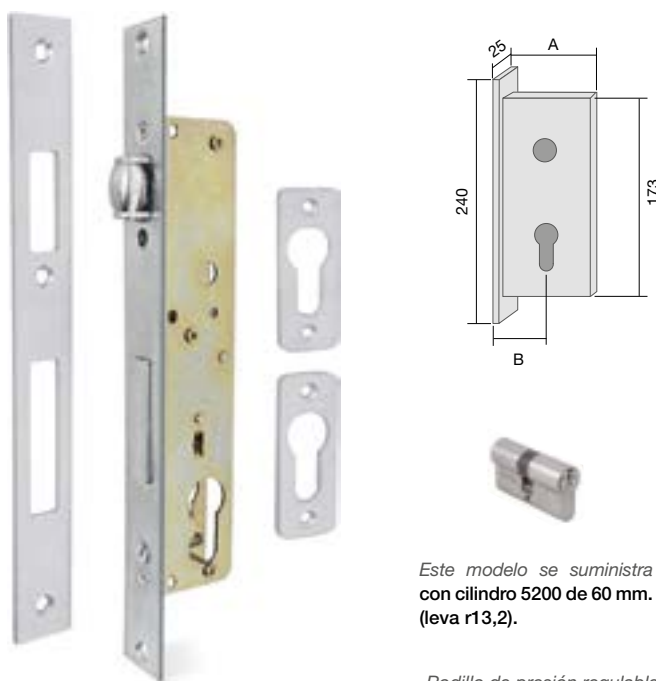

Este modelo se suministra con cilindro 5200 de 60 mm. (leva r13,2).

Rodillo de presión regulable

Código			
A	B		Acero Inox
33	20	1/20	34.0563.2
38	25	1/20	34.2657.3
43	30	1/20	34.2658.4

TESA 2246

Acero

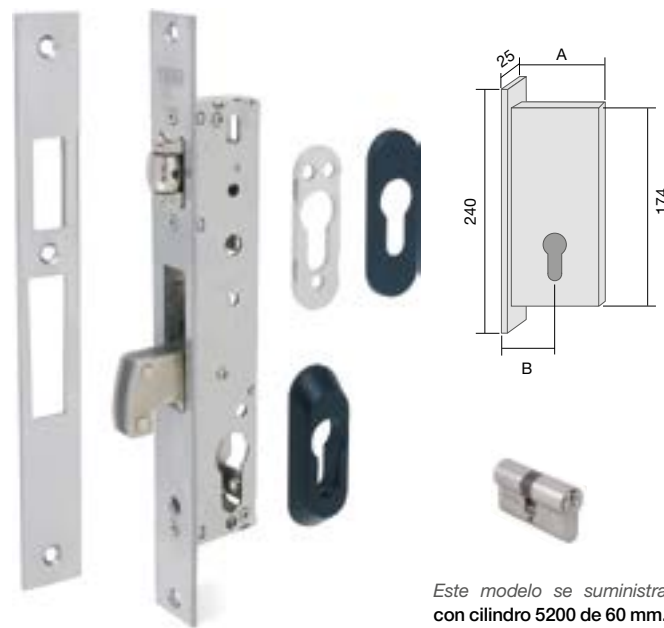

Este modelo se suministra con cilindro 5200 de 60 mm. (leva r13,2).

Rodillo de presión regulable

Código			
A	B		Zincado
33	20	1/20	34.0572.4
38	25	1/20	34.2666.5
43	30	1/20	34.2667.6

MCM 1552 - Picaporte rodillo **sin** cerradero
Acero

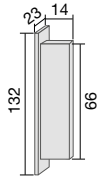

Rodillo de presión regulable

Código	
	Cromo Brillo
1/30	34.0619.2

TESA 2218 - Picaporte rodillo con cerradero
Acero

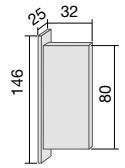

Rodillo de presión regulable

Código	
	Acero Inox
1	34.3104.2

SOLO GANCHO

PICAPORTES DE GOLPE

TESA 2215
Acero

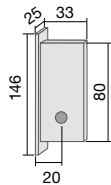

Código	
	Acero Inox
1	34.0562.1

TESA 2241
Acero

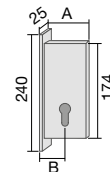

Este modelo se suministra con cilindro 5200 de 60 mm. (leva r13,2).

Código			
A	B		Acero Inox
33	20	1/20	34.0571.3
38	25	1/20	P 34.2660.6
43	30	1/20	P 34.2661.0
48	35	1/20	34.2662.1

SOLO LLAVE

TESA 2201
Acero

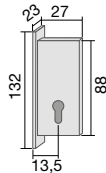

Este modelo se suministra con cilindro 5200 de 60 mm. (leva r13,2).

Código	
	Zincado
1	P 34.0558.4

TESA 2211 - Deslizante
Acero

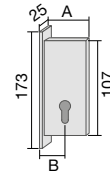

Este modelo se suministra con cilindro 5200 de 60 mm. (leva r13,2).

Código			
A	B		Acero Inox
33	20	1	34.0561.0
38	25	1	34.2663.2

TESA 2211/3AI - Basculante
Acero

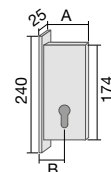

Este modelo se suministra con cilindro 5200 de 60 mm. (leva r13,2).

Código			
A	B		Acero Inox
33	20	1/20	P 34.2688.6
38	25	1/20	P 34.2689.0
43	30	1/20	P 34.2664.3