

7 ARMARIO

2022



Pág. 560

Estructuras decorativas



Pág. 565

Lamas y perfilera multifunción



Pág. 566

Interiores colección Moka



Pág. 569

Cestas extraíbles



Pág. 570

Faldas y pantaloneros



Pág. 572

Zapateros



Pág. 575

Espejos, colgadores y corbateros



Pág. 577

Barras de armario con y sin iluminación Led



Pág. 582

Colgadores basculantes



Pág. 584

Guías embutidas

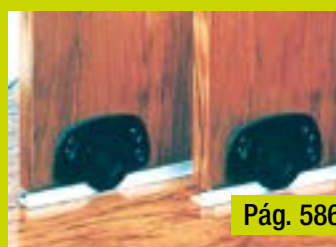

Pág. 586

Guías sobrepuestas



Pág. 588

Guías y herrajes ocultos

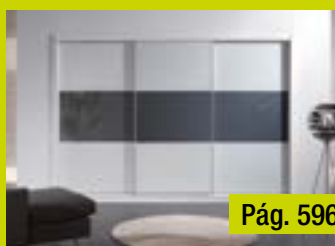

Pág. 596

Perfiles para armarios (Atlántico)



Pág. 606

Guías planas o coplanares



Pág. 611

Correderas verticales



Pág. 612

Sistema hojas batientes ocultas retráctiles



Pág. 616

Guías y herrajes para puertas plegables



Pág. 618

Guías y herrajes para puertas suspendidas



Pág. 619

Felpas y enderezadores

TAKI - Estructura decorativa
Aluminio

ARMARIO

EQUIPAMIENTO PARA ARMARIO



TAKI es un sistema de aluminio extremadamente versátil que le permite crear un amplio rango de soluciones de muebles. Su estética esencial y su fácil instalación lo hacen que sea adecuado para cada espacio vivo.

Características:

- Sistema modular de montaje rápido.
- Apto para estantes de 4 a 19 mm. de espesor.
- Bloqueo de seguridad para estantes de vidrio.

Contenido del kit:

- 1- Perfiles con pestaña para estante: 4 uds.
- 2- Ángulo 3 vías derecho: 4 uds.
- 3- Perfiles sin pestaña: 8 uds.
- 4- Ángulo 3 vías izquierdo: 4 uds.

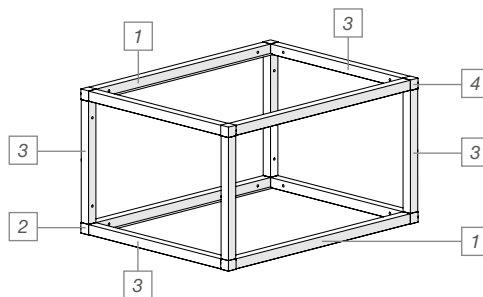

Vídeo e instrucciones



						Código
Descripción	Ancho	Alto	Fondo			Negro Mate
Kit estructura	450	360	330	1/20		30.0521.5
Kit estructura	600	360	330	1/20		30.0522.6
Kit estructura	900	360	330	1/20		30.0523.0

TAKI - Estructura decorativa

Aluminio

Perfil 2 m.
Aluminio

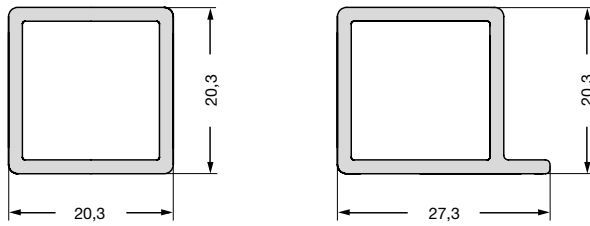

El perfil con pestaña es para dar apoyo a un estante de 19 mm. Para otros espesores, necesitará solicitar los kits de regreso Cód. 30.0525.2

Para estante de vidrio de 4 mm. se requiere el kit de soporte cristal Cód. 30.0524.1

Descripción	Largo	Código
Barra sin pestaña	2000 mm.	30.0526.3
Barra con pestaña	2000 mm.	30.0527.4

Kit regreso para estante

ABS

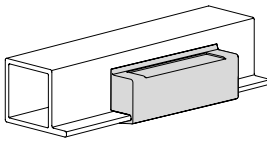

Juego de 4 compensadores para 1 estante de diferentes gruesos.

Espesores:
8 - 10 - 12 - 14 - 16

Código
1/100 Negro Mate 30.0525.2

Kit 4 soportes para vidrio de 4 mm.

ABS

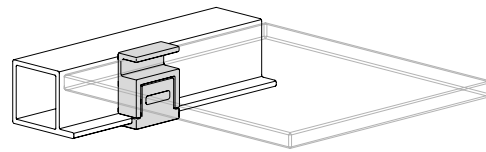

Código
1/100 Negro Mate 30.0524.1

Tornillo para ángulos

Aluminio

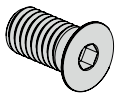

Allen

Código
1/500 Negro Mate 30.0534.4

Ángulo universal 5 vías (1 unidad)

Zamak

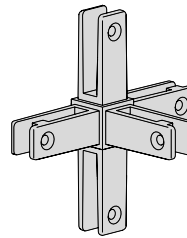

Código
1/50 Negro Mate 30.0532.2

Kit de 2 ángulos 4 vías (derecho + izquierdo)

Zamak

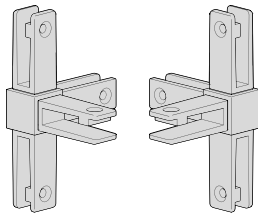

Código
1/50 Negro Mate 30.0536.6

Kit de 2 ángulos 3 vías (derecho + izquierdo)

Zamak

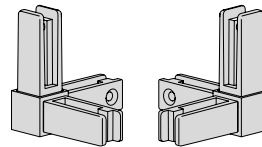

Código
1/100 Negro Mate 30.0537.0

Escuadra de fijación pared

Aluminio

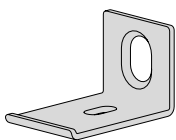

Código
1/200 Negro Mate 30.0533.3

Plantilla de perforación

ABS

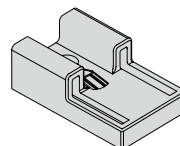

Permite marcar el perfil para perforar a la medida precisa.

Código
1/200 Negro Mate 30.0535.5

PANELSYSTEM - Perfilera oculta modular

Aluminio

ARMARIO

EQUIPAMIENTO PARA ARMARIO



PANELSYSTEM permite crear espacios de gran amplitud visual pudiendo exponer los productos de una manera atractiva y sencilla.

Conjunto de paneles y baldas soportados mediante perfiles ocultos de aluminio atornillados a la pared.

Su diseño permite regular las baldas a la altura deseada gracias a la cremallera que incorporan los perfiles. Las baldas a utilizar son de 30 mm.

El grosor del panel trasero debe ser de 10 mm. si queremos tener la profundidad de estante de 543 / 350 mm. Si se aumenta el espesor de la trasera se reduce la profundidad del estante.

Para instalaciones en paredes de vidrio solicite la perfilera para vitrinas MINIM 8.

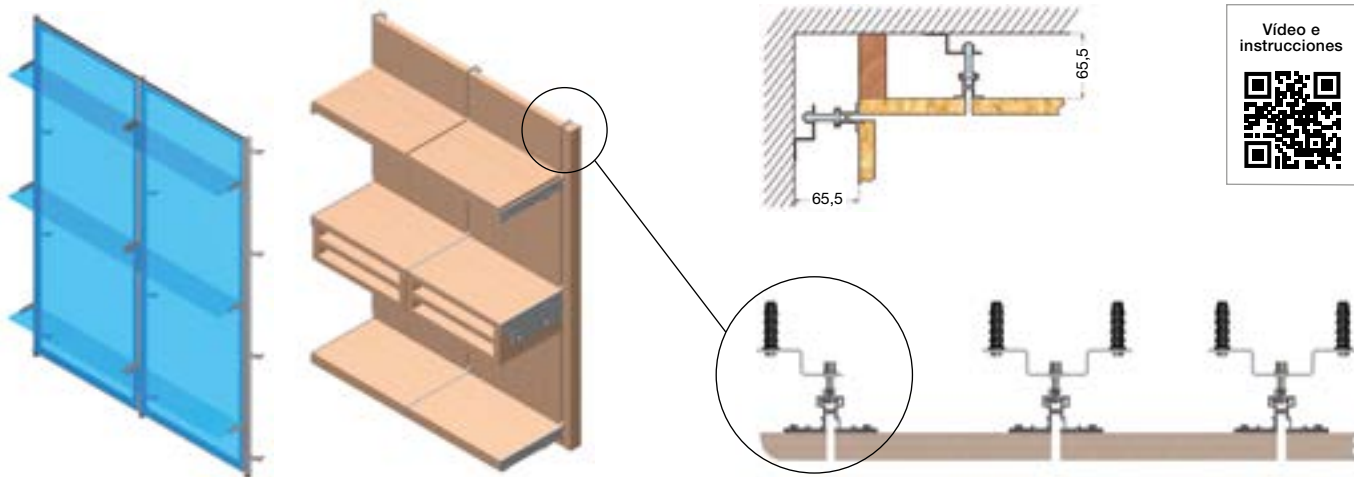

Vídeo e instrucciones



Perfil básico V3 con mecanizado bocallave
Aluminio

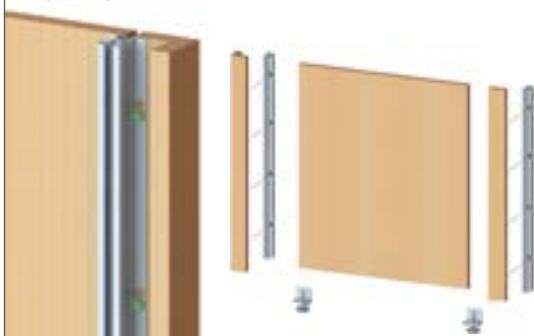

El perfil V3 incluye los anclajes y tornillería.



Pie izquierdo



Pie derecho

Descripción	Código
Perfil V3 de 2,8 m.	Aluminio 30.0004.4
Pie regulable izquierdo	30.0005.5
Pie regulable derecho	30.0006.6

PANELSYSTEM - Perfilera oculta modular

Aluminio

Perfil básico con regulación opcional

Aluminio

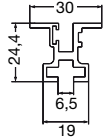

Incluye cepillo de polipelo decorativo.

Permite 2 cartelas en una misma regata.

Código		
Largo	Aluminio	
2,8 m.	1	30.0346.5

Pie con regulación

Aluminio



Código		
Aluminio		
1	30.0349.1	

Clip para panelado

Nylon



Código		
Aluminio		
1	30.0350.2	

Soporte fijación pared regulación

Aluminio

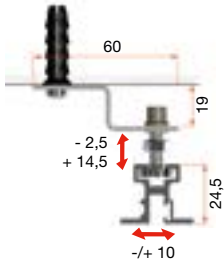

Simple

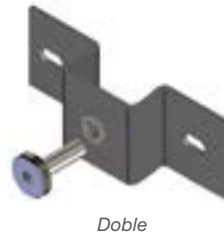
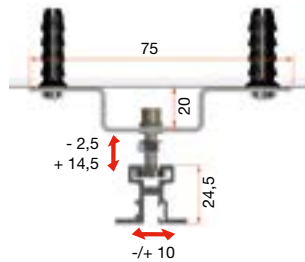

Doble

Regulación lateral y en profundidad

Código		
Tipo	Aluminio	
Simple	1	30.0347.6
Doble	1	30.0348.0

Juego de cartelas

Aluminio



Cartela baja

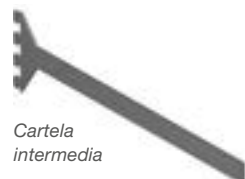

Cartela intermedia



Cartela para cajón



Cartela para zapatero

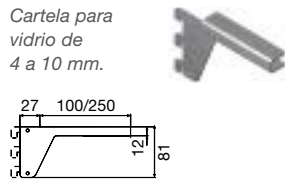

Cartela para vidrio de 4 a 10 mm.

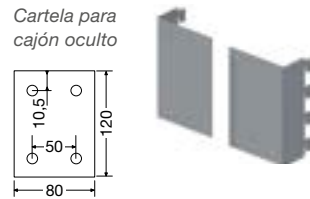

Cartela para cajón oculto

Para estante continuo se requiere un juego de cartelas por cada partición (distancia entre perfil y perfil). El perfil soporta 2 cartelas en la misma regata.

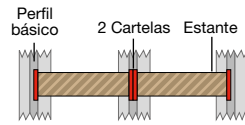

Perfil básico

2 Cartelas Estante

IMPORTANTE
Los códigos hacen referencia a un juego de 2 cartelas.

Descripción	Código		
	Aluminio	Moka	
Jgo. cartela baja	1	30.0352.4	30.0007.7
Jgo. cartela intermedia 350 mm	1	30.0355.0	30.0008.8
Jgo. cartela intermedia 543 mm	1	30.0353.5	30.0009.9
Jgo. cartela para cajón 543 mm	1	30.0354.6	30.0011.0
Jgo. cartela para vidrio 100 mm	1	30.0351.3	
Jgo. cartela para vidrio 250 mm	1	30.0012.1	
Jgo. cartela zapatero 543 mm	1	30.0013.2	30.0014.3
Jgo. cartela cajonero oculto	1	30.0015.4	

MALETERO - Juego de guías para embutir

Aluminio

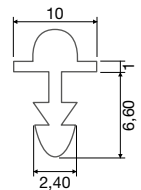

Permite crear estantes aptos para colocar maletas protegiendo así la madera. Ideal para hoteles o proyectos contract.

Código		
Descripción	Aluminio	
Jgo. de 3 perfiles de 2 m.	1	39.0135.3

AIRPERFIL - Estructura vista suelo/pared o suelo/techo

Aluminio



Este sistema permite una visión global de todos los artículos que se expongan.

La perfilería vertical de aluminio tiene el canal longitudinal en la cara trasera, las tuercas quedan ocultas a la vista y los soportes de la balda poco visibles. Las baldas pueden ser reguladas a la altura deseada.

Las cartelas permiten utilizar baldas para madera o vidrio. Las baldas de madera pueden inclinarse hasta 38°.

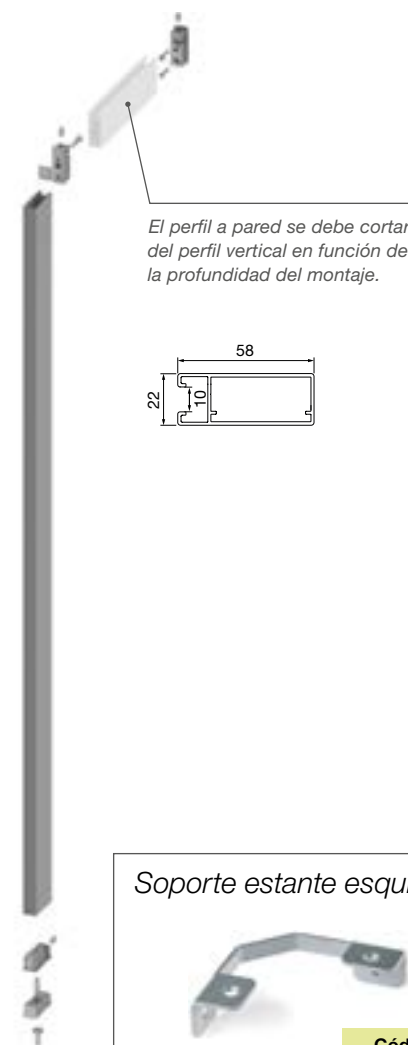
Kit perfil suelo/pared o suelo/techo

El perfil a pared se debe cortar del perfil vertical en función de la profundidad del montaje.

Contenido Kit perfil suelo/pared:

- 1- Perfil vertical 2700 mm. x 1
- 2- Suplemento pie x 1
- 3- Pie regulable + unión perfil x 1
- 4- Conector ángulo recto x 1
- 5- Soporte fijación pared x 1

Contenido accesorio techo/suelo:

- 2- Suplemento pie x 1
- 3- Pie regulable + unión perfil x 1

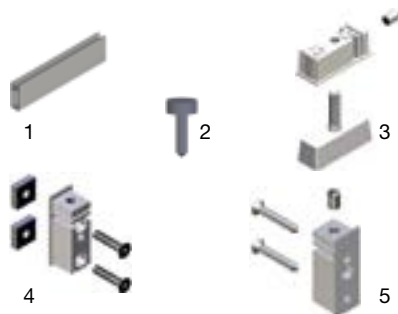

Los suplementos, conectores, soportes y pies son siempre en cromo mate.

Descripción	Código	Código			
		Blanco Mate	Plata Mate	Negro Mate	Antracita
Kit suelo/pared	1	30.0494.6	30.0496.1	30.0495.0	30.0016.5
Accesorio suelo/techo	1		30.0501.6		

Soportes barra armario

Fijación a perfil



Soporte barra armario



Descripción	Código	Código				
		Blanco Mate	Plata Mate	Negro Mate	Moka	Antracita
Fijación para soporte	1		30.0512.3			
Soporte barra armario	1	30.0471.4	30.0472.5	30.0473.6	30.0363.1	30.0017.6

Ver barras de armario en pág. 436

Soporte estante esquina

Código	
1	01.2751.1

Kit 2 Cartelas

Cartela Madera

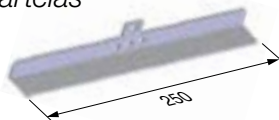

Cartela Vidrio hasta 10 mm.



Incluyen los soportes fijación a perfil.

Descripción	Código	Código		
		Blanco Mate	Negro Mate	Plata Mate
Kit 2 cartelas madera	1	30.0507.5	30.0508.6	30.0509.0
Kit 2 cartelas vidrio	1			30.0510.1

LAMASISTEM - Instalación Comercial

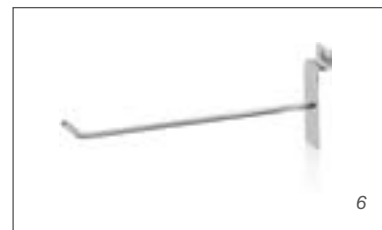
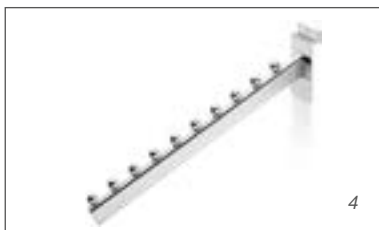
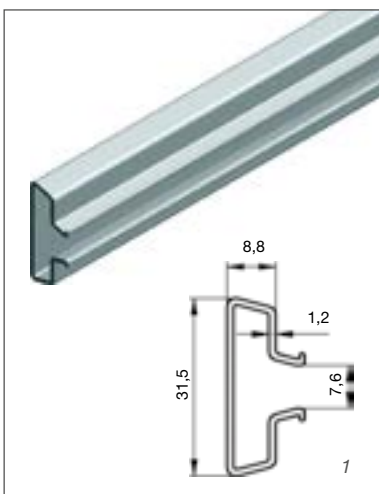

Descripción	Medida	Grosor vidrio	Código	Código	
				Aluminio	Cromo Brillo
1 Kit 4 perfiles verticales	300 cm.	1	39.2509.0		
2 Jgo. 2 cartelas	25 cm.	1		N	30.0653.6
3 Jgo. 2 cartelas para vidrio	11 cm.	8-10 mm.	1		N 30.0654.7
4 Perroquet colgador inclinado	30 cm.	1			30.0243.0
5 Colgador plano	30 cm.	1			30.0244.1
6 Colgador de varilla	20 cm.	1			30.0238.2
7 Barra colgador	90x30 cm.	1			30.0247.4



Pantalonero de varillas móviles de **extracción total**

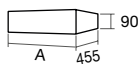

Incluye marco con guías ocultas de extracción total.

Jgo. de 4 clips para instalar frentes de madera.

Jgo. de 4 varillas móviles con goma antideslizante.

			Código	
Ancho ajustable (A)	Nº Pantalones		Antracita	
464 - 514	5	1		30.0562.3
564 - 614	6	1		30.0563.4
664 - 714	7	1		30.0564.5
764 - 814	8	1		30.0565.6
864 - 914	9	1		30.0566.7
964 - 1014	10	1		30.0567.8

Descripción		Antracita	
4 varillas adicionales	1		30.0568.9
Distanciador 25 mm.	1		30.0617.3
Jgo. 4 clips para fijar frente	1		30.0618.4

Bandeja multifunción con compartimentos de **extracción total**

Cuero



Incluye marco con guías ocultas de extracción total.

Jgo. de 4 clips para instalar frentes de madera.

			Código	
Ancho ajustable (A)		Antracita		
464 - 514	1		30.0570.0	
564 - 614	1		30.0571.1	
664 - 714	1		30.0572.2	
764 - 814	1		30.0573.3	
864 - 914	1		30.0574.4	
964 - 1014	1		30.0575.5	

Descripción		Antracita	
Distanciador 25 mm.	1		30.0617.3
Jgo. 4 clips para fijar frente	1		30.0618.4

Bandeja multifunción tipo joyero de **extracción total**

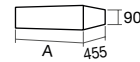
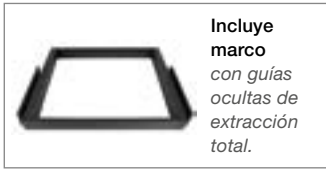

		Código	
Ancho ajustable (A)		Antracita	
464 - 514	1	N	30.0576.6
564 - 614	1	N	30.0577.7
664 - 714	1	N	30.0578.8
764 - 814	1	N	30.0579.9
864 - 914	1	N	30.0581.0
964 - 1014	1	N	30.0582.1

Descripción		Antracita	
Distanciador 25 mm.	1	N	30.0617.3
Jgo. 4 clips para fijar frente	1	N	30.0618.4

Perfilería para baldas de **extracción total**



Se sirven 2 perfiles de 990 mm. No incluye el tablero.

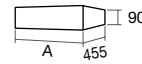

		Código	
Ancho ajustable (A)		Antracita	
464 - 514	1	N	30.0603.0
564 - 614	1	N	30.0604.1
664 - 714	1	N	30.0605.2
764 - 814	1	N	30.0606.3
864 - 914	1	N	30.0607.4
964 - 1014	1	N	30.0608.5

Descripción		Antracita	
Distanciador 25 mm.	1	N	30.0617.3
Jgo. 4 clips para fijar frente	1	N	30.0618.4

Cesto multifunción de **extracción total**

Cuero



		Código	
Ancho ajustable (A)		Antracita	
464 - 514	1	N	30.0583.2
564 - 614	1	N	30.0584.3
664 - 714	1	N	30.0585.4
764 - 814	1	N	30.0586.5
864 - 914	1	N	30.0587.6
964 - 1014	1	N	30.0588.7

Descripción		Antracita	
Distanciador 25 mm.	1	N	30.0617.3
Jgo. 4 clips para fijar frente	1	N	30.0618.4

Cesto de multifunción de **extracción total**

Alambre

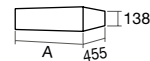
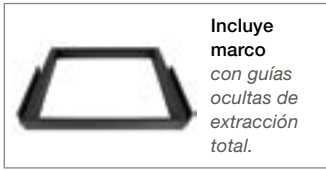

		Código	
Ancho ajustable (A)		Antracita	
464 - 514	1	N	30.0589.8
564 - 614	1	N	30.0590.9
664 - 714	1	N	30.0592.0
764 - 814	1	N	30.0593.1
864 - 914	1	N	30.0594.2
964 - 1014	1	N	30.0595.3

Descripción		Antracita	
Distanciador 25 mm.	1	N	30.0617.3
Jgo. 4 clips para fijar frente	1	N	30.0618.4

Zapatero de **extracción total**

Alambre

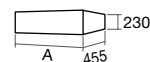
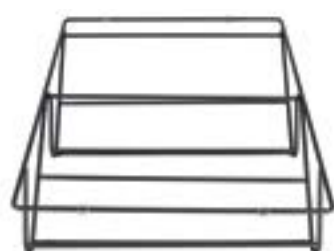

		Código	
Ancho ajustable (A)		Antracita	
464 - 514	1	N	30.0596.4
564 - 614	1	N	30.0597.5
664 - 714	1	N	30.0598.6
764 - 814	1	N	30.0599.7
864 - 914	1	N	30.0600.8
964 - 1014	1	N	30.0601.9

Descripción		Antracita	
Distanciador 25 mm.	1	N	30.0617.3
Jgo. 4 clips para fijar frente	1	N	30.0618.4

Pantalonero de **extracción total** y cierre amortiguado

Instalación bajo tablero.
Para 10 prendas.

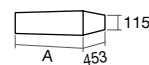

Código			
Ancho (A)			Antracita
355	1		N 30.0609.6

Pantalonero de **extracción total** y cierre amortiguado

Instalación lateral.
Para 9 prendas.



Código			
Ancho (A)	Mano		Antracita
355	Izquierda	1	N 30.0611.8
355	Derecha	1	N 30.0612.9

Pantalonero doble de **extracción total** y cierre amortiguado

Instalación bajo tablero.
Para 20 prendas.

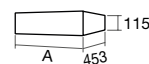

Código			
Ancho (A)			Antracita
670	1		N 30.0610.7

Corbatero de **extracción total** y cierre amortiguado

Instalación lateral.
Para 9 prendas.

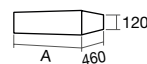

Código			
Ancho (A)	Mano		Antracita
170	Izquierda	1	N 30.0614.0
170	Derecha	1	N 30.0615.1

Soporte para perchas de **extracción total** y cierre amortiguado

Instalación bajo tablero.

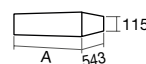

Código			
Ancho (A)	Mano		Antracita
115	Reversible	1	N 30.0616.2

Caja organizadora de 5 compartimentos
Cuero



					Código
Ancho	Fondo	Alto		Antracita	
155	358	50	1		30.0644.8

Caja organizadora de 4 compartimentos (1 con tapa)
Cuero



					Código
Ancho	Fondo	Alto		Antracita	
155	358	50	1		30.0647.0

Caja relojero con tapa
Cuero



					Código
Ancho	Fondo	Alto		Antracita	
155	358	50	1		30.0645.9

Caja tipo joyero
Cuero



					Código
Ancho	Fondo	Alto		Antracita	
155	358	50	1		30.0648.1

Caja **baja sin tapa**
Tela



				Código	
Ancho	Fondo	Alto		Antracita	
290	400	80	1		30.0627.2
350	400	80	1		30.0625.0
290	400	120	1		30.0628.3
350	400	120	1		30.0626.1

Caja **baja con tapa**
Tela



				Código	
Ancho	Fondo	Alto		Antracita	
350	400	120	1		30.0630.5
350	400	170	1		30.0631.6
350	400	240	1		30.0632.7

Caja **alta con tapa**
Tela



				Código	
Ancho	Fondo	Alto		Antracita	
250	400	240	1		30.0629.4
350	450	240	1		30.0633.8

Caja **baja sin tapa**
Cuero



				Código	
Ancho	Fondo	Alto		Antracita	
290	400	80	1		30.0637.1
350	400	80	1		30.0634.9
290	400	120	1		30.0638.2
350	400	120	1		30.0636.0

Caja **baja con tapa**
Cuero

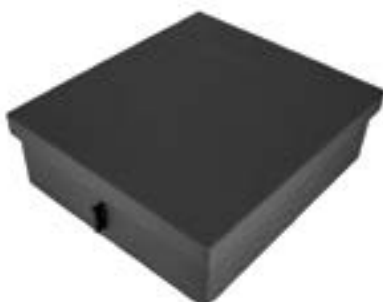

				Código	
Ancho	Fondo	Alto		Antracita	
250	400	240	1		30.0639.3
350	400	120	1		30.0640.4
350	400	170	1		30.0641.5

Caja **alta con tapa**
Cuero



				Código	
Ancho	Fondo	Alto		Antracita	
250	400	240	1		30.0642.6
350	450	240	1		30.0643.7

Perchero abatible de **cierre amortiguado**



Instalación paneles laterales.
Peso soportado: Máx. 10 Kg.

Ancho ajustable		Código
Antracita		Antracita
de 450 a 600	1	N 30.0619.5
de 600 a 830	1	N 30.0620.6
de 830 a 1150	1	N 30.0621.7

Zapatero giratorio con **bandejas**



Instalación bajo tablero y basal.
Peso soportado: Máx. 12 Kg.

Altura ajustable		Código
Antracita		Antracita
de 1875 a 1945	1	N 30.0622.8

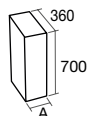

Distanciador de regrueso



Permite salvar las bisagras.

Grueso		Código
Antracita		Antracita
25	1	N 30.0617.3

Rollo autoadhesivo **protector**



Protege y embellece la madera.

Ancho		Largo		Código
Antracita		Antracita		Antracita
1,22 m.	50 m.	1		N 30.0623.9

Barras y soportes
Aluminio



Descripción		Código
Antracita		Antracita
1 Barra recta 2 m.	1	N 30.0018.7
1 Barra curva 90° 1+1 m.	1	N 30.0031.9
2 Soporte	1	N 30.0017.6
3 Soporte	1	N 30.0019.8
4 Soporte	1	N 30.0480.6

Para **9 pantalones** fijación superior con bandeja portaobjetos

Acero

MENAGE
CONFORT



SISTEMA
REVERSIBLE

Incorpora fundas antideslizantes en los soportes.
Guía extracción total con cierre amortiguado.

		Código	
Medidas		Cromo Mate	Antracita
353 x 116 x 490 mm.	1	30.0294.2	30.0101.2

Para **18 pantalones** fijación superior con bandeja portaobjetos

Acero

MENAGE
CONFORT



Incorpora fundas antideslizantes en los soportes.
Guía extracción total con cierre amortiguado.

		Código	
Medidas		Cromo Mate	Antracita
680 x 97 x 490 mm.	1	30.0295.3	30.0085.8

Kit Soporte pantalones extraíble

Acero

MENAGE
CONFORT

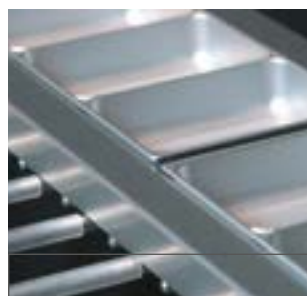

Bandeja accesorios incluidas en el Kit.

1/10

Cromo 01.2289.1
Antracita 01.0023.1



Con sistema de cierre amortiguado. Carga dinámica 30 kg.
Anchura adaptable. Guías correderas de bolas de acero, extracción total. Acabado resina plata satinada. Fondo interior mínimo de mueble 485 mm.

Si se precisa desplazar el accesorio para salvar puerta o similar, solicitar la cantidad necesaria de espaciadores; Cód. 01.2292.4.

El kit esta formado por todos los accesorios necesarios.

		Código		
Interior Mueble	Uds. pantalones		Cromo Mate	Antracita
500-550	8	1	01.2697.3	01.0024.2
550-590	9	1	01.2698.4	01.0026.4
590-600	10	1	01.2699.5	01.0027.5
600-650	10	1	01.2700.6	01.0029.7
650-690	11	1	01.2701.0	01.0030.8
690-700	12	1	01.2702.1	01.0031.9
700-750	12	1	01.2703.2	01.0034.1
750-790	13	1	01.2704.3	01.0035.2
790-800	14	1	01.2705.4	01.0036.3
800-850	14	1	01.2706.5	01.0038.5
850-890	15	1	01.2707.6	01.0039.6
890-900	16	1	01.2708.0	01.0040.7
Espaciador salvabisagras de 10 mm.		1/50	01.2292.4	01.0019.8

Ver también...

7.01 Colección de
Armario Serie Moka
Página 566



Para **11 pantalones** fijación superior
Acero



SISTEMA REVERSIBLE

Guía con posición vertical.
3 cuerpos. Extracción total.

Código		
Medidas		Cromo Brillo
350 x 125 x 485	1/10	30.0149.4

Para **9 pantalones** fijación superior
Acero



MENAGE CONFORT

SISTEMA REVERSIBLE

Guía con posición horizontal.
3 cuerpos. Extracción total.
Incorpora fundas antideslizantes en los soportes

Código		
Medidas		Cromo Brillo
330 x 95 x 470	1/2	30.0249.6

Para **18 pantalones** fijación superior
Acero



Guía con posición vertical.
3 cuerpos. Extracción total.

Código		
Medidas		Cromo Brillo
662 x 42 x 440	1/4	30.0248.5

Para **10 pantalones** fijación lateral
Acero



MENAGE CONFORT

SISTEMA REVERSIBLE

Elemento extraíble.

Incorpora fundas antideslizantes en los soportes

Código		
Medidas		Cromo Mate
480 x 120 x 495	1/2	30.0079.4

Extraíble sin frontal

Acero



Cód. 01.3607.3
Juego escuadras
fijación guía a basal:
Permite fijar a la base
del mueble las guías
laterales incluidas en el
módulo (opcional).

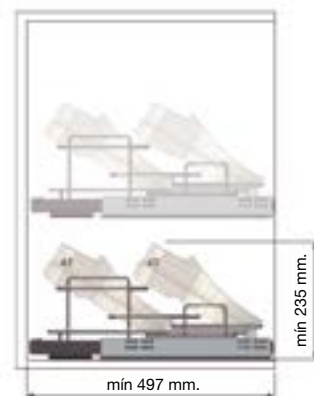

Descripción	Código	Código	
		Cromo Mate / Cromo	Antracita
Zapatero extraíble de 45 a 65 cm.	1	30.0377.1	30.0089.1
Zapatero extraíble de 64 a 100 cm.	1	30.0378.2	30.0090.2
Espaciador (opcional)	1	01.2292.4	01.0019.8
Jgo. escuadras fijación guía a basal (opcional)	1	01.3607.3	

Extraíble con frontal

Acero



Cód. 01.3607.3
Juego escuadras
fijación guía a basal:
Permite fijar a la base
del mueble las guías
laterales incluidas en el
módulo (opcional).

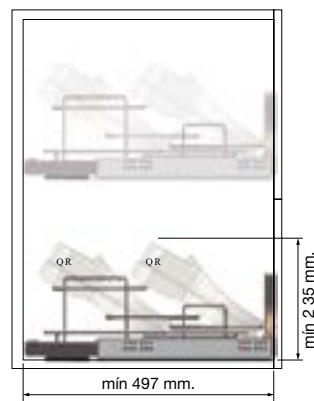

Carga máxima 30 Kg.

Descripción	Código	Código	
		Cromo Mate / Cromo	Antracita
Zapatero extraíble de 45 a 65 cm.	1	30.0381.5	30.0091.3
Zapatero extraíble de 64 a 100 cm.	1	30.0382.6	30.0092.4
Espaciador (opcional)	1	01.2292.4	01.0019.8
Jgo. escuadras fijación guía a basal (opcional)	1	01.3607.3	

Ver también...

7.01 Los zapateros de
la colección de armario
serie Moka

Página 567



Juego soporte zapatos extraíble

Acero

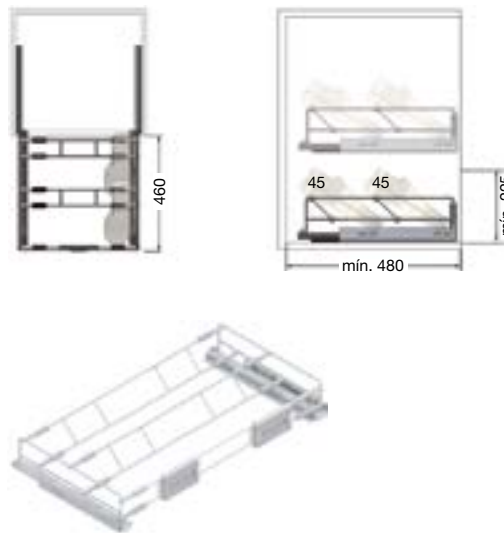

Con sistema de cierre amortiguado.

Carga dinámica 30 Kg.

Anchura adaptable. Guías correderas de bolas de acero, extracción total. Acabado resina plata satinada. Fondo interior mínimo de mueble 485 mm.

Adaptable para tableros de melamina de 16 / 19 mm. Si se precisa desplazar el accesorio para salvar puerta o similar, solicitar la cantidad necesaria de espaciadores; Cód. 01.2292.4

				Código
Interior Mueble	Alto	Fondo		Cromo Mate
400 a 500	137	476,5	1	01.2992.4
500 a 600	137	476,5	1	01.2993.5
600 a 700	137	476,5	1	01.2994.6
700 a 800	137	476,5	1	01.2995.0
800 a 900	137	476,5	1	01.2996.1
900 a 1.000	137	476,5	1	01.2997.2
Espaciador salvabisagras de 9,5 mm.				1/50 01.2292.4

Extraíble sin frontal

Acero



			Código
Mueble		Cromo	
De 40 a 60 cm.	1/5	30.0221.6	
De 60 a 100 cm.	1/5	30.0222.0	

Juego de laterales de zapatero

Plástico

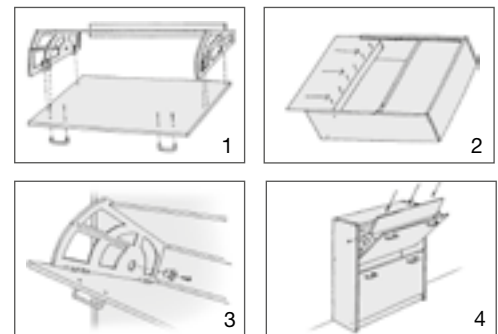
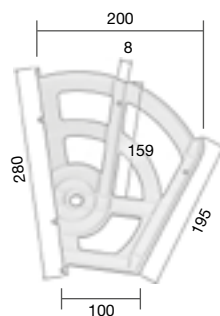

			Código
Descripción		Marrón	
Laterales	1/50	30.0063.2	

Bastidor extraíble zapatero
Acero

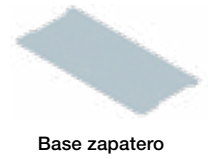
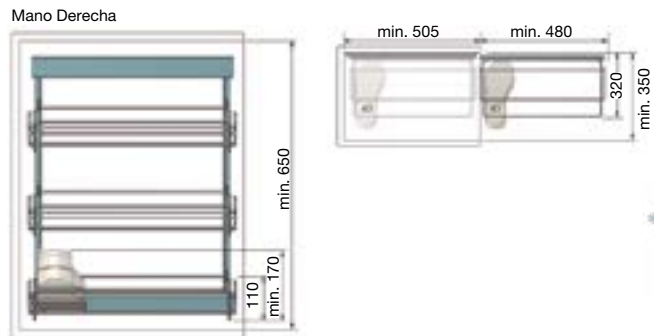

Base zapatero

Descripción	Mano	Medidas	Cubo	Código	
				Cromo	Gris Metalizado
Soporte zapatero	Derecho	320 x 600 x 495 mm.	1	30.0389.6	
Soporte zapatero	Izquierdo	320 x 600 x 495 mm.	1	30.0390.0	
Base zapatero (opcional)		490 x 226 x 1,5 mm.	1		30.0321.1

Bastidor articulado
Acero

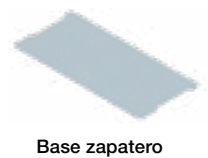
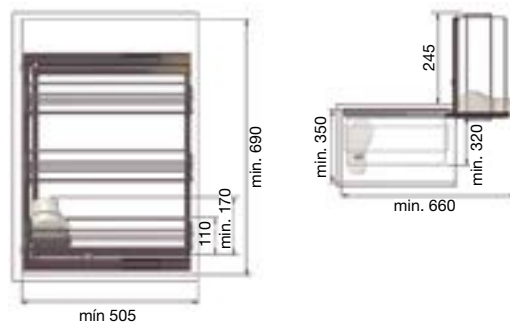

Base zapatero

Reversible. Carga máxima 30 kg. 3 cestas.

Descripción	Medidas	Cubo	Código	
			Cromo	Gris Metalizado
Soporte zapatero	320 x 640 x 495 mm.	1	30.0391.1	
Base zapatero (opcional)	490 x 226 x 1,5 mm.	1		30.0321.1

Frontal o lateral fijo extensible
Acero

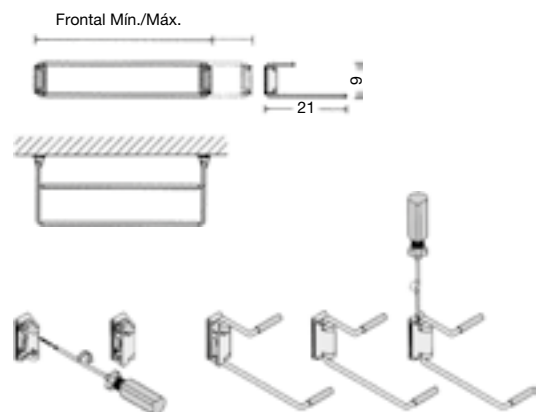
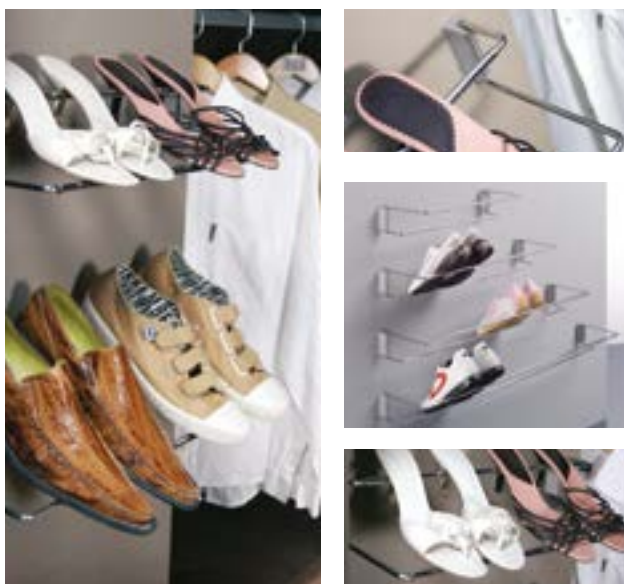

Montaje frontal o lateral. Formado por 2 tubos. Puede cortarse para adaptarlo a medidas inferiores.

Mueble	Cubo	Código	
		Cromo	Gris Metalizado
48 a 83 cm.	1/6	30.0053.6	
83 a 113 cm.	1/6	30.0054.0	

Juego de guías para estante extraíble
Acero



Carga dinámica 30 Kg.

Anchura adaptable.

Guías correderas de bolas de acero, extracción total.

Fondo interior mínimo de mueble 485 mm.

Adaptable para tableros de melamina de 16 / 19 mm.

Si se precisa desplazar el accesorio para salvar puerta o similar solicitar la cantidad necesaria de espaciadores.

Descripción	📦	Código	
		Cromo Mate	Antracita
Juego estante extraíble	1/8	01.2276.2	30.0097.9
Espaciador salvabisagras de 10 mm	1/50	01.2292.4	01.0019.8

7.01 CORBATEROS Y CINTURONEROS

Corbatero cinturonerero extraíble
Acero

MENAGE
CONFORT



Mano	Medidas	Cubo	Código	
			Cromo Mate	Antracita
Derecho	70,5 x 55 x 458 mm.	1	30.0307.1	30.0082.5
Izquierdo	70,5 x 55 x 458 mm.	1	30.0308.2	30.0083.6

Descripción	Cubo	Código	
		Antracita	
Espaciador salvabisagras 10 mm.	1	30.0080.3	

Corbatero cinturonerero fijo
Acero

MENAGE
CONFORT

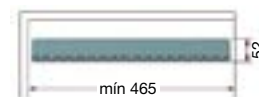

Medidas	Cubo	Código	
		Cromo Mate	Antracita
58 x 52 x 455 mm.	1	30.0306.0	30.0081.4

Extraíble de instalación lateral
Aluminio / Plástico

MENAGE
CONFORT

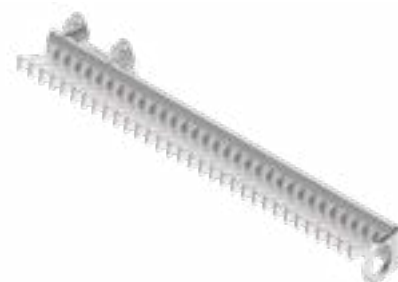
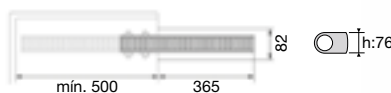

Medidas	Cubo	Código	
		Negro	Plata
500 x 82 x 76 mm.	1	30.0125.1	01.1997.3

Abatible de fijación lateral
Acero

MENAGE
CONFORT



Medidas	Cubo	Código	
		Cromo	
25,5 x 33 x 8 cm.	1/6	08.2003.2	

Corbatero - Cinturonero **extraíble amortiguado**



No guarda mano.

Medidas	Cubo	Código	
		Moka	
445 x 150 x 55 mm.	1	30.0465.5	

Espejo para interior de armario

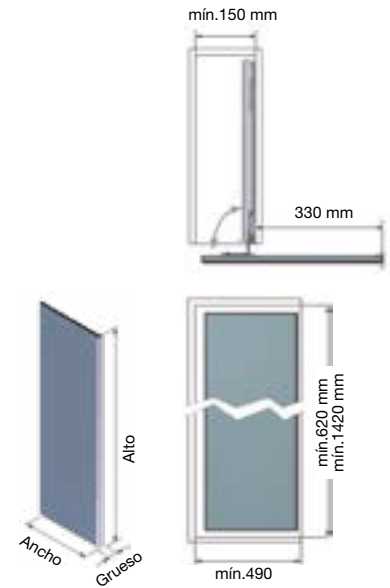

Guías correderas de bolas de acero extracción total con bisagras para girarlo. Marco de aluminio anodizado, color plata. Ancho interior mínimo de mueble 150 mm.

			Código		
Ancho	Alto	Grueso	Paquete	Plata	Antracita
480	596	50	1	P 01.2282.1	
480	1405	50	1	01.2283.2	01.0041.8

BARRAS ARMARIO

KARLO - Cuelga perchas extensible tipo trompeta
Acero



			Código	
Medida	Paquete	Niquelado		
25 cm.	1/10	30.0004.6		
30 cm.	1/10	30.0005.0		
35 cm.	1/10	30.0006.1		
40 cm.	1/10	30.0007.2		
45 cm.	1/10	30.0008.3		
50 cm.	1/10	30.0009.4		

DALK - Cuelga perchas extensible tipo trompeta
Acero/Plástico

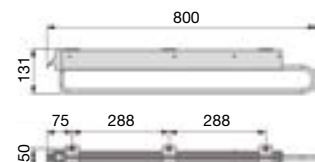

			Código	
Medida	Paquete	Niquelado		
80 cm.	1	30.0278.0		

Soporte de perchas extraíble
Acero

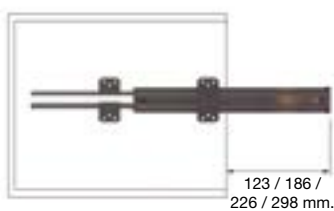

Carga dinámica 15 kg.

Ideado para armarios de poco fondo. Guías correderas de bolas de acero, extracción parcial.

Medida		Código	
		Plata Mate	Antracita
240 mm.	1/10	01.2262.2	30.0093.5
290 mm.	1/10	01.2263.3	30.0094.6
360 mm.	1/10	01.2264.4	30.0095.7
445 mm.	1/10	01.2265.5	30.0096.8

Soporte para perchas **extraíble amortiguado**

Aluminio



		Código	
Alto	Fondo		Moka
160 mm.	445 mm.	1	30.0464.4

NEW KERRI - Barra rectangular con antideslizante

Aluminio



Goma antideslizante

Con goma antideslizante en la parte superior que evita que las perchas resbalen, sin impedir su movilidad y reduciendo su ruido.



Barra curvada

		Código				
Descripción		Blanco Mate	Plata Mate	Negro Mate	Antracita	Moka
Barra recta 2 m.	1/2	30.0467.0	30.0470.3	30.0468.1	30.0018.7	30.0469.2
Barra curvada 1x1 m.	1/2	30.0027.5	30.0029.7	30.0028.6	30.0031.9	30.0030.8

Soporte lateral

Aluminio



Espesor soporte lateral de 6 mm. por soporte, a descontar de la barra.

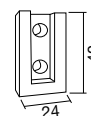

		Código				
Descripción		Blanco Mate	Plata Mate	Negro Mate	Antracita	Moka
Lateral	1/50	30.0471.4	30.0472.5	30.0473.6	30.0017.6	30.0363.1

Jgo. de 2 soportes a techo o lateral de fácil montaje

Aluminio



Fijación no incluida.

Cód. 25.3136.6
M-6x30 tablero de 20 mm.

Cód. 25.0242.0
M-6x40 tablero de 30 mm.

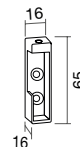

		Código				
Descripción		Blanco Mate	Plata Mate	Negro Mate	Antracita	Moka
2 soportes	1/50	30.0022.0	30.0024.2	30.0023.1	30.0026.4	30.0025.3

Soporte a techo

Aluminio



Fijación no incluida.

Cód. 25.0589.6
M-5x30 tablero de 20 mm.

Cód. 25.0236.5
M-5x40 tablero de 30 mm.

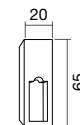

		Código				
Descripción		Blanco Mate	Plata Mate	Negro Mate	Antracita	Moka
Techo lateral	1/50	30.0474.0	30.0475.1	30.0477.3	30.0019.8	30.0476.2
Techo central	1/50	30.0478.4	30.0479.5	30.0481.0	30.0020.9	30.0480.6

JANI - Barra aluminio estriada ovalada de 28 x 15 mm.

Aluminio



Descripción	Largo	Caja	Código	
			Cromo Mate	
Barra recta	2 m.	1/10		30.0361.6
Barra recta*	4 m.	1/10	!	30.0360.5
Barra curva 90°	1x1 m.	10	!	30.0425.7

* Corte en 2 piezas para evitar recargo de transporte superior a 3 m.

Soporte fijación techo

Zamak



El espesor soporte lateral es de 1,3 mm. que deberemos descontar de la barra.

Descripción	Caja	Código	
		Cromo Mate	Gris Fosco
Central	1/10/250	30.0235.6	N 30.0666.8
Lateral	1/10/75	30.0236.0	

Soporte fijación lateral oreja

Acero

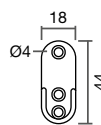

El espesor soporte lateral es de 3 mm. que deberemos descontar de la barra.

Caja	Código	
	Cromo Mate	Gris Fosco
10/250	30.0233.4	N 30.0667.9

Soporte techo barra angular

Plástico

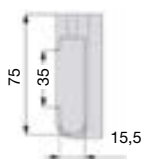

Permite realizar un montaje en ángulo de 90°. Incluye tornillería de fijación M-6



Caja	Código	
	Cromo Mate	
1/100		83.1668.1

Soporte fijación techo rectangular

Aluminio



Espesor soporte lateral de 2,5 mm. por soporte, a descontar de la barra

Fijación no incluida.

Cód. 25.0589.6
M-5x30 para tablero de 20 mm.

Cód. 25.0236.5
M-5x40 para tablero de 30 mm.



Descripción	Caja	Código	
		Cromo Mate	
Central	1		30.0339.5
Lateral	1		30.0338.4

Soporte esquina estante

En estantes en forma de ángulo se recomienda la instalación del soporte esquina para estante

Caja	Código	
	Plata	
1/20		01.2751.1

KAKO - Barra ovalada lisa

Acero

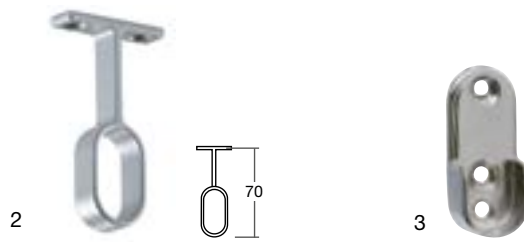

Descripción	Embalaje	Código		
		Niquelado 25 x 15 mm.	Niquelado 30 x 15 mm.	
1 Barra 2 m.	1/20	30.0020.1	1/15	30.0331.4
Barra 3 m.	1/20	30.0075.9	1/15	30.0077.0
2 Soporte Techo	1/10	30.0086.4	1/10/250	30.0333.6
3 Soporte Lateral*	10/250	30.0068.0	10/250	30.0068.0

* Espesor de 3,5 mm. por soporte, a descontar de la barra.

BRIAN - Barra redonda Ø19 mm.

Acero

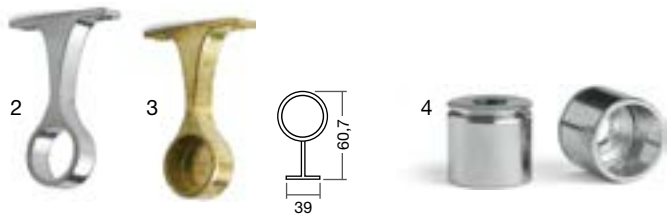

Descripción	Embalaje	Código	
		Niquelado	Dorado
1 Barra 2 m. Ø19 mm.	1/25	30.0117.0	30.0118.1
Barra 3 m. Ø19 mm.	1/25	30.0078.1	30.0079.2
2 Soporte Techo / Central	1/75	30.0023.4	30.0025.6
3 Soporte Techo / Lateral	1/75	30.0045.5	30.0024.5
4 Soporte Lateral*	10/100	30.0030.4	30.0028.2

* Espesor de 3,5 mm. por soporte, a descontar de la barra.

BRIDE - Barra redonda Ø12 mm.

Acero



* Espesor soporte lateral de 3 mm. por soporte, a descontar de la barra.

Descripción	Embalaje	Código
		Niquelado
1 Barra 2 m. Ø12 mm.	1/24	30.0021.2
Barra 3 m. Ø12 mm.	1/24	30.0022.3
2 Soporte Lateral *	10/200	30.0031.5

WARDROBE - Barra colgador con iluminación Led y activación por movimiento a 24V.

Aluminio

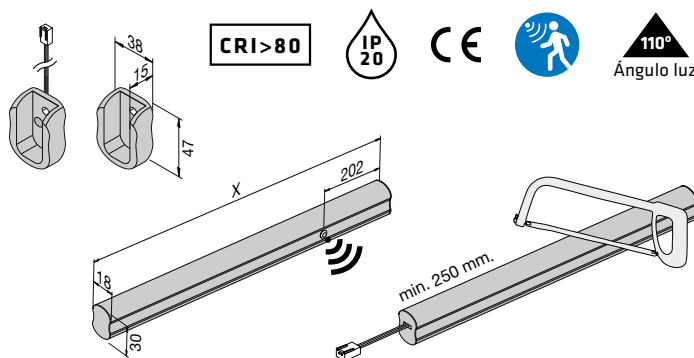
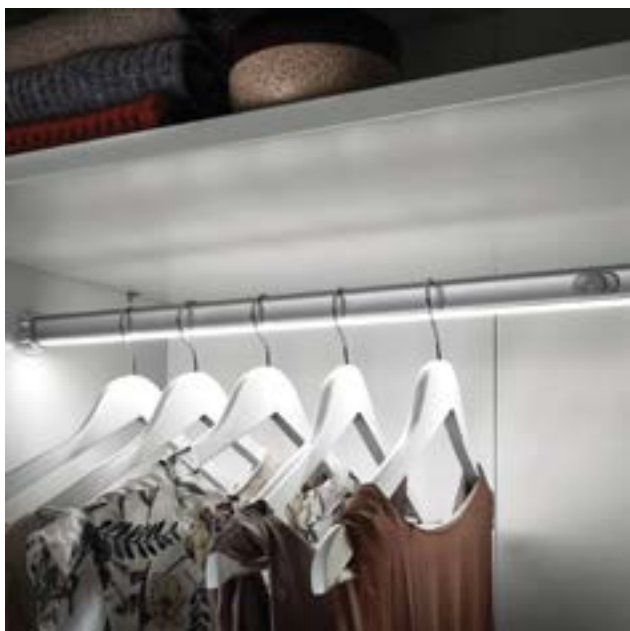
Hera
MADE IN GERMANY

Ideal para instalar en proyectos contract como hoteles, clínicas, residencias, etc. **Integra sensor de movimiento** con apagado automático (si no hay movimiento) en 30 segundos. **Se puede cortar** desde la toma de corriente a partir de 250 mm.

Características técnicas:

- Temperatura de color **blanco neutro** (Aprox. 4000K.)
- **Requiere fuente de alimentación.**

Incluye:

- Cable de alimentación 2,5 m.
- Soportes a pared.

Garantía:

Para el correcto funcionamiento y posible aplicación de la garantía todos los componentes de una instalación deben ser productos HERA.

Fuente de alimentación necesaria:

Con 12 salidas.
Incluye cable con enchufe de 2 m.



Wattios	Medidas	📦	Código
15W	121x45x17	1	87.0173.1
30W	151x41x31	1	87.0174.2
80W	185x60x31	1	N 87.0893.1

Código

(X) Longitud	Lumen	Potencia	📦	Cromo Mate
600 mm.	385 lm.	5,5 W.	1	87.0056.1
1000 mm.	665 lm.	9,5 W.	1	87.0057.2
1200 mm.	805 lm.	11,5 W.	1	87.0058.3

WARDROBE Q - Barra colgador con iluminación Led y activación por movimiento a 24V.

Aluminio

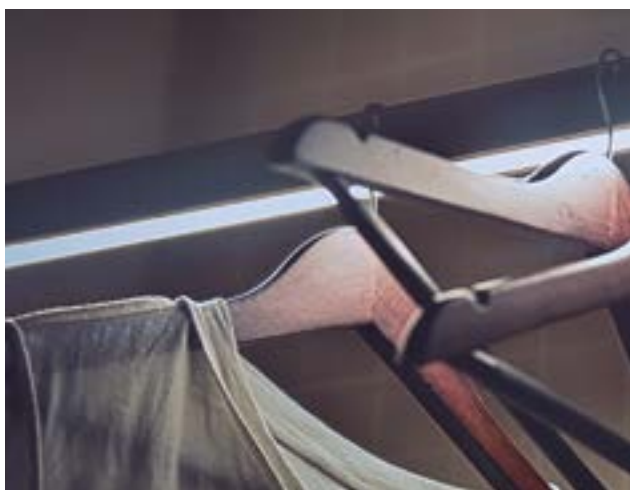
Hera
MADE IN GERMANY

Instalación estante

Instalación lateral

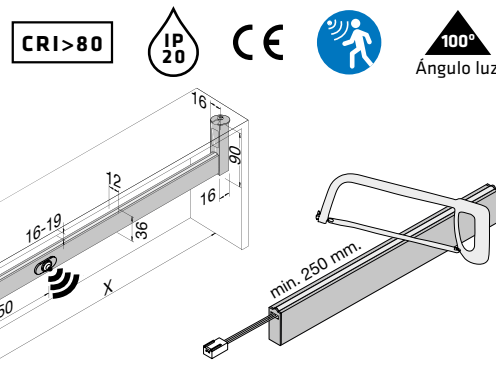

Integra sensor de movimiento con apagado automático (si no hay movimiento) en 30 segundos. **Se puede cortar** desde la toma de corriente a partir de 250 mm.

Características técnicas:

- Temperatura de color **blanco neutro** (Aprox. 4000K.)
- Los soportes permiten instalación lateral y bajo el estante.
- **Requiere fuente de alimentación.**

Incluye:

- Cable de alimentación 2,5 m.
- Soportes.

Garantía:

Para el correcto funcionamiento y posible aplicación de la garantía todos los componentes de una instalación deben ser productos HERA.

Fuente de alimentación necesaria:

Con 12 salidas.
Incluye cable con enchufe de 2 m.



Wattios	Medidas	📦	Código
15W	121x45x17	1	87.0173.1
30W	151x41x31	1	87.0174.2
80W	185x60x31	1	N 87.0893.1

Código

(X) Longitud	Lumen	Potencia	📦	Negro
600 mm.	385 lm.	4,7 W.	1	N 87.0894.2
1000 mm.	665 lm.	7,8 W.	1	N 87.0895.3
1200 mm.	805 lm.	9,3 W.	1	N 87.0896.4

LYTOS - Barra colgador iluminada con **batería recargable**

Aluminio

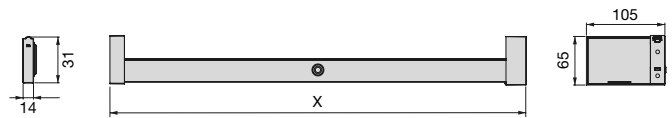

Dispone de batería extraíble recargable mediante un cargador de móvil de 5V DC 1A con clavija micro USB tipo B. Su sensor de movimiento integrado permite que la luminaria se enciende cuando detecta movimiento y se apague al no detectar movimiento transcurridos 15 segundos. Incluye soportes de fijación. Blanco natural 4.000 K.

Vídeo e instrucciones



(X) Longitud	Lumen	Nº Leds	Potencia	📦	Código	
					Moka	Plata Mate
408 a 558 mm.	33 lm.	30	0,6 W.	1	83.1746.2	83.1747.3
558 a 708 mm.	39 lm.	45	0,7 W.	1	83.1748.4	83.1749.5
708 a 858 mm.	50 lm.	60	0,9 W.	1	83.1750.6	83.1751.0
858 a 1008 mm.	55 lm.	75	1 W.	1	83.1752.1	83.1753.2
1008 a 1158 mm.	66 lm.	90	1,2 W.	1	N 83.1807.1	83.1755.4

Percha con mango
Acero



Código	
Medida	Cromado
45 x 78,5 cm.	30.0072.4

Soporte trajes 3 posiciones abatible
Acero

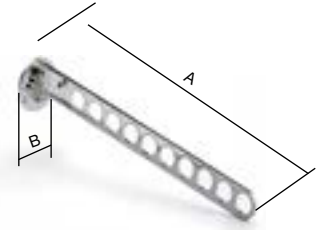

Código				
A	B	Orificios	Cromado	
290	75	6	1/6	30.0279.1
420	75	10	1/6	30.0128.4

Protector mangas / Soporte traje
Acero

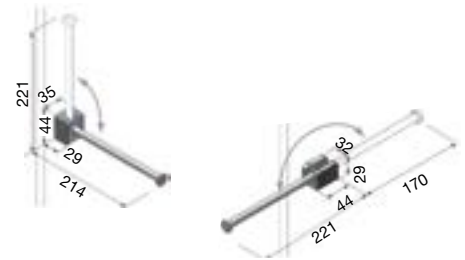

Doble función según colocación.

Código		
	Gris Metalizado	Antracita
1/10	01.2284.3	30.0099.0

Colgador retráctil embutido para perchas
Zamak / Acero

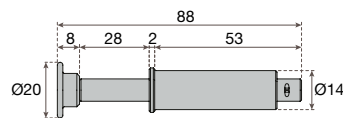

Grosor mínimo 20 mm.

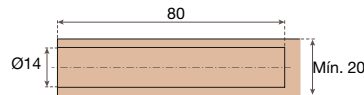

Código			
	Tapa Moka		Tapa Níquel
1/20	P N 30.0261.8	20	N 30.0259.6

ECONÓMICO - Colgador doble

Aluminio / Plástico

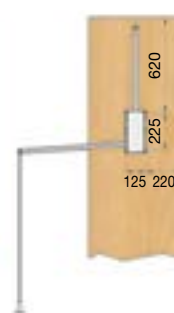

Con barras extensibles y una carga máxima de 10 Kg.

		Código	
Ancho ajustable		Cromo Mate	
650 a 920 mm.	1	30.0276.5	
880 a 1270 mm.	1	30.0277.6	

Colgador de 1 brazo

Resina Poliamídica / Acero Epoxi

**Capacidad de carga 12 Kg.**

Barra para colgar que permite utilizar los espacios superiores de los armarios, evitando el peligro que suponen las escaleras. Baja parando en la posición carga-descarga y sube suavemente a su posición original. Construido en poliamida y acero barnizado "epoxi". Incluye la tornillería necesaria para su colocación. No contiene aceite.



Distanciador regrueso 19 mm. para colgador.

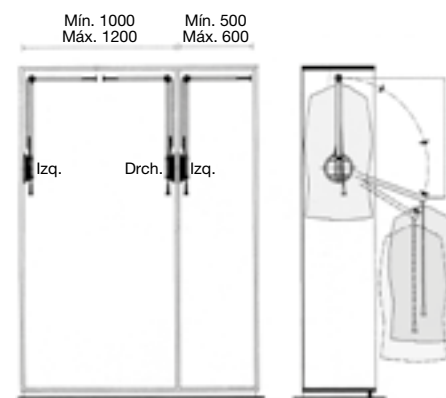
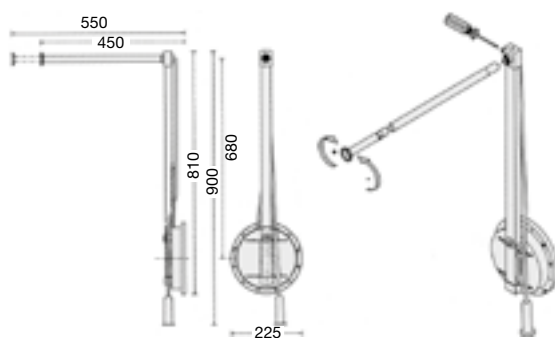

		Código	
Descripción		Cromo Mate	
Colgador 1 brazo Derecha	1/12	30.0048.1	
Colgador 1 brazo Izquierda	1/12	30.0049.2	
Distanciador regrueso 19 mm.	1/36	30.0150.5	

LIFT - Colgador doble

Resina Poliamídica / Acero Epoxi



Distanciador regrueso 22 mm. para colgador .

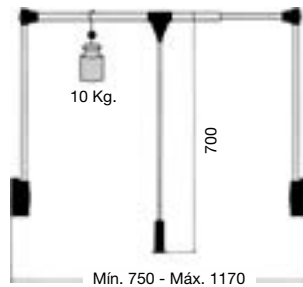

Capacidad de carga 10 Kg.
Colgador básico de la gama. Retorno a la parte superior regulado por un dispositivo hidráulico. Provisto de un portatrajes que permite el apoyo provisional de las prendas. Construido en resina poliamídica y acero barnizado "epoxi". Incluye la tornillería necesaria para su colocación. No contiene aceite.

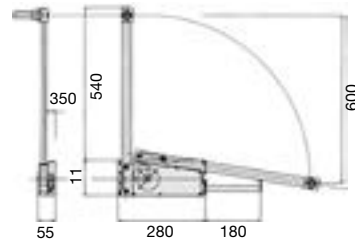

Descripción	Código
Colgador doble	30.0146.1
Distanciador regrueso 22 mm.	30.0151.6

SUPERLIFT - Colgador doble con regulación

Resina Poliamídica / Acero Epoxi



Regulador de presión.



Distanciador regrueso 22 mm. para colgador.

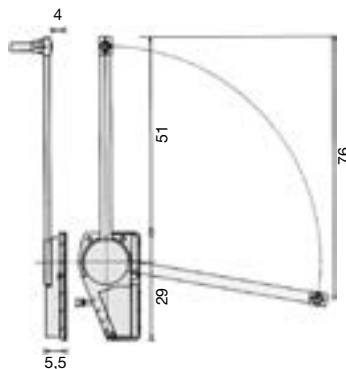

Capacidad de carga regulable entre 12 y 18 Kg.

El modelo más moderno de Ambos. Retorno a la parte superior regulado por un dispositivo hidráulico que funciona con un fluido especial. Fácil montaje para armarios en serie gracias a la perforación "System 32". Con un moderno diseño y completamente carenado, es la única barra de colgador basculante dotada de un dispositivo regulador de potencia que se adapta a los pesos de las diversas prendas. Construido en resina poliamídica y acero barnizado "epoxi". Incluye la tornillería necesaria para su colocación.

No contiene aceite.

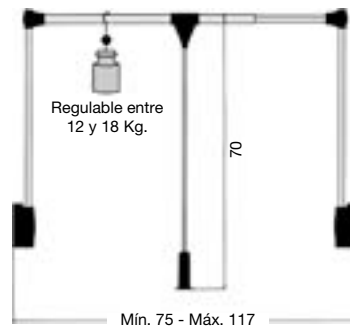

Descripción	Código
Colgador doble con regulación	30.0061.0
Distanciador regrueso 22 mm.	30.0152.0